

# YG-1 ИНСТРУМЕНТАЛЬНАЯ ОСНАСТКА

## ТОНКИЕ ЦАНГОВЫЕ ПАТРОНЫ SK

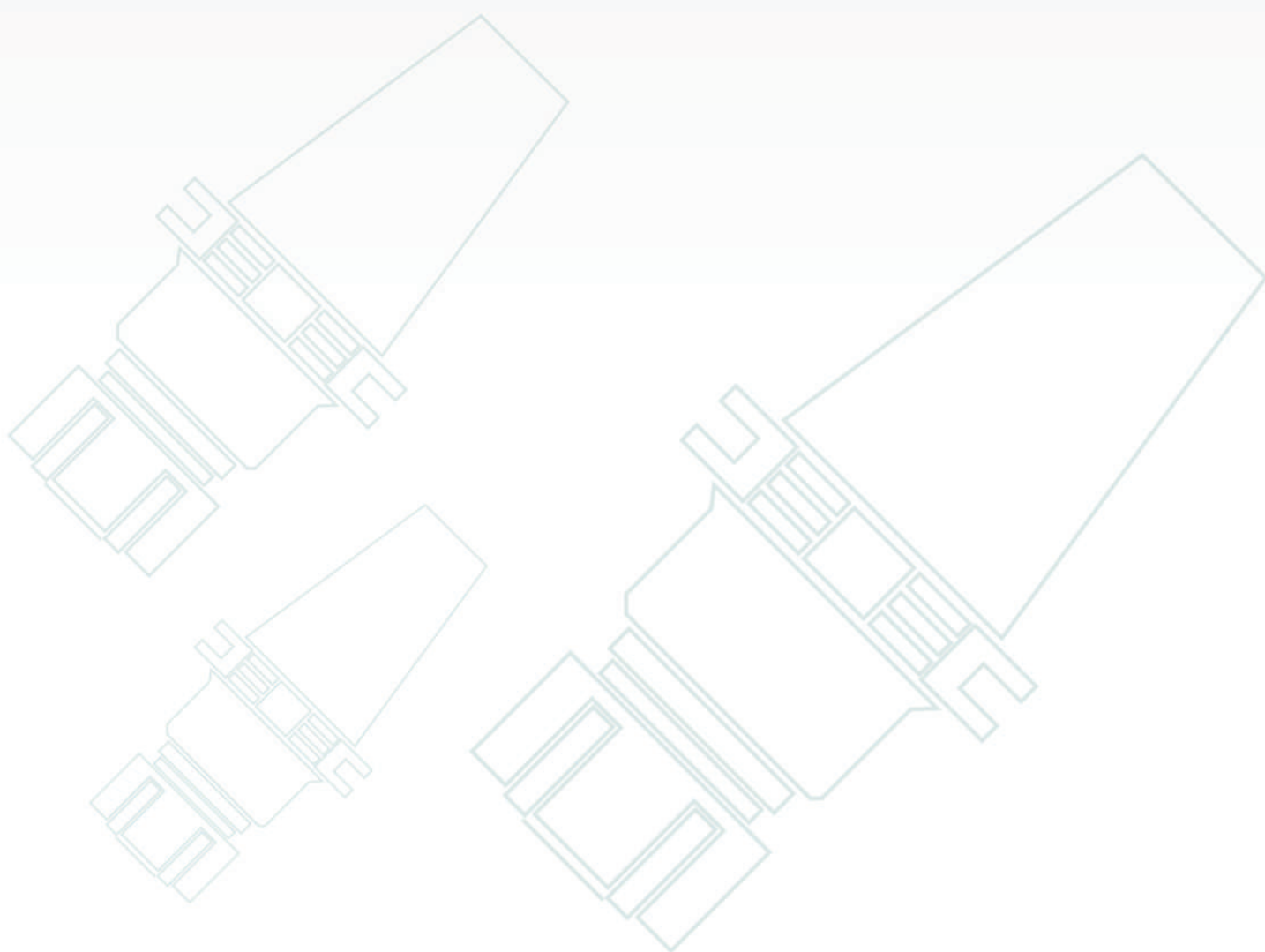



**СВТ (ВТ ДВОЙНОЙ КОНТАКТ)**

**JIS B6339/MAS 403-BT**

**DIN 69893/ISO 12164-1-HSK**

**ISO 20/25**

**ЦИЛИНДРИЧЕСКИЙ-К**

**АКСЕССУАРЫ И ЗАПЧАСТИ  
ГАЙКИ**

# ТОНКИЕ ЦАНГОВЫЕ ПАТРОНЫ SK

## ТОНКИЕ ЦАНГОВЫЕ ПАТРОНЫ SK

SKA

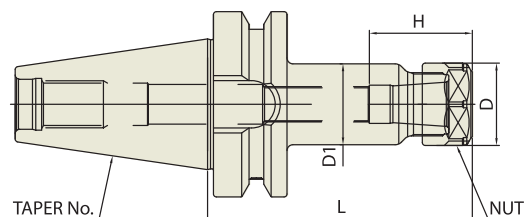

### ■ СВТ (ВТ ДВОЙНОЙ КОНТАКТ)

CBT	Taper Accuracy AT3	G Value 2.5	RPM 25,000	Coolant System AD
-----	-----------------------	----------------	---------------	----------------------

Unit : mm

КОНУС No.	МОДЕЛЬ	АРТИКУЛ	ДИАП. ЗАЖИМА	L	D	D1	H	ЦАНГА	ВЕС (Kg)
30	CBT30-SKA06-60	P2775701	1.8 - 6.0	60	20	19.5	31	SKC6	0.70
	CBT30-SKA06-90	P2775702	1.8 - 6.0	90	20	19.5	31	SKC6	0.80
	CBT30-SKA10-60	P2775703	1.75 - 10.0	60	28	27.5	35	SKC10	0.90
	CBT30-SKA10-90	P2775704	1.75 - 10.0	90	28	27.5	35	SKC10	1.00
	CBT30-SKA13-60	P2775705	2.75 - 13.0	60	33	33	43.6	SKC13	1.00
	CBT30-SKA13-90	P2775706	2.75 - 13.0	90	33	33	43.6	SKC13	1.10
	CBT30-SKA16-60	P2775707	2.75 - 16.0	60	40	40	52	SKC16	1.10
	CBT30-SKA16-90	P2775708	2.75 - 16.0	90	40	40	52	SKC16	1.20
	CBT30-SKA20-60	P2775709	3.5 - 20.0	60	48.5	40	59.6	SKC20	1.30
	CBT30-SKA20-90	P2775710	3.5 - 20.0	90	48.5	40	59.6	SKC20	1.40
40	CBT30-SKA25-90	P2775711	16.0 - 25.4	90	55	45	63.4	SKC25	1.50
	CBT40-SKA06-90	P2775712	1.8 - 6.0	90	20	19.5	31	SKC6	1.10
	CBT40-SKA06-120	P2775713	1.8 - 6.0	120	20	19.5	31	SKC6	1.40
	CBT40-SKA06-150	P2775714	1.8 - 6.0	150	20	19.5	31	SKC6	1.50
	CBT40-SKA10-90	P2775715	1.75 - 10.0	90	28	27.5	35	SKC10	1.20
	CBT40-SKA10-120	P2775716	1.75 - 10.0	120	28	27.5	35	SKC10	1.40
	CBT40-SKA10-150	P2775717	1.75 - 10.0	150	28	27.5	35	SKC10	1.60
	CBT40-SKA13-90	P2775718	2.75 - 13.0	90	33	33	43.6	SKC13	1.40
	CBT40-SKA13-120	P2775719	2.75 - 13.0	120	33	33	43.6	SKC13	1.60
	CBT40-SKA13-150	P2775720	2.75 - 13.0	150	33	33	43.6	SKC13	1.80
	CBT40-SKA16-90	P2775721	2.75 - 16.0	90	40	40	52	SKC16	1.50
	CBT40-SKA16-120	P2775722	2.75 - 16.0	120	40	40	52	SKC16	1.70
	CBT40-SKA16-150	P2775723	2.75 - 16.0	150	40	40	52	SKC16	1.90
	CBT40-SKA20-90	P2775724	3.5 - 20.0	90	48.5	48.5	59.6	SKC20	1.60
	CBT40-SKA20-120	P2775725	3.5 - 20.0	120	48.5	48.5	59.6	SKC20	2.00
	CBT40-SKA20-150	P2775726	3.5 - 20.0	150	48.5	48.5	59.6	SKC20	2.40
	CBT40-SKA25-90	P2775727	16.0 - 25.4	90	55	55	63.4	SKC25	1.80
	CBT40-SKA25-120	P2775728	16.0 - 25.4	120	55	55	63.4	SKC25	2.00
	CBT40-SKA25-150	P2775729	16.0 - 25.4	150	55	55	63.4	SKC25	2.30

## ТОНКИЕ ЦАНГОВЫЕ ПАТРОНЫ SK

SKA

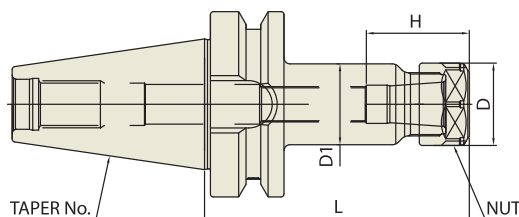

### ■ CBT (ВТ ДВОЙНОЙ КОНТАКТ)

CBT	Taper Accuracy <b>AT3</b>	G Value <b>2.5</b>	RPM <b>25,000</b>	Coolant System <b>AD</b>
-----	------------------------------	-----------------------	----------------------	-----------------------------

Unit : mm

КОНУС No.	МОДЕЛЬ	АРТИКУЛ	ДИАП. ЗАЖИМА	L	D	D1	H	ЦАНГА	ВЕС (Kg)
50	CBT50-SKA06-105	P2775730	1.8 - 6.0	105	20	19.5	31	SKC6	3.80
	CBT50-SKA06-135	P2775731	1.8 - 6.0	135	20	19.5	31	SKC6	3.90
	CBT50-SKA06-165	P2775732	1.8 - 6.0	165	20	19.5	31	SKC6	4.00
	CBT50-SKA06-195	P2775733	1.8 - 6.0	195	20	19.5	31	SKC6	4.20
	CBT50-SKA10-105	P2775734	1.75 - 10.0	105	28	27.5	35	SKC10	4.20
	CBT50-SKA10-135	P2775735	1.75 - 10.0	135	28	27.5	35	SKC10	4.40
	CBT50-SKA10-165	P2775736	1.75 - 10.0	165	28	27.5	35	SKC10	4.60
	CBT50-SKA10-195	P2775737	1.75 - 10.0	195	28	27.5	35	SKC10	4.80
	CBT50-SKA13-105	P2775738	2.75 - 13.0	105	33	33	43.6	SKC13	4.50
	CBT50-SKA13-135	P2775739	2.75 - 13.0	135	33	33	43.6	SKC13	4.70
	CBT50-SKA13-165	P2775740	2.75 - 13.0	165	33	33	43.6	SKC13	4.90
	CBT50-SKA13-195	P2775741	2.75 - 13.0	195	33	33	43.6	SKC13	5.20
	CBT50-SKA16-105	P2775742	2.75 - 16.0	105	40	40	52	SKC16	4.70
	CBT50-SKA16-135	P2775743	2.75 - 16.0	135	40	40	52	SKC16	4.90
	CBT50-SKA16-165	P2775744	2.75 - 16.0	165	40	40	52	SKC16	5.10
	CBT50-SKA16-195	P2775745	2.75 - 16.0	195	40	40	52	SKC16	5.50
	CBT50-SKA20-105	P2775746	3.5 - 20.0	105	48.5	48.5	59.6	SKC20	4.30
	CBT50-SKA20-135	P2775747	3.5 - 20.0	135	48.5	48.5	59.6	SKC20	4.60
	CBT50-SKA20-165	P2775748	3.5 - 20.0	165	48.5	48.5	59.6	SKC20	5.00
	CBT50-SKA20-195	P2775749	3.5 - 20.0	195	48.5	48.5	59.6	SKC20	5.40
CBT50-SKA25-105	P2775750	16.0 - 25.4	105	55	55	63.4	SKC25	5.20	
CBT50-SKA25-135	P2775751	16.0 - 25.4	135	55	55	63.4	SKC25	5.40	
CBT50-SKA25-165	P2775752	16.0 - 25.4	165	55	55	63.4	SKC25	5.60	
CBT50-SKA25-195	P2775753	16.0 - 25.4	195	55	55	63.4	SKC25	6.00	

# ТОНКИЕ ЦАНГОВЫЕ ПАТРОНЫ SK

## ТОНКИЕ ЦАНГОВЫЕ ПАТРОНЫ SK

SKA

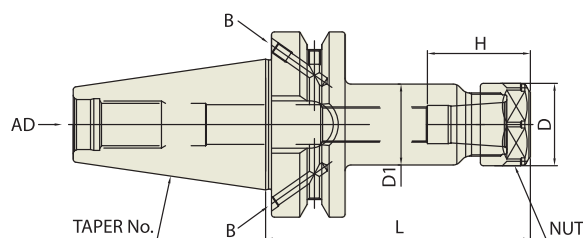

### ■ JIS B6339/MAS 403-BT

<b>JIS B6339</b> - BT	<b>Taper Accuracy</b> AT3	<b>G Value</b> 2.5	<b>RPM</b> 25,000	<b>Coolant System</b> AD or AD/B
--------------------------	------------------------------	-----------------------	----------------------	-------------------------------------

Unit : mm

КОНУС No.	МОДЕЛЬ	АРТИКУЛ	ДИАП. ЗАЖИМА	L	D	D1	H	ЦАНГА	ВЕС (Kg)
30	BT30-SKA06-60	P2775754A	1.8 - 6.0	60	20	19.5	31	SKC6	0.70
	BT30-SKA06-90	P2775755A	1.8 - 6.0	90	20	19.5	31	SKC6	0.80
	BT30-SKA10-60	P2775756A	1.75 - 10.0	60	28	27.5	35	SKC10	0.90
	BT30-SKA10-90	P2775757A	1.75 - 10.0	90	28	27.5	35	SKC10	1.00
	BT30-SKA13-60	P2775758A	2.75 - 13.0	60	33	33	43.6	SKC13	1.00
	BT30-SKA13-90	P2775759A	2.75 - 13.0	90	33	33	43.6	SKC13	1.10
	BT30-SKA16-60	P2775760A	2.75 - 16.0	60	40	40	52	SKC16	1.10
	BT30-SKA16-90	P2775761A	2.75 - 16.0	90	40	40	52	SKC16	1.20
	BT30-SKA20-60	P2775762A	3.5 - 20.0	60	40	48.5	59.6	SKC20	1.30
	BT30-SKA20-90	P2775763A	3.5 - 20.0	90	40	48.5	59.6	SKC20	1.40
40	BT30-SKA25-90	P2775764A	16.0 - 25.4	90	45	55	63.4	SKC25	1.50
	BT40AD/B-SKA06-90	P2775765	1.8 - 6.0	90	20	19.5	31	SKC6	1.10
	BT40AD/B-SKA06-120	P2775766	1.8 - 6.0	120	20	19.5	31	SKC6	1.40
	BT40AD/B-SKA06-150	P2775767	1.8 - 6.0	150	20	19.5	31	SKC6	1.50
	BT40AD/B-SKA10-90	P2775768	1.75 - 10.0	90	28	27.5	35	SKC10	1.20
	BT40AD/B-SKA10-120	P2775769	1.75 - 10.0	120	28	27.5	35	SKC10	1.40
	BT40AD/B-SKA10-150	P2775770	1.75 - 10.0	150	28	27.5	35	SKC10	1.60
	BT40AD/B-SKA13-90	P2775771	2.75 - 13.0	90	33	33	43.6	SKC13	1.40
	BT40AD/B-SKA13-120	P2775772	2.75 - 13.0	120	33	33	43.6	SKC13	1.60
	BT40AD/B-SKA13-150	P2775773	2.75 - 13.0	150	33	33	43.6	SKC13	1.80
	BT40AD/B-SKA16-90	P2775774	2.75 - 16.0	90	40	40	52	SKC16	1.50
	BT40AD/B-SKA16-120	P2775775	2.75 - 16.0	120	40	40	52	SKC16	1.70
	BT40AD/B-SKA16-150	P2775776	2.75 - 16.0	150	40	40	52	SKC16	1.90
	BT40AD/B-SKA20-90	P2775777	3.5 - 20.0	90	48.5	48.5	59.6	SKC20	1.60
	BT40AD/B-SKA20-120	P2775778	3.5 - 20.0	120	48.5	48.5	59.6	SKC20	2.00
	BT40AD/B-SKA20-150	P2775779	3.5 - 20.0	150	48.5	48.5	59.6	SKC20	2.40
	BT40AD/B-SKA25-90	P2775780	16.0 - 25.4	90	55	55	63.4	SKC25	1.80
	BT40AD/B-SKA25-120	P2775781	16.0 - 25.4	120	55	55	63.4	SKC25	2.00
	BT40AD/B-SKA25-150	P2775782	16.0 - 25.4	150	55	55	63.4	SKC25	2.30



## ТОНКИЕ ЦАНГОВЫЕ ПАТРОНЫ SK

SKA

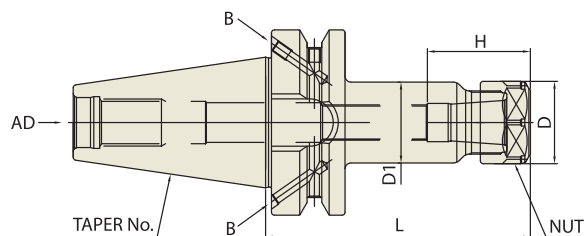

### JIS B6339/MAS 403-BT

JIS B6339 - BT	Taper Accuracy AT3	G Value 2.5	RPM 25,000	Coolant System AD/B
----------------	-----------------------	----------------	---------------	------------------------

Unit : mm

КОНУС No.	МОДЕЛЬ	АРТИКУЛ	ДИАП. ЗАЖИМА	L	D	D1	H	ЦАНГА	ВЕС (Kg)
50		P2775783	1.8 - 6.0	105	20	19.5	31	SKC6	3.80
	BT50AD/B-SKA06-135	P2775784	1.8 - 6.0	135	20	19.5	31	SKC6	3.90
	BT50AD/B-SKA06-165	P2775785	1.8 - 6.0	165	20	19.5	31	SKC6	4.00
	BT50AD/B-SKA06-195	P2775786	1.8 - 6.0	195	20	19.5	31	SKC6	4.20
	BT50AD/B-SKA10-105	P2775787	1.75 - 10.0	105	28	27.5	35	SKC10	4.20
	BT50AD/B-SKA10-135	P2775788	1.75 - 10.0	135	28	27.5	35	SKC10	4.40
	BT50AD/B-SKA10-165	P2775789	1.75 - 10.0	165	28	27.5	35	SKC10	4.60
	BT50AD/B-SKA10-195	P2775790	1.75 - 10.0	195	28	27.5	35	SKC10	4.80
	BT50AD/B-SKA13-105	P2775791	2.75 - 13.0	105	33	33	43.6	SKC13	4.50
	BT50AD/B-SKA13-135	P2775792	2.75 - 13.0	135	33	33	43.6	SKC13	4.70
	BT50AD/B-SKA13-165	P2775793	2.75 - 13.0	165	33	33	43.6	SKC13	4.90
	BT50AD/B-SKA13-195	P2775794	2.75 - 13.0	195	33	33	43.6	SKC13	5.20
	BT50AD/B-SKA16-105	P2775795	2.75 - 16.0	105	40	40	52	SKC16	4.70
	BT50AD/B-SKA16-135	P2775796	2.75 - 16.0	135	40	40	52	SKC16	4.90
	BT50AD/B-SKA16-165	P2775797	2.75 - 16.0	165	40	40	52	SKC16	5.10
	BT50AD/B-SKA16-195	P2775798	2.75 - 16.0	195	40	40	52	SKC16	5.50
	BT50AD/B-SKA20-105	P2775799	3.5 - 20.0	105	48.5	48.5	59.6	SKC20	4.30
	BT50AD/B-SKA20-135	P2775800	3.5 - 20.0	135	48.5	48.5	59.6	SKC20	4.60
	BT50AD/B-SKA20-165	P2775801	3.5 - 20.0	165	48.5	48.5	59.6	SKC20	5.00
	BT50AD/B-SKA20-195	P2775802	3.5 - 20.0	195	48.5	48.5	59.6	SKC20	5.40
BT50AD/B-SKA25-105	P2775803	16.0 - 25.4	105	55	55	63.4	SKC25	5.20	
BT50AD/B-SKA25-135	P2775804	16.0 - 25.4	135	55	55	63.4	SKC25	5.40	
BT50AD/B-SKA25-165	P2775805	16.0 - 25.4	165	55	55	63.4	SKC25	5.60	
BT50AD/B-SKA25-195	P2775806	16.0 - 25.4	195	55	55	63.4	SKC25	6.00	

# ТОНКИЕ ЦАНГОВЫЕ ПАТРОНЫ SK

## ТОНКИЕ ЦАНГОВЫЕ ПАТРОНЫ SK

SKA

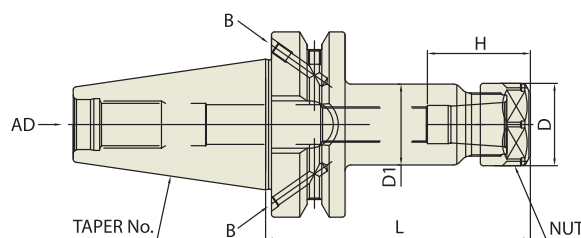

### ■ JIS B6339/MAS 403-BT

JIS B6339 - BT	Taper Accuracy AT3	G Value 6.3	RPM 15,000	Coolant System AD
-------------------	-----------------------	----------------	---------------	----------------------

Unit : mm

КОНУС No.	МОДЕЛЬ	АРТИКУЛ	ДИАП. ЗАЖИМА	L	D	D1	H	ЦАНГА	ВЕС (Kg)
30	BT30-SKA06-60	P2775807	1.8 - 6.0	60	20	19.5	31	SKC6	0.70
	BT30-SKA06-90	P2775808	1.8 - 6.0	90	20	19.5	31	SKC6	0.80
	BT30-SKA10-60	P2775809	1.75 - 10.0	60	28	27.5	35	SKC10	0.90
	BT30-SKA10-90	P2775810	1.75 - 10.0	90	28	27.5	35	SKC10	1.00
	BT30-SKA13-60	P2775811	2.75 - 13.0	60	33	33	43.6	SKC13	1.00
	BT30-SKA13-90	P2775812	2.75 - 13.0	90	33	33	43.6	SKC13	1.10
	BT30-SKA16-60	P2775813	2.75 - 16.0	60	40	40	52	SKC16	1.10
	BT30-SKA16-90	P2775814	2.75 - 16.0	90	40	40	52	SKC16	1.20
	BT30-SKA20-60	P2775815	3.5 - 20.0	60	48.5	40	59.6	SKC20	1.30
	BT30-SKA20-90	P2775816	3.5 - 20.0	90	48.5	40	59.6	SKC20	1.40
40	BT30-SKA25-90	P2775817	16.0 - 25.4	90	55	45	63.4	SKC25	1.50
	BT40-SKA06-90	P2775818	1.8 - 6.0	90	20	19.5	31	SKC6	1.10
	BT40-SKA06-120	P2775819	1.8 - 6.0	120	20	19.5	31	SKC6	1.40
	BT40-SKA06-150	P2775820	1.8 - 6.0	150	20	19.5	31	SKC6	1.50
	BT40-SKA10-90	P2775821	1.75 - 10.0	90	28	27.5	35	SKC10	1.20
	BT40-SKA10-120	P2775822	1.75 - 10.0	120	28	27.5	35	SKC10	1.40
	BT40-SKA10-150	P2775823	1.75 - 10.0	150	28	27.5	35	SKC10	1.60
	BT40-SKA13-90	P2775824	2.75 - 13.0	90	33	33	43.6	SKC13	1.40
	BT40-SKA13-120	P2775825	2.75 - 13.0	120	33	33	43.6	SKC13	1.60
	BT40-SKA13-150	P2775826	2.75 - 13.0	150	33	33	43.6	SKC13	1.80
	BT40-SKA16-90	P2775827	2.75 - 16.0	90	40	40	52	SKC16	1.50
	BT40-SKA16-120	P2775828	2.75 - 16.0	120	40	40	52	SKC16	1.70
	BT40-SKA16-150	P2775829	2.75 - 16.0	150	40	40	52	SKC16	1.90
	BT40-SKA20-90	P2775830	3.5 - 20.0	90	48.5	48.5	59.6	SKC20	1.60
	BT40-SKA20-120	P2775831	3.5 - 20.0	120	48.5	48.5	59.6	SKC20	2.00
BT40-SKA20-150	P2775832	3.5 - 20.0	150	48.5	48.5	59.6	SKC20	2.40	
BT40-SKA25-90	P2775833	16.0 - 25.4	90	55	55	63.4	SKC25	1.80	
BT40-SKA25-120	P2775834	16.0 - 25.4	120	55	55	63.4	SKC25	2.00	
BT40-SKA25-150	P2775835	16.0 - 25.4	150	55	55	63.4	SKC25	2.30	

## ТОНКИЕ ЦАНГОВЫЕ ПАТРОНЫ SK

SKA

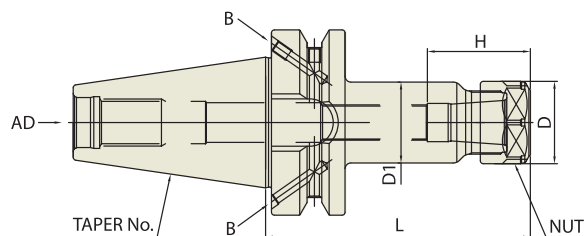

### JIS B6339/MAS 403-BT

<b>JIS B6339 - BT</b>	<b>Taper Accuracy</b> AT3	<b>G Value</b> 6.3	<b>RPM</b> 15,000	<b>Coolant System</b> AD
-----------------------	------------------------------	-----------------------	----------------------	-----------------------------

Unit : mm

КОНУС No.	МОДЕЛЬ	АРТИКУЛ	ДИАП. ЗАЖИМА	L	D	D1	H	ЦАНГА	ВЕС (Kg)
50	BT50-SKA06-105	P2775836	1.8 - 6.0	105	20	19.5	31	SKC6	3.80
	BT50-SKA06-135	P2775837	1.8 - 6.0	135	20	19.5	31	SKC6	3.90
	BT50-SKA06-165	P2775838	1.8 - 6.0	165	20	19.5	31	SKC6	4.00
	BT50-SKA06-195	P2775839	1.8 - 6.0	195	20	19.5	31	SKC6	4.20
	BT50-SKA10-105	P2775840	1.75 - 10.0	105	28	27.5	35	SKC10	4.20
	BT50-SKA10-135	P2775841	1.75 - 10.0	135	28	27.5	35	SKC10	4.40
	BT50-SKA10-165	P2775842	1.75 - 10.0	165	28	27.5	35	SKC10	4.60
	BT50-SKA10-195	P2775843	1.75 - 10.0	195	28	27.5	35	SKC10	4.80
	BT50-SKA13-105	P2775844	2.75 - 13.0	105	33	33	43.6	SKC13	4.50
	BT50-SKA13-135	P2775845	2.75 - 13.0	135	33	33	43.6	SKC13	4.70
	BT50-SKA13-165	P2775846	2.75 - 13.0	165	33	33	43.6	SKC13	4.90
	BT50-SKA13-195	P2775847	2.75 - 13.0	195	33	33	43.6	SKC13	5.20
	BT50-SKA16-105	P2775848	2.75 - 16.0	105	40	40	52	SKC16	4.70
	BT50-SKA16-135	P2775849	2.75 - 16.0	135	40	40	52	SKC16	4.90
	BT50-SKA16-165	P2775850	2.75 - 16.0	165	40	40	52	SKC16	5.10
	BT50-SKA16-195	P2775851	2.75 - 16.0	195	40	40	52	SKC16	5.50
	BT50-SKA20-105	P2775852	3.5 - 20.0	105	48.5	48.5	59.6	SKC20	4.30
	BT50-SKA20-135	P2775853	3.5 - 20.0	135	48.5	48.5	59.6	SKC20	4.60
	BT50-SKA20-165	P2775854	3.5 - 20.0	165	48.5	48.5	59.6	SKC20	5.00
	BT50-SKA20-195	P2775855	3.5 - 20.0	195	48.5	48.5	59.6	SKC20	5.40
BT50-SKA25-105	P2775856	16.0 - 25.4	105	55	55	63.4	SKC25	5.20	
BT50-SKA25-135	P2775857	16.0 - 25.4	135	55	55	63.4	SKC25	5.40	
BT50-SKA25-165	P2775858	16.0 - 25.4	165	55	55	63.4	SKC25	5.60	
BT50-SKA25-195	P2775859	16.0 - 25.4	195	55	55	63.4	SKC25	6.00	



# ТОНКИЕ ЦАНГОВЫЕ ПАТРОНЫ SK

## ТОНКИЕ ЦАНГОВЫЕ ПАТРОНЫ SK

SKA

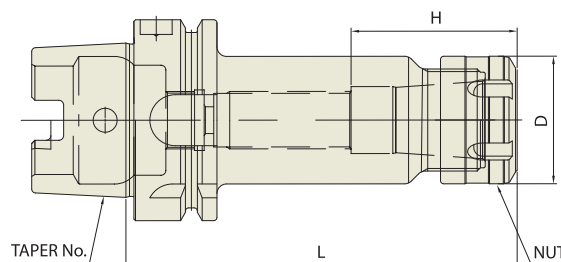

<b>DIN 69893 - HSK</b>	<b>Taper Accuracy</b> -	<b>G Value</b> 2.5	<b>RPM</b> 25,000	<b>Coolant System</b> AD
------------------------	----------------------------	-----------------------	----------------------	-----------------------------

### ■ DIN 69893/ISO 12164-1-HSK ФОРМА A

Unit: mm

КОНУС No.	МОДЕЛЬ	АРТИКУЛ	ДИАП. ЗАЖИМА	L	D	D1	H	ЦАНГА	ВЕС (Kg)
32A	HSK32A-SKA06-50	P2775860	1.8 - 6.0	50	20	19.5	31	SKC6	0.50
	HSK32A-SKA10-60	P2775861	1.75 - 10.0	60	28	26	35	SKC10	0.70
40A	HSK40A-SKA06-60	P2775862	1.8 - 6.0	60	20	19.5	31	SKC6	0.70
	HSK40A-SKA10-60	P2775863	1.75 - 10.0	60	28	27.5	35	SKC10	0.90
	HSK40A-SKA13-80	P2775864	2.75 - 13.0	80	33	33	43.6	SKC13	1.00
50A	HSK50A-SKA06-80	P2775865	1.8 - 6.0	80	20	19.5	31	SKC6	0.90
	HSK50A-SKA10-100	P2775866	1.75 - 10.0	100	28	27.5	35	SKC10	1.10
	HSK50A-SKA13-100	P2775867	2.75 - 13.0	100	33	33	43.6	SKC13	1.20
63A	HSK63A-SKA06-100	P2775868	1.8 - 6.0	100	20	19.5	31	SKC6	1.40
	HSK63A-SKA10-100	P2775869	1.75 - 10.0	100	28	27.5	35	SKC10	1.60
	HSK63A-SKA13-100	P2775870	2.75 - 13.0	100	33	33	43.6	SKC13	1.70
	HSK63A-SKA16-120	P2775871	2.75 - 16.0	120	40	40	52	SKC16	1.70
	HSK63A-SKA20-120	P2775872	3.5 - 20.0	120	48.5	48.5	59.6	SKC20	2.10
80A	HSK63A-SKA25-150	P2775873	16.0 - 25.4	150	55	55	63.4	SKC25	2.40
	HSK80A-SKA06-120	P2775874	1.8 - 6.0	120	20	19.5	31	SKC6	
	HSK80A-SKA10-120	P2775875	1.75 - 10.0	120	28	27.5	35	SKC10	
	HSK80A-SKA13-120	P2775876	2.75 - 13.0	120	33	33	43.6	SKC13	
	HSK80A-SKA16-120	P2775877	2.75 - 16.0	120	40	40	52	SKC16	
	HSK80A-SKA20-130	P2775878	3.5 - 20.0	130	48.5	48.5	59.6	SKC20	
100A	HSK80A-SKA25-150	P2775879	16.0 - 25.4	150	55	55	63.4	SKC25	
	HSK100A-SKA06-120	P2775880	1.8 - 6.0	120	20	19.5	31	SKC6	4.00
	HSK100A-SKA10-150	P2775881	1.75 - 10.0	150	28	27.5	35	SKC10	4.50
	HSK100A-SKA13-150	P2775882	2.75 - 13.0	150	33	33	43.6	SKC13	4.60
	HSK100A-SKA16-150	P2775883	2.75 - 16.0	150	40	40	52	SKC16	5.10
	HSK100A-SKA20-150	P2775884	3.5 - 20.0	150	48.5	48.5	59.6	SKC20	5.40
	HSK100A-SKA25-160	P2775885	16.0 - 25.4	160	55	55	63.4	SKC25	5.50

### ■ DIN 69893/ISO 12164-1-HSK ФОРМА E

Unit: mm

КОНУС No.	МОДЕЛЬ	АРТИКУЛ	ДИАП. ЗАЖИМА	L	D	D1	H	ЦАНГА	ВЕС (Kg)
25E	HSK25E-SKA06-45	P2775886	1.8 - 6.0	45	20	19.5	31	SKC6	
	HSK25E-SKA10-50	P2775887	1.75 - 10.0	50	28	21.5	35	SKC10	
32E	HSK32E-SKA06-50	P2775888	1.8 - 6.0	50	20	19.5	31	SKC6	0.50
	HSK32E-SKA10-60	P2775889	1.75 - 10.0	60	28	26	35	SKC10	0.70
40E	HSK40E-SKA06-60	P2775890	1.8 - 6.0	60	20	19.5	31	SKC6	0.70
	HSK40E-SKA10-60	P2775891	1.75 - 10.0	60	28	27.5	35	SKC10	0.90
	HSK40E-SKA13-80	P2775892	2.75 - 13.0	80	33	33	43.6	SKC13	1.00

## ТОНКИЕ ЦАНГОВЫЕ ПАТРОНЫ SK

SKA

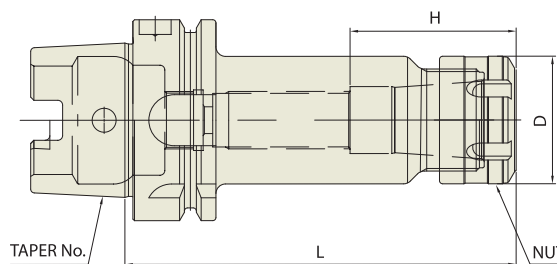

<b>DIN 69893 - HSK</b>	<b>Taper Accuracy</b> -	<b>G Value</b> 6.3	<b>RPM</b> 15,000	<b>Coolant System</b> AD
------------------------	----------------------------	-----------------------	----------------------	-----------------------------

### ■ DIN 69893/ISO 12164-1-HSK ФОРМА А

Unit : mm

КОНУС No.	МОДЕЛЬ	АРТИКУЛ	ДИАП. ЗАЖИМА	L	D	D1	H	ЦАНГА	ВЕС (Kg)
32A	HSK32A-SKA06-50	P2773502	1.8 - 6.0	50	20	19.5	31	SKC6	0.50
	HSK32A-SKA10-60	P2773503	1.75 - 10.0	60	28	26	35	SKC10	0.70
40A	HSK40A-SKA06-60	P2773504	1.8 - 6.0	60	20	19.5	31	SKC6	0.70
	HSK40A-SKA10-60	P2773505	1.75 - 10.0	60	28	27.5	35	SKC10	0.90
	HSK40A-SKA13-80	P2773506	2.75 - 13.0	80	33	33	43.6	SKC13	1.00
50A	HSK50A-SKA06-80	P2773507	1.8 - 6.0	80	20	19.5	31	SKC6	0.90
	HSK50A-SKA10-100	P2773508	1.75 - 10.0	100	28	27.5	35	SKC10	1.10
	HSK50A-SKA13-100	P2773509	2.75 - 13.0	100	33	33	43.6	SKC13	1.20
63A	HSK63A-SKA06-100	P2730492	1.8 - 6.0	100	20	19.5	31	SKC6	1.40
	HSK63A-SKA10-100	P2730494	1.75 - 10.0	100	28	27.5	35	SKC10	1.60
	HSK63A-SKA13-100	P2773510	2.75 - 13.0	100	33	33	43.6	SKC13	1.70
	HSK63A-SKA16-120	P2730510	2.75 - 16.0	120	40	40	52	SKC16	1.70
	HSK63A-SKA20-120	P2730515	3.5 - 20.0	120	48.5	48.5	59.6	SKC20	2.10
80A	HSK63A-SKA25-150	P2773501	16.0 - 25.4	150	55	55	63.4	SKC25	2.40
	HSK80A-SKA06-120	P2773511	1.8 - 6.0	120	20	19.5	31	SKC6	
	HSK80A-SKA10-120	P2773512	1.75 - 10.0	120	28	27.5	35	SKC10	
	HSK80A-SKA13-120	P2773513	2.75 - 13.0	120	33	33	43.6	SKC13	
	HSK80A-SKA16-120	P2773514	2.75 - 16.0	120	40	40	52	SKC16	
	HSK80A-SKA20-130	P2773515	3.5 - 20.0	130	48.5	48.5	59.6	SKC20	
100A	HSK80A-SKA25-150	P2773516	16.0 - 25.4	150	55	55	63.4	SKC25	
	HSK100A-SKA06-120	P2773517	1.8 - 6.0	120	20	19.5	31	SKC6	4.00
	HSK100A-SKA10-150	P2773518	1.75 - 10.0	150	28	27.5	35	SKC10	4.50
	HSK100A-SKA13-150	P2773519	2.75 - 13.0	150	33	33	43.6	SKC13	4.60
	HSK100A-SKA16-150	P2773520	2.75 - 16.0	150	40	40	52	SKC16	5.10
	HSK100A-SKA20-150	P2773521	3.5 - 20.0	150	48.5	48.5	59.6	SKC20	5.40
	HSK100A-SKA25-160	P2773522	16.0 - 25.4	160	55	55	63.4	SKC25	5.50

# ТОНКИЕ ЦАНГОВЫЕ ПАТРОНЫ SK

## ТОНКИЕ ЦАНГОВЫЕ ПАТРОНЫ SK

SKA

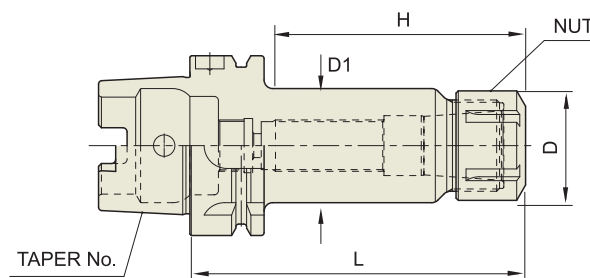

DIN 69893  
- HSK

Taper  
Accuracy  
-

G Value  
6.3

RPM  
15,000

Coolant  
System  
AD

### ■ DIN 69893/ISO 12164-1-HSK ФОРМА E

Unit : mm

КОНУС No.	МОДЕЛЬ	АРТИКУЛ	ДИАП. ЗАЖИМА	L	D	D1	H	ЦАНГА	ВЕС (Kg)
25E	HSK25E-SKA06-45	P2773523	1.8 - 6.0	45	20	19.5	31	SKC6	
	HSK25E-SKA10-50	P2773524	1.75 - 10.0	50	28	21.5	35	SKC10	
32E	HSK32E-SKA06-50	P2773525	1.8 - 6.0	50	20	19.5	31	SKC6	0.50
	HSK32E-SKA10-60	P2773526	1.75 - 10.0	60	28	26	35	SKC10	0.70
40E	HSK40E-SKA06-60	P2773527	1.8 - 6.0	60	20	19.5	31	SKC6	0.70
	HSK40E-SKA10-60	P2773528	1.75 - 10.0	60	28	27.5	35	SKC10	0.90
	HSK40E-SKA13-80	P2773529	2.75 - 13.0	80	33	33	43.6	SKC13	1.00

## ТОНКИЕ ЦАНГОВЫЕ ПАТРОНЫ SK **NEW**

SKA

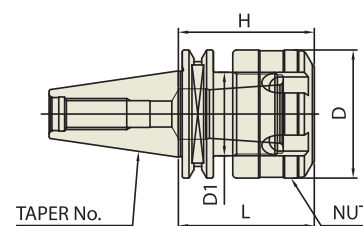

ISO 20/25

Taper  
Accuracy  
AT3

G Value  
2.5

RPM  
30,000

Coolant  
System  
AD

### ■ ISO 20/25

Unit : mm

КОНУС No.	МОДЕЛЬ	АРТИКУЛ	ДИАП. ЗАЖИМА	L	D	D1	H	ЦАНГА	ВЕС (Kg)
20	ISO20-SKA10-35	P2773530	1.75 - 10.0	35	33	21.5	35	SKC10	0.50
25	ISO25-SKA10-35	P2773531	1.75 - 10.0	35	33	21.5	35	SKC10	0.70

- ▶ По запросу доступны оправки с более высоким классом балансировки.
- ▶ Поставка в сборе со штрельным болтом.

## ТОНКИЕ ЦАНГОВЫЕ ПАТРОНЫ SK

SKA

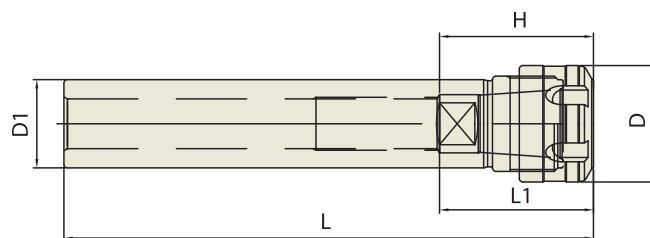

### ■ ЦИЛИНДРИЧЕСКИЕ-К

Unit : mm

КОНУС No.	МОДЕЛЬ	АРТИКУЛ	ДИАП. ЗАЖИМА	L	L1	D	D1	H	ЦАНГА	ВЕС (Kg)
20	K20-SKA06-100	P2773532	1.8 - 6.0	100	21 - 35	20	20	31	SKC6	0.20
	K20-SKA06-140	P2773533	1.8 - 6.0	140	21 - 35	20	20	31	SKC6	0.30
	K20-SKA10-100	P2773534	1.75 - 10.0	100	30 - 50	28	20	35	SKC10	0.20
	K20-SKA10-140	P2773535	1.75 - 10.0	140	30 - 50	28	20	35	SKC10	0.30
25	K25-SKA06-100	P2773536	1.8 - 6.0	100	21 - 35	20	25	31	SKC6	0.30
	K25-SKA06-140	P2773537	1.8 - 6.0	140	21 - 35	20	25	31	SKC6	0.50
	K25-SKA10-100	P2773538	1.75 - 10.0	100	30 - 50	28	25	35	SKC10	0.30
	K25-SKA10-150	P2773539	1.75 - 10.0	150	30 - 50	28	25	35	SKC10	0.50
	K25-SKA13-100	P2773540	2.75 - 13.0	100	31 - 65	33	25	43.6	SKC13	0.40
	K25-SKA13-150	P2773541	2.75 - 13.0	150	31 - 65	33	25	43.6	SKC13	0.60
32	K32-SKA10-100	P2773542	1.75 - 10.0	100	30 - 50	28	32	35	SKC10	0.50
	K32-SKA10-150	P2773543	1.75 - 10.0	150	30 - 50	28	32	35	SKC10	0.70
	K32-SKA13-100	P2773544	2.75 - 13.0	100	31 - 65	33	32	43.6	SKC13	1.00
	K32-SKA13-150	P2773545	2.75 - 13.0	150	31 - 65	33	32	43.6	SKC13	1.20
	K32-SKA16-100	P2773546	2.75 - 16.0	100	40 - 70	40	32	52	SKC16	1.00
	K32-SKA16-150	P2773547	2.75 - 16.0	150	40 - 70	40	32	52	SKC16	1.20
	K32-SKA20-100	P2773548	3.5 - 20.0	100	47 - 80	48.5	32	59.6	SKC20	1.10
	K32-SKA20-150	P2773549	3.5 - 20.0	150	47 - 80	48.5	32	59.6	SKC20	1.30

# ТОНКИЕ ЦАНГОВЫЕ ПАТРОНЫ SK

## ТОНКИЕ ЦАНГОВЫЕ ПАТРОНЫ SK

SKA

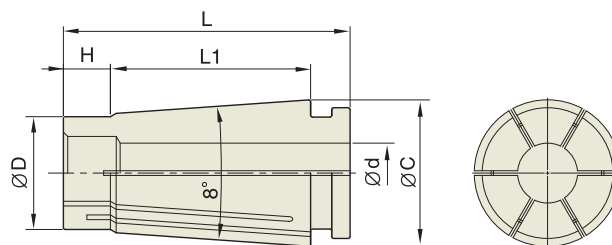

БИЕНИЕ: ≤0.005 мм на вылете 3D  
(По запросу доступна специальная цанга с биением 0.003 мм)

Unit: mm

ТИП	МОДЕЛЬ	Артикул	ДИАПАЗОН ЗАЖИМА	ТИП	МОДЕЛЬ	Артикул	ДИАПАЗОН ЗАЖИМА	ТИП	МОДЕЛЬ	Артикул	ДИАПАЗОН ЗАЖИМА
SKC6	SKC6-2	P2730780	1.8 - 2.0	SKC10	SKC10-2	P2730790	1.75 - 2.0	SKC13	SKC13-3	P2773656	2.75 - 3.0
	SKC6-2.5	P2773601	2.3 - 2.5		SKC10-2.5	P2773605	2.25 - 2.5		SKC13-3.5	P2773657	3.0 - 3.5
	SKC6-3	P2730782	2.8 - 3.0		SKC10-3	P2730791	2.75 - 3.0		SKC13-4	P2773658	3.5 - 4.0
	SKC6-3.5	P2773602	3.0 - 3.5		SKC10-3.5	P2773606	3.0 - 3.5		SKC13-4.5	P2773659	4.0 - 4.5
	SKC6-4	P2730784	3.5 - 4.0		SKC10-4	P2730792	3.5 - 4.0		SKC13-5	P2773660	4.5 - 5.0
	SKC6-4.5	P2773603	4.0 - 4.5		SKC10-4.5	P2773607	4.0 - 4.5		SKC13-5.5	P2773661	5.0 - 5.5
	SKC6-5	P2730786	4.5 - 5.0		SKC10-5	P2730793	4.5 - 5.0		SKC13-6	P2773662	5.5 - 6.0
	SKC6-5.5	P2773604	5.0 - 5.5		SKC10-5.5	P2773608	5.0 - 5.5		SKC13-6.5	P2773663	6.0 - 6.5
SKC6-6	P2730788	5.5 - 6.0	SKC10-6		P2730794	5.5 - 6.0	SKC13-7		P2773664	6.5 - 7.0	
			SKC10-6.5		P2773609	6.0 - 6.5	SKC13-7.5		P2773665	7.0 - 7.5	
			SKC10-7	P2730795	6.5 - 7.0	SKC13-8	P2773666		7.5 - 8.0		
			SKC10-7.5	P2773610	7.0 - 7.5	SKC13-8.5	P2773667		8.0 - 8.5		
			SKC10-8	P2730796	7.5 - 8.0	SKC13-9	P2773668		8.5 - 9.0		
			SKC10-8.5	P2773611	8.0 - 8.5	SKC13-9.5	P2773669	9.0 - 9.5			
			SKC10-9	P2730797	8.5 - 9.0	SKC13-10	P2773670	9.5 - 10.0			
			SKC10-9.5	P2773612	9.0 - 9.5	SKC13-10.5	P2773671	10.0 - 10.5			
			SKC10-10	P2730798	9.5 - 10.0	SKC13-11	P2773672	10.5 - 11.0			
						SKC13-11.5	P2773673	11.0 - 11.5			
						SKC13-12	P2773674	11.5 - 12.0			
						SKC13-12.5	P2773675	12.0 - 12.5			
						SKC13-13	P2773676	12.5 - 13.0			

### SKC РАЗМЕРЫ

Unit: mm

ТИП	D	L	L1	H	C	ВЕС (Kg)
SKC6	7.5	25.7	17.6	3.8	10	0.03
SKC10	12	32	21.3	5	15	0.04
SKC13	15.4	39	28.3	5.5	20	
SKC16	18.8	46	32	8	24	0.06
SKC20	22.5	54.2	41	8	29	
SKC25	28.9	58.2	43	8.5	35	0.10



## ТОНКИЕ ЦАНГОВЫЕ ПАТРОНЫ SK

SKA

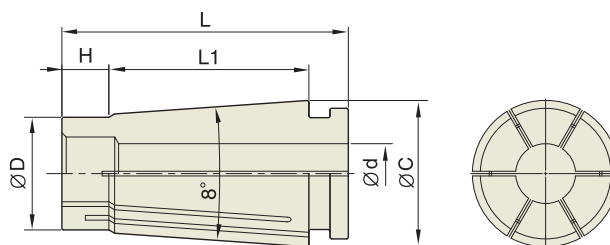

БИЕНИЕ: ≤0.005 мм на вылете 3D

(По запросу доступна специальная цанга с биением 0.003 мм)

Unit : mm

ТИП	МОДЕЛЬ	АРТИКУЛ	ДИАПАЗОН ЗАЖИМА	ТИП	МОДЕЛЬ	АРТИКУЛ	ДИАПАЗОН ЗАЖИМА	ТИП	МОДЕЛЬ	АРТИКУЛ	ДИАПАЗОН ЗАЖИМА
SKC16	SKC16-3	P2730810	2.75 - 3.0	SKC20	SKC20-4	P2730830	3.5 - 4.0	SKC25	SKC25-16.5	P2773677	16.0 - 16.5
	SKC16-3.5	P2773613	3.0 - 3.5		SKC20-4.5	P2773632	4.0 - 4.5		SKC25-17	P2773678	16.5 - 17.0
	SKC16-4	P2730812	3.5 - 4.0		SKC20-5	P2773633	4.5 - 5.0		SKC25-17.5	P2773679	17.0 - 17.5
	SKC16-4.5	P2773614	4.0 - 4.5		SKC20-5.5	P2773634	5.0 - 5.5		SKC25-18	P2773680	17.5 - 18.0
	SKC16-5	P2773615	4.5 - 5.0		SKC20-6	P2730832	5.5 - 6.0		SKC25-18.5	P2773681	18.0 - 18.5
	SKC16-5.5	P2773616	5.0 - 5.5		SKC20-6.5	P2773635	6.0 - 6.5		SKC25-19	P2773682	18.5 - 19.0
	SKC16-6	P2730814	5.5 - 6.0		SKC20-7	P2773636	6.5 - 7.0		SKC25-19.5	P2773683	19.0 - 19.5
	SKC16-6.5	P2773617	6.0 - 6.5		SKC20-7.5	P2773637	7.0 - 7.5		SKC25-20	P2773684	19.5 - 20.0
	SKC16-7	P2773618	6.5 - 7.0		SKC20-8	P2730834	7.5 - 8.0		SKC25-20.5	P2773685	20.0 - 20.5
	SKC16-7.5	P2773619	7.0 - 7.5		SKC20-8.5	P2773638	8.0 - 8.5		SKC25-21	P2773686	20.5 - 21.0
	SKC16-8	P2730816	7.5 - 8.0		SKC20-9	P2773639	8.5 - 9.0		SKC25-21.5	P2773687	21.0 - 21.5
	SKC16-8.5	P2773620	8.0 - 8.5		SKC20-9.5	P2773640	9.0 - 9.5		SKC25-22	P2773688	21.5 - 22.0
	SKC16-9	P2773621	8.5 - 9.0		SKC20-10	P2730836	9.5 - 10.0		SKC25-22.5	P2773689	22.0 - 22.5
	SKC16-9.5	P2773622	9.0 - 9.5		SKC20-10.5	P2773641	10.0 - 10.5		SKC25-23	P2773690	22.5 - 23.0
	SKC16-10	P2730818	9.5 - 10.0		SKC20-11	P2773642	10.5 - 11.0		SKC25-23.5	P2773691	23.0 - 23.5
	SKC16-10.5	P2773623	10.0 - 10.5		SKC20-11.5	P2773643	11.0 - 11.5		SKC25-24	P2773692	23.5 - 24.0
SKC16-11	P2773624	10.5 - 11.0	SKC20-12	P2730838	11.5 - 12.0	SKC25-24.5	P2773693	24.0 - 24.5			
SKC16-11.5	P2773625	10.0 - 11.5	SKC20-12.5	P2773644	12.0 - 12.5	SKC25-25	P2773694	24.5 - 25.0			
SKC16-12	P2730820	11.5 - 12.0	SKC20-13	P2773645	12.5 - 13.0	SKC25-25.4	P2773695	25.0 - 25.4			
SKC16-12.5	P2773626	12.0 - 12.5	SKC20-13.5	P2773646	13.0 - 13.5						
SKC16-13	P2773627	12.5 - 13.0	SKC20-14	P2730840	13.5 - 14.0						
SKC16-13.5	P2773628	13.0 - 13.5	SKC20-14.5	P2773647	14.0 - 14.5						
SKC16-14	P2773822	13.5 - 14.0	SKC20-15	P2773648	14.5 - 15.0						
SKC16-14.5	P2773629	14.0 - 14.5	SKC20-15.5	P2773649	15.0 - 15.5						
SKC16-15	P2773630	14.5 - 15.0	SKC20-16	P2730842	15.5 - 16.0						
SKC16-15.5	P2773631	15.0 - 15.5	SKC20-16.5	P2773650	16.0 - 16.5						
SKC16-16	P2730824	15.5 - 16.0	SKC20-17	P2773651	16.5 - 17.0						
			SKC20-17.5	P2773652	17.0 - 17.5						
			SKC20-18	P2730844	17.5 - 18.0						
			SKC20-18.5	P2773653	18.0 - 18.5						
			SKC20-19	P2773654	18.5 - 19.0						
			SKC20-19.5	P2773655	19.0 - 19.5						
			SKC20-20	P2730846	19.5 - 20.0						

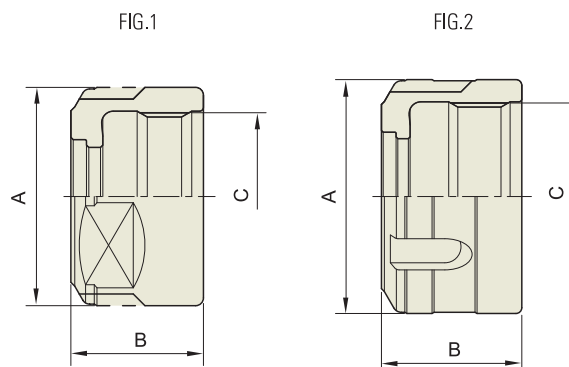

Unit : mm

ТИП	АРТИКУЛ	A	B	C	FIG.	БЕС (Kg)
SKN06	P2773581	20	15	M15.5X1.0	1	0.02
SKN10	P2773582	28	17	M21.5X1.0	1	0.04
SKN13	P2773583	33	21	M27X1.0	2	0.05
SKN16	P2773584	40	24	M32X1.5	2	0.06
SKN20	P2773585	48.5	24	M40X1.0	2	0.08
SKN25	P2773586	55	30	M42X1.5	2	0.10