

www.lukas-erzett.com







Products. Applications. 2018/2019









Always the Right Tool





Grinding, Polishing (bonded)

	Mounted Points	91
	Polishing tools	129
	Felt polishing points	140
	Abrasive and diamond pastes	144
	Tungsten carbide granulate-tipped tools	163



Grinding, Polishing (flexible)

	Lamellar Flap Discs	199
	Mounted flap wheels of abrasive cloth	235
	Flap wheels Flap rolls	259 269
	Abrasive Bands and Mandrels	277
	Abrasive Rolls and Mandrels	291
	Abrasive Caps and Abrasive Sleeves	297
	Abrasive Discs and Mandrels	309
	Fibre discs, backing plates, economy rolls, abrasive sheets and fl eece rolls	329



Precision Machining (CBN, diamond)

	CBN-/Diamond Grinding Tools, vitrified bonded	387
	CBN-/Diamond Mounted Points, electro-plated	393
	Diamond Files, electro-plated	397



Milling

	Tungsten-carbide burrs Burrs of HSS	17 65
	Filing Discs and Rings Tailor-made solutions	83
	Engraving cutters of solid carbide	87



Cutting, Grinding (conventional)

	Cutting discs	173
	Grinding discs	185

Cutting, Rough Grinding (diamond)

	Diamondtools	341
	Diamond Cup Wheels	350
	Diamond Dry Drill	351



Cleaning

	Technical Brushes	353
	AS-Cleaning fleece	365

Pneumatic Tools

	Air Tools	369
---	-----------	------------

Retail Trade, Accessories

	Product selection for retailers, accessories	399
	Index	431



1937

Foundation of Gebrüder Lukas Werkzeuge und Maschinen OHG

1941

Addition of grinding discs and mounted grinding points to production range

1975

Merger of Gebrüder Lukas Werkzeuge und Maschinen OHG and Rheinische Zahnbohrer und Kleinfräserfabrik Baumann & Co. to form today's company

1986

Start of cutting and grinding disc production

The -value proposition

“Always the Right Tool” As a family business we have honoured this proposition every day for more than 80 years now. Very early we responded to the requests for individual tailor-made solutions and thus set the standard for the market. Today we are the internationally recognized specialist for innovative solutions and the production of high-performance tools. With 650 employees, three state-of-the-art production sites, an enormous wealth of experience and a broad product portfolio LUKAS is well established in the market. Socially accepted, customer-focused, flexible and highly innovative.

2017

80 years "Always
the Right Tool"

2011

Acquisition of Schleifscheibenfabrik
Rottluff GmbH in Chemnitz

2010

Opening of the logistics
center in Engelskirchen

2004

Opening of the „TECHNIKUM“
training and demonstration center

1994

Completion of new company premises
in Skalna, Czech Republic

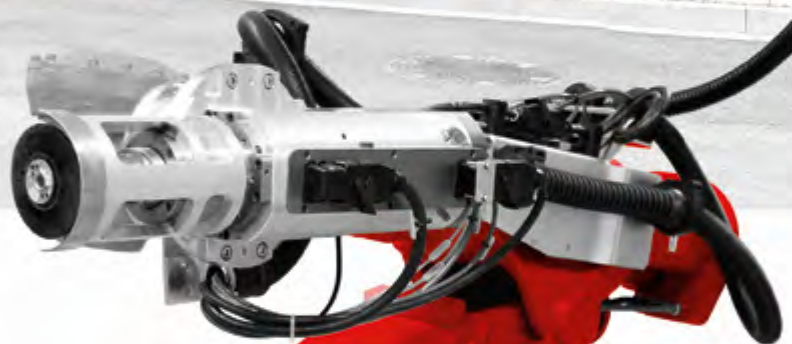



10.000

special solutions and various
innovations in use
throughout the world

250

days a year are dedicated
to passing on our
know-how

39

registered
patents



know-how

Visit our TECHNIKUM – where you can get hands-on with our expertise. Straight after the training class, you'll have a chance to put the theory into practice in our adjacent grinding centre. And if you have any specific application problems, our application and design engineers have an answer for (almost) every question.

And make the most of our "mobile TECHNIKUM", too. The LUKAS van contains everything you need for a professional tool seminar. Why not use the LUKAS van for a time-saving staff training session on your own premises?





LUKAS logistics

Fast, flexible and on time. Our smart logistics concept takes the hard work out of warehouse management for you. High delivery capability, an ultra-modern logistics centre and our speedy shipping agents ensure that the right tool is always there at the right time.





23

employees ensure
trouble-free shipping –
all over the world

4.500

products ready for shipment
within 48 hours

8.000

square-metre logistics area

30.000

customers worldwide

650

employees

service

We know what your working day consists of, and the challenges that go with it. Both our office staff and our external sales force are fully versed in both theory and practice, and are all happy to pick up an angle grinder themselves when the occasion calls for it. They speak your language, and can give you effective, tailored advice on choosing the right tool.

Your direct contact by E-Mail is:

@ first name.surname@lukas-erzett.de

LUKAS Sales team



Laura-Jane
Alberts



Julia Alef



Alexandre Altrock



Adam Angres



Sarah Geppert



Christoph
Hoffmann



Eva Jensch



Dorothea
Konopka



Markus Pollak



Nathalie
Poulalier-Thiel



Martin Reif



Mara Schmale



20

branches trust in our quality and experience



Nadine Behnke



Claudia Biesenbach



Andrea Bittner



Pawel Bojar



Frank Bosbach



Oliver Burghardt



Maria Cadelano



Finn Christiansen



Birgül Doganay



Katharina Kroner



Maria Lopez



Maria del Pilar Lozano



Susanne Marinas



Aline Matenia



Younes El Mejdafi



Nikolai Mollerer



Tomas Nienstedt



Christian Pallesche



Sonja Schmücker



Bernd Schorr



Lukas Schultz



Franziska Schwick



Ulrike Thomas



Elke Twardowski



We have 8 decades of
developing bespoke
tool solutions behind us



quality

We don't talk about quality, we let it speak for itself. Every day, and in everything we do. This practice makes LUKAS tools a safe, reliable factor in your manufacturing process and ensures the best possible production quality.

- Made in Germany
- Top quality raw materials
- State-of-the-art test facilities
- Quality management system according to DIN EN ISO 9001:2008
- Active membership of trade associations





Nine sections for
any application

The Catalogue

Navigate quickly and intuitively to the right tool for you. There are coloured dots above each product table to show the material group; you'll find the key at the bottom of each page. Next to them you'll find the product line indication – from one to three stars. Each table row contains recommendations for use; there's more information on these in the practical fold-out in the catalogue cover. New tools are shown on a darker grey background, for easy identification.

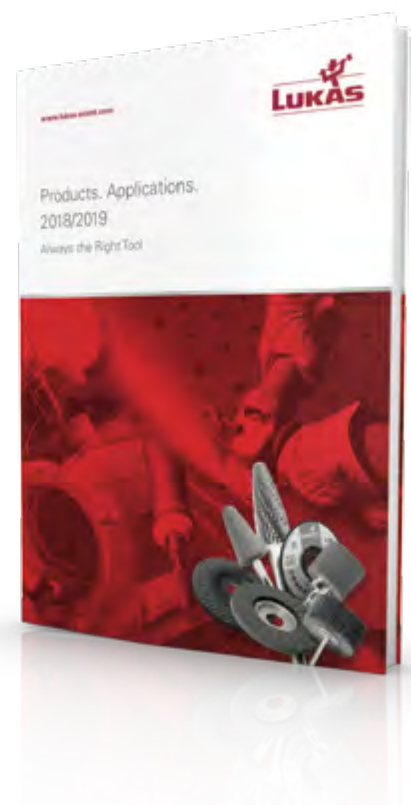



For all materials and for any application

The appropriate material groups for each tool are shown in the table header.

- **Inox/Steel**
- **Steel**
- **Aluminium**
- **Stone**
- **Cast material**
- **Plastic**
- **Titanium**

Product line

The product line is indicated with a simple star system:

- ★★★ High Performance
- ★★☆ Industry
- ★☆☆ Base

- 1 Application area
- 2 Product line
- 3 Product series
- 4 Usage power tool
- 5 New products
- 6 Application recommendation for the material group
- 7 Material key
- 8 Material classification and safety symbols

Tungsten Carbide Burrs

- 18 Technical Information

- 19 A summary of available shapes

- 20 Recommendations for use and cuts

- 22 Coatings

- 23 Tungsten-carbide burrs

Product line marking

The product lines are illustrated by star symbols at the top of the table; please refer to page **14** and **15**.

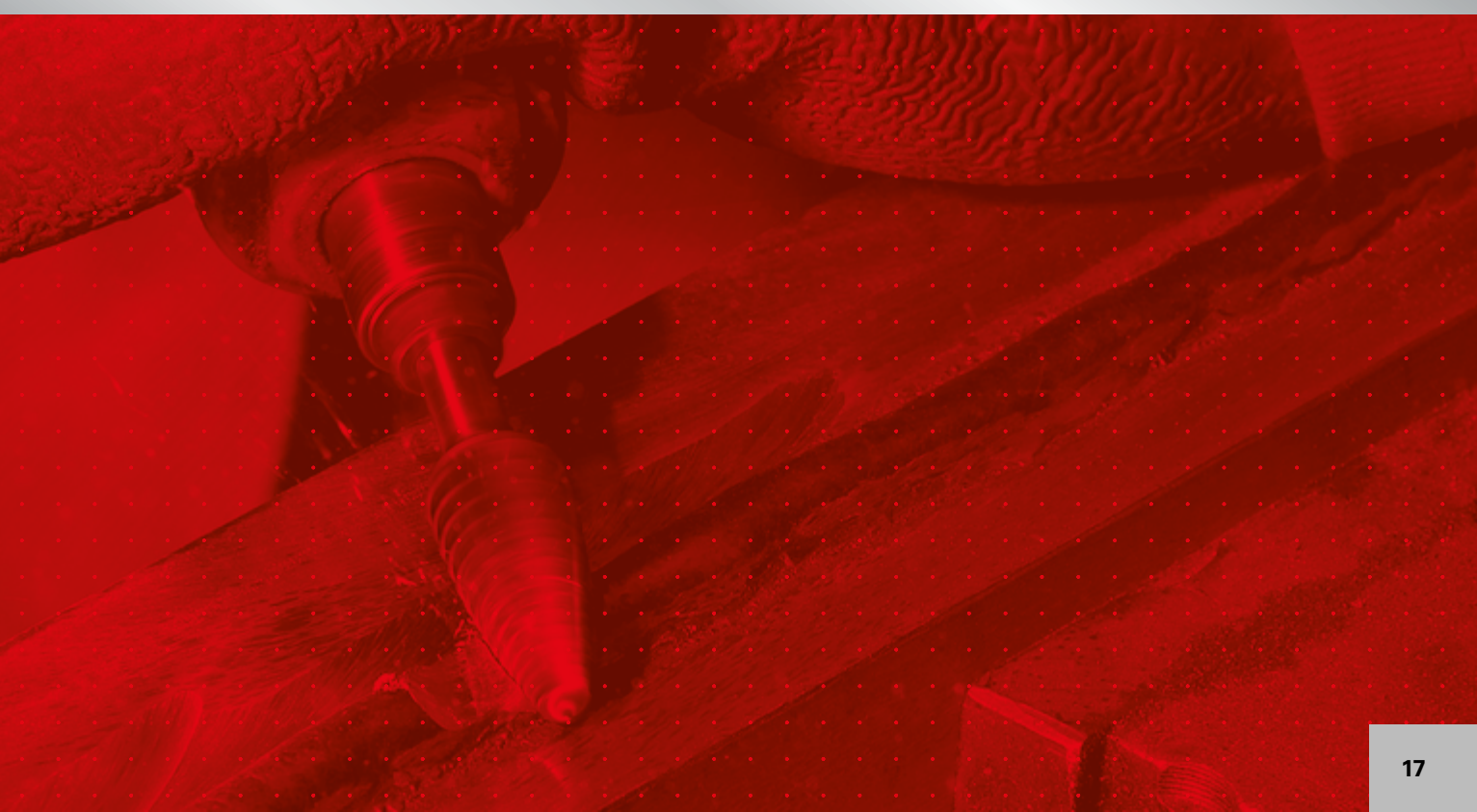

Technical Information



Quality

LUKAS carbide burrs are manufactured using high quality types of carbide and modern CNC automatic grinding machines in order to guarantee precision and repeatability of angle, profile and twist. Carbide burrs manufactured to your drawings or details assist in solving your particular stock removal problem.

Application

The best results are obtained by selecting the recommended cut and speed. Please refer to the cutting speeds in the table on page **21** or according to the table illustrating the various cuts on page **21**.

Power tools

Electric and pneumatic power tools are used; the bearings should be in good condition and the collets running true. Vibration and chatter will cause premature wear and tooth breakage. High pressure will reduce tool life and decreases tool efficiency.

Shanks

For safety reasons the largest possible shank diameter should always be selected from the table. Other shank diameters and lengths are available on request. A selection of burrs with extra long shanks appears on page **37** and **38**.

Robot application

LUKAS tungsten carbide burrs are precision tools, and have produced excellent results when used in conjunction with industrial robots. We can also develop the optimal burr for your particular application.

Coated

The reasons for producing cutting tools with hard coatings such as TiN, TiCN, TiALN and LTE are as follows:

- to increase tool life
- to reduce machining forces
- to improve chip removal

The increase in tool life is mainly the result of the considerably higher surface hardness of the coating in comparison to the base material of the tool itself. In addition, due to the high chemical stability, it minimizes the reaction between the cutting edge of the tool and the chip to be removed. The reduction of machining forces and the improvement in chip removal are achieved through a reduction in the friction between the free cutting zone of the tool and workpiece on the one hand, and the cutting edge of the tool and the chip removed on the other. The reduction in friction depends on the coating improving the surface finish and as previously described by largely avoiding any chemical reaction. Our technicians would be pleased to help you in the selection of the correct coating. Please note the different possibilities on page **22**.

Special tools

Tungsten carbide burrs manufactured to your design or drawing guarantee the LUKAS high quality standard, and can therefore assist in solving your particular machining problem.









Packaging

We use plastics-packaging; please select the respective packing unit from our product lists.



Recommendations for use

the cut to suit the material to be machined. Please kindly follow the principle: **The harder the material, the finer the cut!** The correct selection of speed is the basis of achieving optimum machining results and long tool-life; please refer to the adjoining table. On the following pages you will find some assistance to choose the right speed for your process. Use the highest possible speed within the indicated area. Too low a speed results in vibration, chipping and premature wear! Reduce the speed of the burrs only when using in large arc angles or when used on low heat conducting materials. Never let the shank and head become discoloured blue. For safety reasons, extended shanks should also be run at low speed. The power of your machine should be compatible with the machining process. A reduction in RPM due to lack of power – particularly common with pneumatic tools – should be avoided. Collets must run true. Run-out and vibration will result in chipping and premature wear. For the same reasons, take care that the machine bearings are in perfect condition. To avoid vibrations and shank breakage, select the shortest shank overhang as possible.

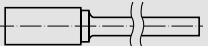
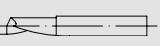
Materials and shapes
Tungsten-carbide burrs for the use on:

Application	Cut			Page
Stationary machines		Z7	TiAlN coating	23
Inox and Steel		Z42	Inox/Steel	24
Steel		Z7	Steel	25
Aluminium		Z9	Alu	27
Grey cast iron			Cast	28
Lightweight construction and plastic materials			Composite	30
Wood and pattern construction materials			Wood	32
Fine surfaces		ZF 1-3	Rotery files	33
Precision components		-	Miniature Burrs	34
Pattern construction materials		Z5	Small Burrs	35
difficult to access areas		-	extra-long shank	37
High-Speed-Cutting		-	Single cutting edge	39

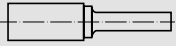
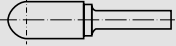
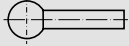
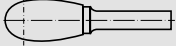
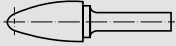
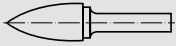
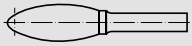
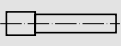
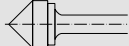
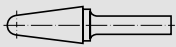
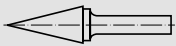
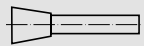
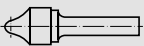
A summary of available shapes

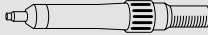
Shape		Shape		Page
Cylindrical		ZYA	7755/2	40
Cylindrical round nose		WRC	7755/3	43
Spherical		KUD	7755/4	46
Oval		TRE	7755/5	49
Arch round nose		RBF	7755/6	50
Arch pointed nose		SPG	7755/7	52
Flame		-	7755/8	54
Internal		-	-	54
Counter sink		KSJ	7755/9	55
Conical round nose		KEL	7755/10	55
Conical pointed nose		SKM	7755/11	57
Inverted cone		WKN	7755/12	58
Burrs for radius trimming (external)		-	-	59
Burrs for radius trimming (internal)		-	-	60
Tool-Set		-	-	61
Power Tools		-	-	369

Three steps to your optimum burr:



- 1 Select the **material** and **machining mode** (coarse to fine) from the table and
- 2 read off the recommended **cut** and **cutting speed**.
- 3 Determine the appropriate speed for your power tool in the second table.

Recommendations for use of tungsten carbide burrs

1			2		
Material	LUKAS material group (see also fold-out tab)	Strength [N/mm ²]	Machining	Cut	Recommended cutting speed v_c [m/min]
Steel, cast steel	1 Steel and cast steel	< 800	coarse	Z3, Z7 Steel, ZX	500–700
			medium	Z5, Z42 Inox/Steel	300–500
			fine	ZF3	500–700
	2 Alloyed / hardened & tempered steels	800 to 1200	coarse	Z7 Steel, ZX	400–600
			medium	Z5	300–400
			fine	ZF3	400–600
	3 Tool Steels	> 1200	coarse	Z7 Steel, Z4	300–500
			medium	Z5	300–400
			fine	ZF3	400–600
Stainless steel	4 Rust / acid / heat-resistant steel and cast steel	to 800	coarse	Z2, Z6	400–500
			medium	Z3, Z7 Steel, Z4, Z5, Z42 Inox/Steel	300–500
			fine	ZF3	400–600
Cast metal	5 Cast iron	150 to 300	coarse	Cast, Z6	400–600
			medium	Z7 Steel	300–500
		300 to 450	coarse	Cast, Z7 Steel	300–500
			medium	Z5	300–500
			fine	ZF3	400–700
			coarse	Z9 Alu	600–1000
Non-ferrous metal 1	6 Aluminium, magnesium and copper alloys	to 450	medium	Z1	500–900
			coarse	Z9 Alu, Z1	400–800
	Brass, bronze, titanium	to 450	medium	Z2	400–600
			fine	ZF3	500–600
		up to 450	coarse	Z6	300–500
			medium	Z7 Steel	300–400
Non-ferrous metal 2	7 Titanium and nickel alloys	to 900	fine	ZF3	500–700
			coarse	Z4	300–400
			medium	Z5	400–500
		900 to 1500	fine	ZF3	400–600
			coarse	Composite, Z1, Z9 Alu	600–1000
			fine	Composite, Wood	500–900
Plastics and wood	8 Plastic / wood / rubber	20 to 400	coarse	Composite, Z1	500–800
			fine	Composite, Z2, Wood	400–800
		400 to 1000	coarse	Composite, Z1	500–800
			fine	Composite, Z2, Wood	400–800

Tip: Page 19 contains a complete overview of the shapes for your chosen milling tool.

Machining



coarse

medium

fine

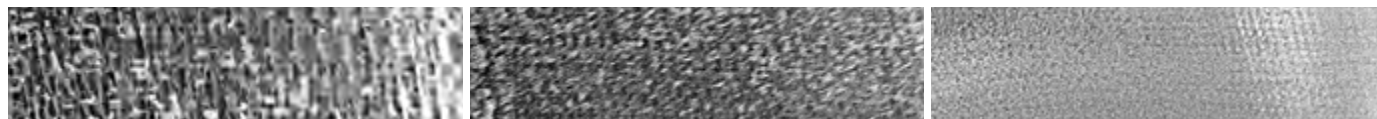

Rotational speeds for milling tools

based on the tool diameter and cutting speed



3									
Recommended cutting speed v_c [m/min]									
		300	400	500	600	700	800	900	1000
Rotational speed [min-1]									
Tool diameter [mm]	2	48.000	64.000	80.000	95.000	111.000	127.000	143.000	159.000
	3	32.000	42.000	53.000	64.000	74.000	85.000	95.000	106.000
	4	24.000	32.000	40.000	48.000	56.000	64.000	72.000	80.000
	6	16.000	21.000	27.000	32.000	37.000	42.000	48.000	53.000
	8	12.000	16.000	20.000	24.000	28.000	32.000	36.000	40.000
	10	10.000	13.000	16.000	19.000	22.000	25.000	29.000	32.000
	12	8.000	11.000	13.000	16.000	19.000	21.000	24.000	27.000
	16	6.000	8.000	10.000	12.000	14.000	16.000	18.000	20.000
20	5.000	6.000	8.000	10.000	11.000	13.000	14.000	16.000	

Cuts

	Z 9 Alu	Very coarse single cut with faceting for soft materials		Z 42 Inox/ Steel	Robust faceted toothing for steel and stainless steel
	Z 1	Coarse cut for soft materials		Z 4	Fine cross cut for hard materials
	Z 2	Robust single cut for high stock removal		Z 6	Fine cross cut for hard materials
	Z 3	Medium single cut		Z 7 Steel	Medium cross cut
	Z 5	Very fine single cut for high-quality surface		Cast	Fine cross cut especially to machine the inside of the bore (page 38)
	Z F	Very fine cross cut (page 51)		Com- posite	Cross cut for machining plastic (page 44)
	Wood	Rasp cut for pattern construction (page 50)		Z X	Universal cross cut for practically every application

Coatings



Coatings	Specification (LUKAS)	Properties	Friction on steel (dry)
	TiN (Titanium nitride)	general purpose coating for steel and cast iron, high toughness	0,65–0,70 µm
	TiCN (Titanium carbon nitride)	wear resisting coating for fine deburring process. Suited to applications with higher thermal and shock loads.	0,10–0,20 µm
	TiAlN (Titanium aluminium nitride (see page 23)	high performance coating with a high degree of hardness and low heat conductivity; therefore suitable for high thermal and mechanical applications	0,30–0,35 µm
	LTE (hard coating carbon-based)	Special coating with lotus-effect for long chip and smearing non-ferrous metals, particularly aluminium alloys. Excellent sliding friction properties reducing loading on cutting edges.	0,10–0,20 µm

The reasons for producing cutting tools with hard coatings are as follows:

- to increase tool life
- to reduce machining forces
- to improve chip removal

Tungsten-carbide burrs with TiAlN-coating*

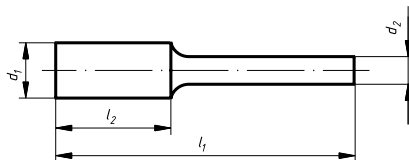
★★★

Ordering example: A10010616608TIAL1

Further dimensions, cuts and shank lengths on request.

PG 1

Product number	Description	Shape	Cut	d ₁ mm	l ₂ mm	d ₂ mm	l ₁ mm	recommended for	Information on page 438		
A10010616608TIALN	HFA 0616.06		Z7 Steel	6	16	6	50	1 2 3 5 7		■	1
A10010820608TIALN	HFA 0820.06		Z7 Steel	8	20	6	60	1 2 3 5 7		■	1
A10011020608TIALN	HFA 1020.06		Z7 Steel	10	20	6	60	1 2 3 5 7		■	1
A10010616608TIAL1	HFAS 0616.06		Z7 Steel	6	16	6	50	1 2 3 5 7		■	1
A10010820608TIAL1	HFAS 0820.06		Z7 Steel	8	20	6	60	1 2 3 5 7		■	1
A10011020608TIAL1	HFAS 1020.06		Z7 Steel	10	20	6	60	1 2 3 5 7		■	1
A10011225608TIAL1	HFAS 1225.06		Z7 Steel	12	25	6	65	1 2 3 5 7		■	1
A10020616608TIALN	HFC 0616.06		Z7 Steel	6	16	6	50	1 2 3 5 7		■	1
A10020820608TIALN	HFC 0820.06		Z7 Steel	8	20	6	60	1 2 3 5 7		■	1
A10021020608TIALN	HFC 1020.06		Z7 Steel	10	20	6	60	1 2 3 5 7		■	1
A10021225608TIALN	HFC 1225.06		Z7 Steel	12	25	6	65	1 2 3 5 7		■	1
A10030606608TIALN	HFD 0605.06			Z7 Steel	6	5	6	50	1 2 3 5 7		■
A10030808608TIALN	HFD 0807.06	Z7 Steel		8	7	6	47	1 2 3 5 7		■	1
A10031010608TIALN	HFD 1009.06	Z7 Steel		10	9	6	49	1 2 3 5 7		■	1
A10031210608TIALN	HFD 1210.06	Z7 Steel		12	10	6	50	1 2 3 5 7		■	1
A10031614608TIALN	HFD 1614.06	Z7 Steel		16	14	6	54	1 2 3 5 7		■	1
A10100618608TIALN	HFF 0618.06			Z7 Steel	6	18	6	50	1 2 3 5 7		■
A10101225608TIALN	HFF 1225.06		Z7 Steel	12	25	6	65	1 2 3 5 7		■	1
A10101630608TIALN	HFF 1630.06		Z7 Steel	16	30	6	70	1 2 3 5 7		■	1
A10040618608TIALN	HFG 0618.06		Z7 Steel	6	18	6	50	1 2 3 5 7		■	1
A10041020608TIALN	HFG 1020.06		Z7 Steel	10	20	6	60	1 2 3 5 7		■	1
A10041225608TIALN	HFG 1225.06		Z7 Steel	12	25	6	65	1 2 3 5 7		■	1
A10041630608TIALN	HFG 1630.06		Z7 Steel	16	30	6	70	1 2 3 5 7		■	1
A10090820608TIALN	HFH 0820.06		Z7 Steel	8	20	6	60	1 2 3 5 7		■	1
A10091230608TIALN	HFH 1230.06		Z7 Steel	12	30	6	70	1 2 3 5 7		■	1
A10071020608TIALN	HFL 1020.06		Z7 Steel	10	20	6	60	1 2 3 5 7		■	1
A10071230608TIALN	HFL 1230.06		Z7 Steel	12	30	6	70	1 2 3 5 7		■	1
A10051020608TIALN	HFM 1020.06			Z7 Steel	10	20	6	60	1 2 3 5 7		■

*High performance coating with a high degree of hardness and low heat conductivity; therefore suitable for high thermal and mechanical applications; very low friction value.

The reasons for producing Tungsten-carbide burrs with AlN-coating are as follows:

- to increase tool life
- to reduce machining forces
- to improve chip removal

Tungsten-carbide burrs, Z42 Inox/Steel

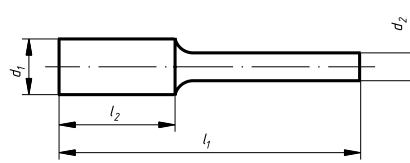

Ordering example: A10010616620

Further dimensions, cuts and shank lengths on request

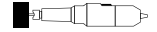

Product number	Description	Shape	Cut	similar to DIN 8033	d ₁ mm	l ₂ mm	d ₂ mm	l ₁ mm	recommended for	PG 1	
										Information on page 438	
A10010616620	HFA 0616.06		Z42 Inox/Steel	ZYA 0616	6	16	6	50	① ② ③ ④	■	1
A10010820620	HFA 0820.06		Z42 Inox/Steel	ZYA 0820	8	20	6	60	① ② ③ ④	■	1
A10011020620	HFA 1020.06		Z42 Inox/Steel	ZYA 1020	10	20	6	60	① ② ③ ④	■	1
A10011225620	HFA 1225.06		Z42 Inox/Steel	ZYA 1225	12	25	6	65	① ② ③ ④	■	1
A10020616620	HFC 0616.06		Z42 Inox/Steel	WRC 0616	6	16	6	50	① ② ③ ④	■	1
A10020820620	HFC 0820.06		Z42 Inox/Steel	WRC 0820	8	20	6	60	① ② ③ ④	■	1
A10021020620	HFC 1020.06		Z42 Inox/Steel	WRC 1020	10	20	6	60	① ② ③ ④	■	1
A10021225620	HFC 1225.06		Z42 Inox/Steel	WRC 1225	12	25	6	65	① ② ③ ④	■	1
A10030605620	HFD 0605.06		Z42 Inox/Steel	KUD 0605	6	5	6	50	① ② ③ ④	■	1
A10030807620	HFD 0807.06		Z42 Inox/Steel	KUD 0807	8	7	6	47	① ② ③ ④	■	1
A10031009620	HFD 1009.06		Z42 Inox/Steel	KUD 1009	10	9	6	49	① ② ③ ④	■	1
A10031210620	HFD 1210.06		Z42 Inox/Steel	KUD 1210	12	10	6	51	① ② ③ ④	■	1
A10100618620	HFF 0618.06		Z42 Inox/Steel	RBF 0618	6	18	6	50	① ② ③ ④	■	1
A10100820620	HFF 0820.06		Z42 Inox/Steel	—	8	20	6	60	① ② ③ ④	■	1
A10101020620	HFF 1020.06		Z42 Inox/Steel	RBF 1020	10	20	6	60	① ② ③ ④	■	1
A10101225620	HFF 1225.06		Z42 Inox/Steel	RBF 1225	12	25	6	65	① ② ③ ④	■	1
A10040618620	HFG 0618.06		Z42 Inox/Steel	SPG 0618	6	18	6	50	① ② ③ ④	■	1
A10040820620	HFG 0820.06		Z42 Inox/Steel	—	8	20	6	60	① ② ③ ④	■	1
A10041020620	HFG 1020.06		Z42 Inox/Steel	SPG 1020	10	20	6	60	① ② ③ ④	■	1
A10041225620	HFG 1225.06		Z42 Inox/Steel	SPG 1225	12	25	6	65	① ② ③ ④	■	1
A10050618620	HFM 0618.06		Z42 Inox/Steel	SKM 0618	6	18	6	50	① ② ③ ④	■	1
A10050820620	HFM 0820.06		Z42 Inox/Steel	—	8	20	6	60	① ② ③ ④	■	1
A10051020620	HFM 1020.06		Z42 Inox/Steel	SKM 1020	10	20	6	60	① ② ③ ④	■	1
A10051225620	HFM 1225.06		Z42 Inox/Steel	SKM 1225	12	25	6	65	① ② ③ ④	■	1

- The new Z42 inox/steel tungsten carbide burr quickly and reliably removes the two important materials, stainless steel and steel.
- The robust tooth geometry with facet profile prevents eruptions and guarantees high material removal rates in the long run. This saves you time and setup costs.
- Thanks to the optimised chip breaker, you can now cut even more ergonomically, at the same time achieving a better finish than before.
- You can now reduce your expenditure for stockkeeping and logistics. Prevent incorrect use through unequivocal tool marking and the use of only few variants.

Tungsten-carbide burrs Steel

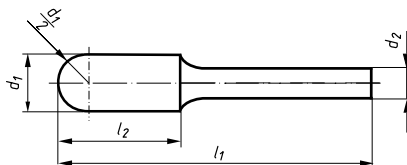

Ordering example: A10010616608

Further dimensions, cuts and shank lengths on request



PG 1

Product number	Description	Shape	Cut	similar to DIN 8033	d ₁ mm	l ₂ mm	d ₂ mm	l ₁ mm	recommended for			
Information on page 438												
A10010616608	HFA 0616.06		Z7 Steel	ZYA 0616	6	16	6	50	1 2 3 5 7		■	1
A10010820608	HFA 0820.06		Z7 Steel	ZYA 0820	8	20	6	60	1 2 3 5 7		■	1
A10011013608	HFA 1013.06		Z7 Steel	ZYA 1013	10	13	6	53	1 2 3 5 7		■	1
A10011020608	HFA 1020.06		Z7 Steel	ZYA 1020	10	20	6	60	1 2 3 5 7		■	1
A10011025608	HFA 1025.06		Z7 Steel	ZYA 1025	10	25	6	65	1 2 3 5 7		■	1
A10011225608	HFA 1225.06		Z7 Steel	ZYA 1225	12	25	6	65	1 2 3 5 7		■	1
A10011625608	HFA 1625.06		Z7 Steel	ZYA 1625	16	25	6	65	1 2 3 5 7		■	1
A10020616608	HFC 0616.06		Z7 Steel	WRC 0616	6	16	6	50	1 2 3 5 7		■	1
A10020820608	HFC 0820.06		Z7 Steel	WRC 0820	8	20	6	60	1 2 3 5 7		■	1
A10021020608	HFC 1020.06		Z7 Steel	WRC 1020	10	20	6	60	1 2 3 5 7		■	1
A10021020808	HFC 1020.08		Z7 Steel	WRC 1020	10	20	8	60	1 2 3 5 7		■	1
A10021025608	HFC 1025.06		Z7 Steel	WRC 1025	10	25	6	65	1 2 3 5 7		■	1
A10021225608	HFC 1225.06		Z7 Steel	WRC 1225	12	25	6	65	1 2 3 5 7		■	1
A10021225808	HFC 1225.08		Z7 Steel	WRC 1225	12	25	8	65	1 2 3 5 7		■	1
A10021625608	HFC 1625.06	Z7 Steel	WRC 1625	16	25	6	65	1 2 3 5 7		■	1	
A10030606608	HFD 0605.06		Z7 Steel	KUD 0605	6	5	6	50	1 2 3 5 7		■	1
A10030808608	HFD 0807.06		Z7 Steel	KUD 0807	8	7	6	47	1 2 3 5 7		■	1
A10031010608	HFD 1009.06		Z7 Steel	KUD 1009	10	9	6	49	1 2 3 5 7		■	1
A10031212608	HFD 1210.06		Z7 Steel	KUD 1210	12	10	6	51	1 2 3 5 7		■	1
A10031210808	HFD 1210.08		Z7 Steel	KUD 1210	12	10	8	51	1 2 3 5 7		■	1
A10031616608	HFD 1614.06		Z7 Steel	KUD 1614	16	14	6	54	1 2 3 5 7		■	1
A10032020608	HFD 2018.06		Z7 Steel	KUD 2018	20	18	6	58	1 2 3 5 7		■	1
A10060610608	HFE 0610.06		Z7 Steel	TRE 0610	6	10	6	50	1 2 3 5 7		■	1
A10060813608	HFE 0813.06		Z7 Steel	TRE 0813	8	13	6	53	1 2 3 5 7		■	1
A10061220608	HFE 1220.06		Z7 Steel	TRE 1220	12	20	6	60	1 2 3 5 7		■	1
A10061625608	HFE 1625.06		Z7 Steel	TRE 1625	16	25	6	65	1 2 3 5 7		■	1
A10100618608	HFF 0618.06		Z7 Steel	RBF 0618	6	18	6	50	1 2 3 5 7		■	1
A10100820608	HFF 0820.06		Z7 Steel	---	8	20	6	60	1 2 3 5 7		■	1
A10101020608	HFF 1020.06		Z7 Steel	RBF 1020	10	20	6	60	1 2 3 5 7		■	1
A10101225608	HFF 1225.06		Z7 Steel	RBF 1225	12	25	6	65	1 2 3 5 7		■	1
A10101225808	HFF 1225.08		Z7 Steel	RBF 1225	12	25	8	65	1 2 3 5 7		■	1
A10101230608	HFF 1230.06		Z7 Steel	RBF 1230	12	30	6	70	1 2 3 5 7		■	1
A10101630608	HFF 1630.06		Z7 Steel	RBF 1630	16	30	6	70	1 2 3 5 7		■	1
A10040618608	HFG 0618.06		Z7 Steel	SPG 0618	6	18	6	50	1 2 3 5 7		■	1
A10040820608	HFG 0820.06		Z7 Steel	---	8	20	6	60	1 2 3 5 7		■	1
A10041020608	HFG 1020.06		Z7 Steel	SPG 1020	10	20	6	60	1 2 3 5 7		■	1

Tungsten-carbide burrs Steel

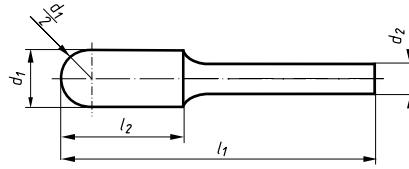

Ordering example: A10010616608

Further dimensions, cuts and shank lengths on request

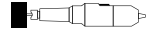

PG 1

Product number	Description	Shape	Cut	similar to DIN 8033	d ₁ mm	l ₂ mm	d ₂ mm	l ₁ mm	recommended for Information on page 438						
A10041220608	HFG 1220.06		Z7 Steel	SPG 1220	12	20	6	60	1	2	3	5	7	■	1
A10041225608	HFG 1225.06		Z7 Steel	SPG 1225	12	25	6	65	1	2	3	5	7	■	1
A10041230608	HFG 1230.06		Z7 Steel	SPG 1230	12	30	6	70	1	2	3	5	7	■	1
A10041630608	HFG 1630.06		Z7 Steel	SPG 1630	16	30	6	70	1	2	3	5	7	■	1
A10090820608	HFH 0820.06		Z7 Steel		8	20	6	60	1	2	3	5	7	■	1
A10091230608	HFH 1230.06		Z7 Steel		12	30	6	70	1	2	3	5	7	■	1
A10091635608	HFH 1635.06		Z7 Steel		16	35	6	75	1	2	3	5	7	■	1
A10070820608	HFL 0820.06		Z7 Steel	---	8	20	6	60	1	2	3	5	7	■	1
A10071020608	HFL 1020.06		Z7 Steel	KEL 1020	10	20	6	60	1	2	3	5	7	■	1
A10071225608	HFL 1225.06		Z7 Steel	KEL 1225	12	25	6	65	1	2	3	5	7	■	1
A10071230608	HFL 1230.06		Z7 Steel	KEL 1230	12	30	6	70	1	2	3	5	7	■	1
A10071630608	HFL 1630.06	Z7 Steel	KEL 1630	16	30	6	70	1	2	3	5	7	■	1	
A10050618608	HFM 0618.06		Z7 Steel	SKM 0618	6	18	6	50	1	2	3	5	7	■	1
A10050820608	HFM 0820.06		Z7 Steel	---	8	20	6	60	1	2	3	5	7	■	1
A10051020608	HFM 1020.06		Z7 Steel	SKM 1020	10	20	6	60	1	2	3	5	7	■	1
A10051225608	HFM 1225.06		Z7 Steel	SKM 1225	12	25	6	65	1	2	3	5	7	■	1

Further shapes and dimensions in the tables from page 40.

Burrs for machining non-ferrous metals, Z9 Alu

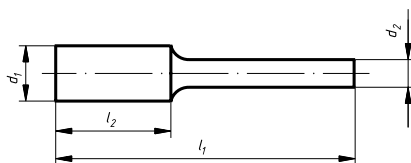

Ordering example: A10010313309

Further dimensions, cuts and shank lengths on request



PG 1

Product number	Description	Shape	Cut	similar to DIN 8033	d ₁ mm	l ₂ mm	d ₂ mm	l ₁ mm	recommended for					
Information on page 438														
A10010313309	HFA 0313.03		Z9 Alu	ZYA 0313	3	13	3	40			6	8	■	1
A10010616609	HFA 0616.06		Z9 Alu	ZYA 0616	6	16	6	50			6	8	■	1
A10011225609	HFA 1225.06		Z9 Alu	ZYA 1225	12	25	6	65			6	8	■	1
A10011225809	HFA 1225.08		Z9 Alu	ZYA 1225	12	25	8	65			6	8	■	1
A10011625609	HFA 1625.06		Z9 Alu	ZYA 1625	16	25	6	65			6	8	■	1
A10011625809	HFA 1625.08		Z9 Alu	ZYA 1625	16	25	8	65			6	8	■	1
A10020313309	HFC 0313.03		Z9 Alu	WRC 0313	3	13	3	40			6	8	■	1
A10020616609	HFC 0616.06		Z9 Alu	WRC 0616	6	16	6	50			6	8	■	1
A10020820609	HFC 0820.06		Z9 Alu	WRC 0820	8	20	6	60			6	8	■	1
A10021225609	HFC 1225.06		Z9 Alu	WRC 1225	12	25	6	65			6	8	■	1
A10021225809	HFC 1225.08		Z9 Alu	WRC 1225	12	25	8	65			6	8	■	1
A10021625609	HFC 1625.06		Z9 Alu	WRC 1625	16	25	6	65			6	8	■	1
A10030403309	HFD 0403.03		Z9 Alu	KUD 0403	4	3	3	34			6	8	■	1
A10030605609	HFD 0605.06		Z9 Alu	KUD 0605	6	5	6	50			6	8	■	1
A10031212609	HFD 1210.06		Z9 Alu	KUD 1210	12	10	6	50			6	8	■	1
A10031616609	HFD 1614.06		Z9 Alu	KUD 1614	16	14	6	54			6	8	■	1
A10031616809	HFD 1614.08		Z9 Alu	KUD 1614	16	14	8	54			6	8	■	1
A10061225809	HFE 1225.08		Z9 Alu	TRE 1225	12	25	8	65			6	8	■	1
A10061625809	HFE 1625.08		Z9 Alu	TRE 1625	16	25	8	65			6	8	■	1
A10100313309	HFF 0313.03		Z9 Alu	RBFB 0313	3	13	3	40			6	8	■	1
A10100618609	HFF 0618.06		Z9 Alu	RBFB 0618	6	18	6	50			6	8	■	1
A10101225609	HFF 1225.06		Z9 Alu	RBFB 1225	12	25	6	65			6	8	■	1
A10101225809	HFF 1225.08		Z9 Alu	RBFB 1225	12	25	8	65			6	8	■	1
A10101630609	HFF 1630.06		Z9 Alu	RBFB 1630	16	30	6	70			6	8	■	1
A10101630809	HFF 1630.08		Z9 Alu	RBFB 1630	16	30	8	70			6	8	■	1
A10040313309	HFG 0313.03		Z9 Alu	SPG 0313	3	13	3	40			6	8	■	1

Burrs for machining non-ferrous metals, Z9 Alu

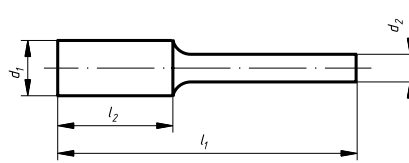

Ordering example: A10010313309

Further dimensions, cuts and shank lengths on request

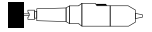

PG 1

Product number	Description	Shape	Cut	similar to DIN 8033	d ₁ mm	l ₂ mm	d ₂ mm	l ₁ mm	recommended for	Information on page 438				
A10070820609	HFL 0820.06		Z9 Alu	---	8	20	6	60			6	8	■	1
A10071020609	HFL 1020.06		Z9 Alu	KEL 1020	10	20	6	60			6	8	■	1
A10071225609	HFL 1225.06		Z9 Alu	KEL 1225	12	25	6	65			6	8	■	1
A10071230609	HFL 1230.06		Z9 Alu	KEL 1230	12	30	6	70			6	8	■	1
A10071230809	HFL 1230.08		Z9 Alu	KEL 1230	12	30	8	70			6	8	■	1
A10072040809	HFL 2040.08		Z9 Alu	KEL 2040	20	40	8	80			6	8	■	1
A10050618609	HFM 0618.06		Z9 Alu	SKM 0618	6	18	6	50			6	8	■	1

Z9 Alu – the burr for aluminium and non-ferrous metals

Ideal for

- Machining
- Chamfering
- Deburring

Advantages:

- High removal rate
- No clogging
- Long tool life

Tungsten-carbide burrs Cast

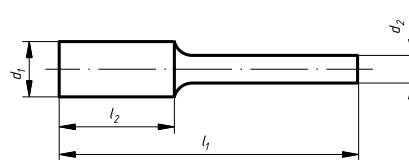

Ordering example: A10010616621

Further dimensions, cuts and shank lengths on request



PG 1

Product number	Description	Shape	Cut	similar to DIN 8033	d ₁ mm	l ₂ mm	d ₂ mm	l ₁ mm	recommended for	Information on page 438				
A10010616621	HFA 0616.06		Cast	ZYA 0616	6	16	6	50			5		■	1
A10010820621	HFA 0820.06		Cast	ZYA 0820	8	20	6	60			5		■	1
A10011020621	HFA 1020.06		Cast	ZYA 1020	10	20	6	60			5		■	1

Tungsten-carbide burrs Cast



Ordering example: A10010616621

Further dimensions, cuts and shank lengths on request

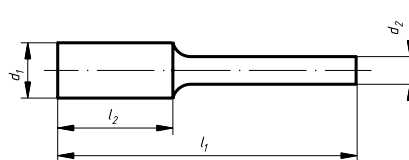

PG 1

Product number	Description	Shape	Cut	similar to DIN 8033	d ₁ mm	l ₂ mm	d ₂ mm	l ₁ mm	recommended for Information on page 438		
A10011225621	HFA 1225.06		Cast	ZYA 1225	12	25	6	65	5		1
A10020616621	HFC 0616.06		Cast	WRC 0616	6	16	6	50	5		1
A10020820621	HFC 0820.06		Cast	WRC 0820	8	20	6	60	5		1
A10021020621	HFC 1020.06		Cast	WRC 1020	10	20	6	60	5		1
A10021225621	HFC 1225.06		Cast	WRC 1225	12	25	6	65	5		1
A10030605621	HFD 0605.06		Cast	KUD 0605	6	5	6	50	5		1
A10030807621	HFD 0807.06		Cast	KUD 0807	8	7	6	47	5		1
A10031009621	HFD 1009.06		Cast	KUD 1009	10	9	6	49	5		1
A10031210621	HFD 1210.06		Cast	KUD 1210	12	10	6	51	5		1
A10060610621	HFE 0610.06		Cast	TRE 0610	6	10	6	50	5		1
A10060813621	HFE 0813.06		Cast	TRE 0813	8	13	6	53	5		1
A10061016621	HFE 1016.06		Cast	TRE 1016	10	16	6		5		1
A10061220621	HFE 1220.06		Cast	TRE 1220	12	20	6	60	5		1
A10100618621	HFF 0618.06		Cast	RBF 0618	6	18	6	50	5		1
A10100820621	HFF 0820.06		Cast	---	8	20	6	60	5		1
A10101020621	HFF 1020.06		Cast	RBF 1020	10	20	6	60	5		1
A10101225621	HFF 1225.06		Cast	RBF 1225	12	25	6	65	5		1
A10040618621	HFG 0618.06		Cast	SPG 0618	6	18	6	50	5		1
A10040820621	HFG 0820.06		Cast	---	8	20	6	60	5		1
A10041020621	HFG 1020.06		Cast	SPG 1020	10	20	6	60	5		1
A10041225621	HFG 1225.06		Cast	SPG 1225	12	25	6	65	5		1

Cast – the burr for cast material

Ideal for

- Fetting
- Deburring
- Beveling

Advantages:

- High stock removal capability
- Long tool life
- Smooth running and ergonomical

HM-burr Composite Coarse



Ordering example: A10180315323

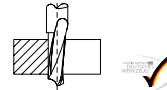
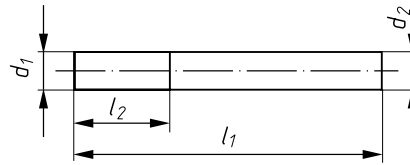

PG 1

Product number	Description	Cut	l ₁ mm	d ₁ mm	l ₂ mm	d ₂ mm	recommended for Information on page 438		
A10180315323	HFAS 0315.03	Composite Coarse	42	3	15	3		8	■ 1
A10180625623	HFAS 0625.06	Composite Coarse	64	6	25	6		8	■ 1
A10180828823	HFAS 0828.08	Composite Coarse	73	8	28	8		8	■ 1

Composite – the burr for fibre-reinforced materials

Thanks to the special fish-tail tooting the burrs can also be used for drilling and face milling. Due to the extra-long cutting element sawing operations will be possible and tool life will increase. The coarse cut (coarse) is perfectly suited for stationary use.

Ideal for

- Drilling
- Milling
- Sawing

Advantages:

- Extra-long cutting element
- Long tool life
- High profitability

HM-burr Composite Fine



Ordering example: A10180625624

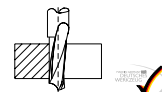
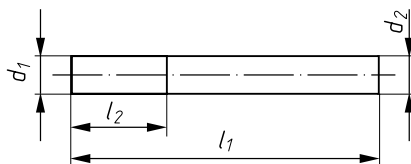

PG 1

Product number	Description	Cut	l ₁ mm	d ₁ mm	l ₂ mm	d ₂ mm	recommended for Information on page 438					
A10180625624	HFAS 0625.06	Composite Fine	64	6	25	6				8	■	1
A10180828824	HFAS 0828.08	Composite Fine	73	8	28	8				8	■	1
A101810301024	HFAS 1030.10	Composite Fine	77	10	30	10				8	■	1

Composite – the burr for fibre-reinforced materials

Thanks to the special fish-tail tooting the burrs can also be used for drilling and face milling. Due to the extra-long cutting element sawing operations will be possible and tool life will increase. The coarse cut (coarse) is perfectly suited for stationary use.

Ideal for

- Drilling
- Milling
- Sawing

Advantages:

- Extra-long cutting element
- Long tool-life
- High profitability



Tungsten-carbide Rasp burrs wood

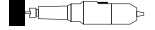
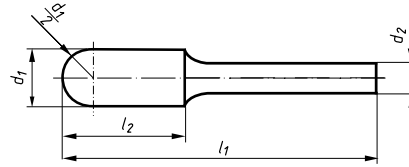

Ordering example: A10021225618

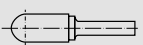
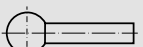

PG 1

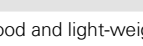
Product number	Description	Shape	Cut	d ₁ mm	l ₂ mm	d ₂ mm	l ₁ mm	recommended for Information on page 438					
A10021225618	HFC 1225.06		Wood	12	25	6	65	①			⑧	■	1
A10031210618	HFD 1210.06		Wood	12	10	6	50	①			⑧	■	1
A10061220618	HFE 1220.06		Wood	12	20	6	60	①			⑧	■	1
A10100618618	HFF 0618.06		Wood	6	18	6	58	①			⑧	■	1
A10100820618	HFF 0820.06		Wood	8	20	6	60	①			⑧	■	1

Wood – the milling cutter for wood and light-weight materials

Rasp burrs for wood are manufactured from fine grit tungsten carbide and achieve a service life far exceeding that of comparable HSS or stippled burrs. A rough cutting geometry means that, even where only light force is applied, the burrs are very efficient during cutting, achieving a high level of stock removal. In particular when working on wood and other materials for pattern construction the desired shapes can be achieved fast and accurately. Burrs and material remain cool and do not overheat.

Ideal for

- chamfering
- modelling
- smoothing

Advantages:

- very fast due to large rake angle
- long tool life thanks to carbide
- quiet, vibration-free running

Range of application:

- pattern construction and wood
- mold and cores
- soft materials

Example using Rasp burr for wood

Tungsten-carbide rotary files



Ordering example: A100106166140001

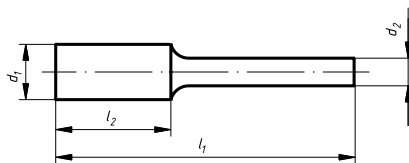

PG 1

Product number	Description	Shape	Cut	d ₁ mm	l ₂ mm	d ₂ mm	l ₁ mm	recommended for Information on page 438								
A100106166150001	HFAS 0616.06		ZF2	6	16	6	50	1	2	3	4	5	7	■	1	
A100106166140001	HFAS 0616.06		ZF3	6	16	6	50	1	2	3	4	5	7	■	1	
A100112256160001	HFAS 1225.06		ZF1	12	25	6	65	1	2	3	4	5	7	■	1	
A100112256150001	HFAS 1225.06		ZF2	12	25	6	65	1	2	3	4	5	7	■	1	
A10020616614	HFC 0616.06		ZF3	6	16	6	50	1	2	3	4	5	7	■	1	
A10021225616	HFC 1225.06		ZF1	12	25	6	65	1	2	3	4	5	7	■	1	
A10021225615	HFC 1225.06		ZF2	12	25	6	65	1	2	3	4	5	7	■	1	
A10031009615	HFD 1009.06		ZF2	10	9	6	49	1	2	3	4	5	7	■	1	
A10040618615	HFG 0618.06		ZF2	6	18	6	50	1	2	3	4	5	7	■	1	
A10040618614	HFG 0618.06		ZF3	6	18	6	50	1	2	3	4	5	7	■	1	
A10041230616	HFG 1230.06		ZF1	12	30	6	70	1	2	3	4	5	7	■	1	
A10041230615	HFG 1230.06		ZF2	12	30	6	70	1	2	3	4	5	7	■	1	
A10041230614	HFG 1230.06		ZF3	12	30	6	70	1	2	3	4	5	7	■	1	
A10051225615	HFM 1225.06		ZF2	12	25	6	65	1	2	3	4	5	7	■	1	

The micro-serration of the new tungsten carbide rotary files is based on the cutting geometry of a file and thus prevents clogging, even when removing soft materials.

The precision cut is achieved on CNC grinding machines, thus ensuring perfect concentricity and chatter-free working. The burrs remain sharp for a long time as a result, achieving a clean surface finish free of chatter marks. Rotary files are available in numerous sizes and shapes and three different cuts ranging from ZF1 (coarse) to ZF3 (fine). This means that the conditions of use can be optimised for each application with the result of the best surface finish. This means that the conditions of use can be optimised for each application with the result of the best surface finish.

Properties:

- Optimum surface finishes, owing to fine serration
- Long service life, owing to tungsten carbide
- No clogging

Particularly suitable for:

- Perfect surface finishes
- Composite materials
- Bores

Miniature burrs with multi-purpose cut

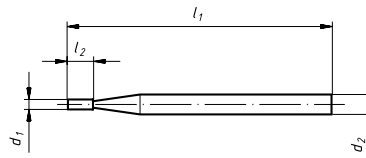

Ordering example: A10010104312

Further dimensions, cuts and shank lengths on request

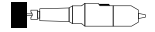

PG 1

Product number	Description	Shape	d ₁ mm	l ₂ mm	d ₂ mm	l ₁ mm	recommended for Information on page 438		
A10010104312	HFA 01004.03		1	4	3	40	2 3 4 7	■	1
A100101043120001	HFA 01504.03		1,5	4	3	40	2 3 4 7	■	1
A10010204312	HFA 02004.03		2	4	3	40	2 3 4 7	■	1
A10020104312	HFC 01004.03		1	4	3	40	2 3 4 7	■	1
A100201043120001	HFC 01504.03		1,5	4	3	40	2 3 4 7	■	1
A10020204312	HFC 02004.03		2	4	3	40	2 3 4 7	■	1
A10030101312	HFD 01001.03		1	0,9	3	40	2 3 4 7	■	1
A100301013120001	HFD 01501.03		1,5	1,35	3	40	2 3 4 7	■	1
A10030202312	HFD 02002.03		2	1,8	3	40	2 3 4 7	■	1
A10060104312	HFE 01504.03		1,5	4	3	40	2 3 4 7	■	1
A10100104312	HFF 01504.03		1,5	4	3	40	2 3 4 7	■	1
A10040104312	HFG 01504.03		1,5	4	3	40	2 3 4 7	■	1
A10050104312	HFM 01504.03		1,5	4	3	40	2 3 4 7	■	1

Application:

- tool manufacture
- precision engineering
- jewellery industry
- turbine manufacture

Materials to be processed:

- stainless steel
- non-ferrous metals
- zinc die casting
- soft ceramics
- titanium alloys

Useful hints:

- choose shortest overhang
- concentric running of the collet chuck is very important
- recommended speed: 70.000 rpm

Advantages:

- high dimensional accuracy
- minimal runout
- multi-purpose cut
- micro grain carbide
- precision ground cutting edges

Power Tool:

- We recommend our pneumatic grinder AMIN 72-013 GD, page 381

Miniature burrs in cut 5, shank 3 mm

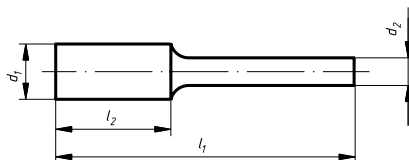

Ordering example: A10010204300

Further dimensions, cuts and shank lengths on request



PG 1

Product number	Description	Shape	Cut	similar to DIN 8033	d ₁ mm	l ₂ mm	d ₂ mm	l ₁ mm	recommended for Information on page 438		
A10010210305	HFA 0210.03		Z5	ZYA 0210	2	10	3	40	① ② ③ ④	⑦	■ 1
A10010313305	HFA 0313.03		Z5	ZYA 0313	3	13	3	40	① ② ③ ④	⑦	■ 1
A10010607305	HFA 0607.03		Z5	ZYA 0607	6	7	3	37	① ② ③ ④	⑦	■ 1
A10010613305	HFA 0613.03		Z5	ZYA 0613	6	13	3	43	① ② ③ ④	⑦	■ 1
A100102103050001	HFAS 0210.03		Z5	ZYA-S 0210	2	10	3	40	① ② ③ ④	⑦	■ 1
A100103133050001	HFAS 0313.03		Z5	ZYA-S 0313	3	13	3	40	① ② ③ ④	⑦	■ 1
A100106073050001	HFAS 0607.03		Z5	ZYA-S 0607	6	7	3	37	① ② ③ ④	⑦	■ 1
A100106133050001	HFAS 0613.03		Z5	ZYA-S 0613	6	13	3	43	① ② ③ ④	⑦	■ 1
A10020210305	HFC 0210.03		Z5	WRC 0210	2	10	3	40	① ② ③ ④	⑦	■ 1
A10020313305	HFC 0313.03		Z5	WRC 0313	3	13	3	40	① ② ③ ④	⑦	■ 1
A10020613305	HFC 0613.03		Z5	WRC 0613	6	13	3	43	① ② ③ ④	⑦	■ 1
A10030303305	HFD 0302.03		Z5	KUD 0302	3	2	3	40	① ② ③ ④	⑦	■ 1
A100304043050001	HFD 0403.03		Z5	KUD 0403	4	3	3	34	① ② ③ ④	⑦	■ 1
A10030606305	HFD 0605.03		Z5	KUD 0605	6	5	3	35	① ② ③ ④	⑦	■ 1
A10060307305	HFE 0307.03		Z5	TRE 0307	3	7	3	40	① ② ③ ④	⑦	■ 1
A10060610305	HFE 0610.03		Z5	TRE 0610	6	10	3	40	① ② ③ ④	⑦	■ 1
A10100307305	HFF 0307.03		Z5	RBF 0307	3	7	3	40	① ② ③ ④	⑦	■ 1
A10100313305	HFF 0313.03		Z5	RBF 0313	3	13	3	40	① ② ③ ④	⑦	■ 1
A10100613305	HFF 0613.03		Z5	RBF 0613	6	13	3	43	① ② ③ ④	⑦	■ 1
A10040307305	HFG 0307.03		Z5	SPG 0307	3	7	3	40	① ② ③ ④	⑦	■ 1
A10040313305	HFG 0313.03		Z5	SPG 0313	3	13	3	40	① ② ③ ④	⑦	■ 1
A10040613305	HFG 0613.03		Z5	SPG 0613	6	13	3	43	① ② ③ ④	⑦	■ 1
A10090307305	HFH 0307.03		Z5		3	7	3	40	① ② ③ ④	⑦	■ 1

Miniature burrs in cut 5, shank 3 mm

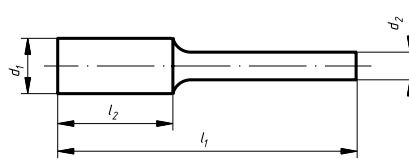

Ordering example: A10010204300

Further dimensions, cuts and shank lengths on request

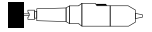

PG 1

Product number	Description	Shape	Cut	similar to DIN 8033	d ₁ mm	l ₂ mm	d ₂ mm	l ₁ mm	recommended for Information on page 438								
A10090613305	HFH 0613.03		Z5		6	13	3	43	①	②	③	④		⑦		■	1
A10010204300	HFI 0204.03		Z1		2,5	4	3	40			③	④		⑦		■	1
A10010408300	HFI 0408.03		Z1		4	8	3	50			③	④		⑦		■	1
A10050307305	HFM 0307.03		Z5	SKM 0307	3	7	3	40	①	②	③	④		⑦		■	1
A10050311305	HFM 0311.03		Z5	SKM 0311	3	11	3	40	①	②	③	④		⑦		■	1
A10050613305	HFM 0613.03		Z5	SKM 0613	6	13	3	43	①	②	③	④		⑦		■	1
A10120307305	HFN 0307.03		Z5	WKN 0307	3	7	3	40	①	②	③	④		⑦		■	1
A10120607305	HFN 0607.03		Z5	WKN 0607	6	7	3	37	①	②	③	④		⑦		■	1
A101203073050001	HFNS 0307.03		Z5	WKN-S 0307	3	7	3	40	①	②	③	④		⑦		■	1
A101206073050001	HFNS 0607.03		Z5	WKN-S 0607	6	7	3	37	①	②	③	④		⑦		■	1

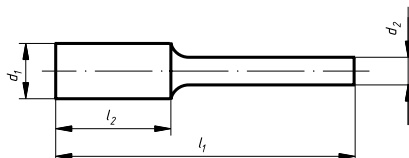
Burrs with extended shank length (shank length 200 mm)

Ordering example: A10011225603200

Further dimensions, cuts and shank lengths on request

PG 1

Product number	Description	Shape	Cut	d ₁ mm	l ₂ mm	d ₂ mm	l ₁ mm	recommended for			
									Information on page 438		
A10011225603200	HFA 1225.06 L		Z3	12	25	6	225	① ② ③ ④	⑦	■	1
A10011225608200	HFA 1225.06 L		Z7 Steel	12	25	6	225	① ② ③ ④	⑦	■	1
A10020616603200	HFC 0616.06 L		Z3	6	16	6	216	① ② ③ ④	⑦	■	1
A10020616608200	HFC 0616.06 L		Z7 Steel	6	16	6	216	① ② ③ ⑤	⑦	■	1
A10020820603200	HFC 0820.06 L		Z3	8	20	6	220	① ② ③ ④	⑦	■	1
A10020820608200	HFC 0820.06 L		Z7 Steel	8	20	6	220	① ② ③ ⑤	⑦	■	1
A10021020608200	HFC 1020.06 L		Z7 Steel	10	20	6	220	① ② ③ ⑤	⑦	■	1
A10021225608200	HFC 1225.06 L		Z7 Steel	12	25	6	225	① ② ③ ⑤	⑦	■	1
A10030605603200	HFD 0605.06 L		Z3	6	5	6	205	① ② ③ ④	⑦	■	1
A10030605608200	HFD 0605.06 L		Z7 Steel	6	5	6	205	① ② ③ ⑤	⑦	■	1
A10030807603200	HFD 0807.06 L		Z3	8	7	6	207	① ② ③ ④	⑦	■	1
A10030807608200	HFD 0807.06 L		Z7 Steel	8	7	6	207	① ② ③ ⑤	⑦	■	1
A10031009603200	HFD 1009.06 L		Z3	10	9	6	209	① ② ③ ④	⑦	■	1
A10031009608200	HFD 1009.06 L		Z7 Steel	10	9	6	209	① ② ③ ⑤	⑦	■	1
A10031210603200	HFD 1210.06 L		Z3	12	10	6	210	① ② ③ ④	⑦	■	1
A10031210608200	HFD 1210.06 L		Z7 Steel	12	10	6	210	① ② ③ ⑤	⑦	■	1
A10031210803200	HFD 1210.08 L		Z3	12	10	8	210	① ② ③ ④	⑦	■	1
A10031210808200	HFD 1210.08 L		Z7 Steel	12	10	8	210	① ② ③ ⑤	⑦	■	1
A10061220603200	HFE 1220.06 L		Z3	12	20	6	220	① ② ③ ④	⑦	■	1
A10061220608200	HFE 1220.06 L		Z7 Steel	12	20	6	220	① ② ③ ⑤	⑦	■	1
A10061220808200	HFE 1220.08 L		Z7 Steel	12	20	8	220	① ② ③ ⑤	⑦	■	1
A10100618603200	HFF 0618.06 L		Z3	6	18	6	218	① ② ③ ④	⑦	■	1
A10100618608200	HFF 0618.06 L		Z7 Steel	6	18	6	218	① ② ③ ⑤	⑦	■	1
A10101230808200	HFF 1230.08 L		Z7 Steel	12	30	8	230	① ② ③ ⑤	⑦	■	1
A10040618603200	HFG 0618.06 L		Z3	6	18	6	218	① ② ③ ④	⑦	■	1
A10040618608200	HFG 0618.06 L		Z7 Steel	6	18	6	218	① ② ③ ⑤	⑦	■	1
A10041230808200	HFG 1230.08 L		Z7 Steel	12	30	8	230	① ② ③ ⑤	⑦	■	1
A10091020603200	HFH 1020.06 L		Z3	10	20	6	220	① ② ③ ④	⑦	■	1
A10091020608200	HFH 1020.06 L		Z7 Steel	10	20	6	220	① ② ③ ⑤	⑦	■	1

Safety instructions: Recommended operating speed for major exposed shank lengths

For a safe use it will be necessary to hold the tool to the workpiece before starting the machine and/or insert it into the boreholes or ducts. Contact with the workpiece must be ensured until the machine is deactivated. If permanent contact with the workpiece cannot be ensured, the machine should run at idling speed..

Reduced speeds for Tungsten-carbide burrs with extra long shank (150/200 mm)

Tool diameter d1 mm	6	8	10	12	12
Shank diameter d2 mm	6	6	6	6	8
Permitted idling speed without workpiece contact (1/min)	4.000	3.200	2.800	2.200	3.600
Permitted reduced operating speed with workpiece contact (1/min)	13.000	10.000	8.000	7.000	7.000

Burrs with extended shank length (shank length 150 mm)

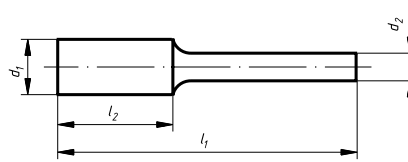

Ordering example: A10020820622150

Further dimensions, cuts and shank lengths on request

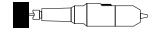

Product number	Description	Shape	Cut	d ₁ mm	l ₂ mm	d ₂ mm	l ₁ mm	recommended for Information on page 438	PG 1	
A10020820622150	HFC 0820.06 BASE-X		ZX	8	20	6	170	① ② ③ ④ ⑤ ⑥ ⑦	■	1
A10021020622150	HFC 1020.06 BASE-X		ZX	10	20	6	170	① ② ③ ④ ⑤ ⑥ ⑦	■	1
A10021225622150	HFC 1225.06 BASE-X		ZX	12	25	6	175	① ② ③ ④ ⑤ ⑥ ⑦	■	1
A10030807622150	HFD 0807.06 BASE-X		ZX	8	7	6	157	① ② ③ ④ ⑤ ⑥ ⑦	■	1
A10031009622150	HFD 1009.06 BASE-X		ZX	10	9	6	159	① ② ③ ④ ⑤ ⑥ ⑦	■	1
A10100820622150	HFF 0820.06 BASE-X		ZX	8	20	6	170	① ② ③ ④ ⑤ ⑥ ⑦	■	1
A10101225622150	HFF 1225.06 BASE-X		ZX	12	25	6	175	① ② ③ ④ ⑤ ⑥ ⑦	■	1

Safety instructions: Recommended operating speed for major exposed shank lengths

For a safe use it will be necessary to hold the tool to the workpiece before starting the machine and/or insert it into the boreholes or ducts. Contact with the workpiece must be ensured until the machine is deactivated. If permanent contact with the workpiece cannot be ensured, the machine should run at idling speed.

Reduced speeds for Tungsten-carbide burrs with extra long shank (150/200 mm)

Tool diameter d1 mm	6	8	10	12	12
Shank diameter d2 mm	6	6	6	6	8
Permitted idling speed without workpiece contact (1/min)	4.000	3.200	2.800	2.200	3.600
Permitted reduced operating speed with workpiece contact (1/min)	13.000	10.000	8.000	7.000	7.000

Tools for stationary use



PG 1

Differential drill, radius mill, shank-end mill, die mill, profile mill

delivery on request

Range of application:

- Tool construction
- Turbine construction
- Aerospace industry
- General machine building

In addition to rotary burrs, we also produce tungsten carbide milling tools in special shapes and sizes for stationary application.

We supply these milling cutters with a diameter **of 20 mm** maximum diameter and with a maximum length **of 250 mm**; they differ from our extensive standard range by the shape, tool material and geometry (rake, clearance and helix angles).

Engraving cutters of solid carbide single flute type

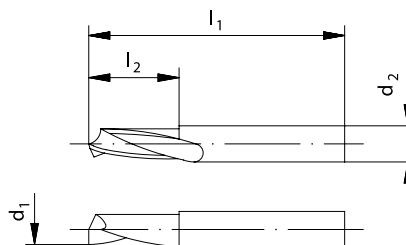

Ordering example: A13150030337102

Further dimensions, cuts and shank lengths on request.

Unless otherwise specified, the tolerances are as DIN 7468



PG 1

Product number	Description	d ₁ mm	l ₂ mm	d ₂ mm	l ₁ mm	recommended for	Information on page 438				
A13150030337102	HGE 0207.03	2	7	3	40			6	8	■	1
A13150030337103	HGE 0307.03	3	7	3	40			6	8	■	1

Application:

Very well suited for the machining of light metals, non-ferrous metals, plastics and for high-speed-machining of aluminium parts. Cutters with mirror finished flute allow for ideal chip removal and avoid clogging.

Recommended cutting speeds

Main group of materials	Sub-group	Hardness (HB)	Strength (N/mm ²)	Optimal cutting speed (m/min)
Aluminium, Magnesium	Al, Mg non alloyed	≤ 100	≤ 350	≤ 400
	Al alloyed Si < 0,5%	≤ 150	≤ 500	≤ 400
	Al alloyed Si ≥ 0,5 < 10 %	≤ 120	≤ 400	≤ 100
	Al alloyed Si ≥ 10 %, Mg-all., Al-Whisker	≤ 120	≤ 400	≤ 70
Plastics	Thermoplastics	-	-	≤ 150
	Thermo-setting plastics	-	-	-

Shape A, Cylindrical

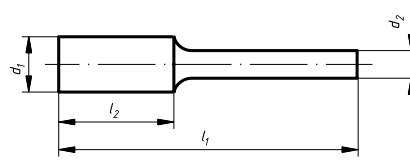

Ordering example: A10010210305

Further dimensions, cuts and shank lengths on request

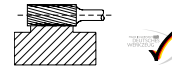
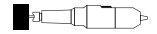

PG 1

Product number	Description	Cut	similar to DIN 8033	d ₁ mm	l ₂ mm	d ₂ mm	l ₁ mm	recommended for Information on page 438		
A10010210305	HFA 0210.03	Z5	ZYA 0210	2	10	3	40	① ② ③ ④ ⑦	■	1
A10010313303	HFA 0313.03	Z3	ZYA 0313	3	13	3	40	① ② ③ ④ ⑦	■	1
A10010313304	HFA 0313.03	Z4	ZYA 0313	3	13	3	40	② ③ ④ ⑦ ⑧	■	1
A10010313305	HFA 0313.03	Z5	ZYA 0313	3	13	3	40	① ② ③ ④ ⑦	■	1
A10010313308	HFA 0313.03	Z7 Steel	ZYA 0313	3	13	3	40	① ② ③ ⑤ ⑦	■	1
A10010313309	HFA 0313.03	Z9 Alu	ZYA 0313	3	13	3	40	⑥ ⑧	■	1
A10010413603	HFA 0413.06	Z3	ZYA 0413	4	13	6	50	① ② ③ ④ ⑦	■	1
A10010413608	HFA 0413.06	Z7 Steel	ZYA 0413	4	13	6	50	① ② ③ ⑤ ⑦	■	1
A10010607305	HFA 0607.03	Z5	ZYA 0607	6	7	3	37	① ② ③ ④ ⑦	■	1
A10010613305	HFA 0613.03	Z5	ZYA 0613	6	13	3	43	① ② ③ ④ ⑦	■	1
A10010613308	HFA 0613.03	Z7 Steel	ZYA 0613	6	13	3	43	① ② ③ ⑤ ⑦	■	1
A10010616602	HFA 0616.06	Z2	ZYA 0616	6	16	6	50	① ⑤ ⑥ ⑧	■	1
A10010616603	HFA 0616.06	Z3	ZYA 0616	6	16	6	50	① ② ③ ④ ⑦	■	1
A10010616604	HFA 0616.06	Z4	ZYA 0616	6	16	6	50	② ③ ④ ⑦ ⑧	■	1
A10010616605	HFA 0616.06	Z5	ZYA 0616	6	16	6	50	① ② ③ ④ ⑦	■	1
A10010616608	HFA 0616.06	Z7 Steel	ZYA 0616	6	16	6	50	① ② ③ ⑤ ⑦	■	1
A10010616609	HFA 0616.06	Z9 Alu	ZYA 0616	6	16	6	50	⑥ ⑧	■	1
A10010616620	HFA 0616.06	Z42 Inox/Steel	ZYA 0616	6	16	6	50	① ② ③ ④	■	1
A10010616621	HFA 0616.06	Cast	ZYA 0616	6	16	6	50	⑤	■	1
A10010820603	HFA 0820.06	Z3	ZYA 0820	8	20	6	60	① ② ③ ④ ⑦	■	1
A10010820604	HFA 0820.06	Z4	ZYA 0820	8	20	6	60	② ③ ④ ⑦ ⑧	■	1
A10010820605	HFA 0820.06	Z5	ZYA 0820	8	20	6	60	① ② ③ ④ ⑦	■	1
A10010820608	HFA 0820.06	Z7 Steel	ZYA 0820	8	20	6	60	① ② ③ ⑤ ⑦	■	1
A10010820620	HFA 0820.06	Z42 Inox/Steel	ZYA 0820	8	20	6	60	① ② ③ ④	■	1
A10010820621	HFA 0820.06	Cast	ZYA 0820	8	20	6	60	⑤	■	1
A10011013603	HFA 1013.06	Z3	ZYA 1013	10	13	6	53	① ② ③ ④ ⑦	■	1
A10011013608	HFA 1013.06	Z7 Steel	ZYA 1013	10	13	6	53	① ② ③ ⑤ ⑦	■	1
A10011020603	HFA 1020.06	Z3	ZYA 1020	10	20	6	60	① ② ③ ④ ⑦	■	1
A10011020604	HFA 1020.06	Z4	ZYA 1020	10	20	6	60	② ③ ④ ⑦ ⑧	■	1
A10011020608	HFA 1020.06	Z7 Steel	ZYA 1020	10	20	6	60	① ② ③ ⑤ ⑦	■	1
A10011020620	HFA 1020.06	Z42 Inox/Steel	ZYA 1020	10	20	6	60	① ② ③ ④	■	1
A10011020621	HFA 1020.06	Cast	ZYA 1020	10	20	6	60	⑤	■	1
A10011025604	HFA 1025.06	Z4	ZYA 1025	10	25	6	65	② ③ ④ ⑦ ⑧	■	1
A10011025608	HFA 1025.06	Z7 Steel	ZYA 1025	10	25	6	65	① ② ③ ⑤ ⑦	■	1
A10011025803	HFA 1025.08	Z3	ZYA 1025	10	25	8	65	① ② ③ ④ ⑦	■	1
A10011225603	HFA 1225.06	Z3	ZYA 1225	12	25	6	65	① ② ③ ④ ⑦	■	1
A10011225604	HFA 1225.06	Z4	ZYA 1225	12	25	6	65	② ③ ④ ⑦ ⑧	■	1

Shape A, Cylindrical

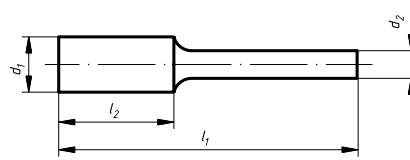

Ordering example: A10010210305

Further dimensions, cuts and shank lengths on request

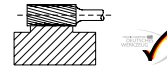
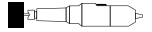

PG 1

Product number	Description	Cut	similar to DIN 8033	d ₁ mm	l ₂ mm	d ₂ mm	l ₁ mm	recommended for Information on page 438		
A10011225605	HFA 1225.06	Z5	ZYA 1225	12	25	6	65	① ② ③ ④ ⑦	■	1
A10011225608	HFA 1225.06	Z7 Steel	ZYA 1225	12	25	6	65	① ② ③ ⑤ ⑦	■	1
A10011225609	HFA 1225.06	Z9 Alu	ZYA 1225	12	25	6	65	⑥ ⑧	■	1
A10011225620	HFA 1225.06	Z42 Inox/Steel	ZYA 1225	12	25	6	65	① ② ③ ④	■	1
A10011225621	HFA 1225.06	Cast	ZYA 1225	12	25	6	65	⑤	■	1
A10011225804	HFA 1225.08	Z4	ZYA 1225	12	25	8	65	② ③ ④ ⑦ ⑧	■	1
A10011225809	HFA 1225.08	Z9 Alu	ZYA 1225	12	25	8	65	⑥ ⑧	■	1
A10011625603	HFA 1625.06	Z3	ZYA 1625	16	25	6	65	① ② ③ ④ ⑦	■	1
A10011625608	HFA 1625.06	Z7 Steel	ZYA 1625	16	25	6	65	① ② ③ ⑤ ⑦	■	1
A10011625609	HFA 1625.06	Z9 Alu	ZYA 1625	16	25	6	65	⑥ ⑧	■	1
A10011625809	HFA 1625.08	Z9 Alu	ZYA 1625	16	25	8	65	⑥ ⑧	■	1

Shape A, Cylindrical BASE-X

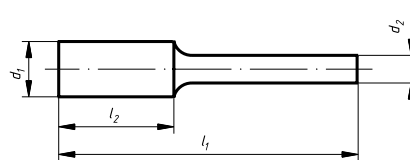

Ordering example: A10010313322

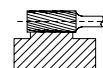

PG 1

Product number	Description	Cut	similar to DIN 8033	d ₁ mm	l ₂ mm	d ₂ mm	l ₁ mm	recommended for Information on page 438		
A10010313322	HFA 0313.03 BASE-X	ZX	ZYA 0313	3	13	3	40	① ② ③ ④ ⑤ ⑥ ⑦	■	10
A10010616622	HFA 0616.06 BASE-X	ZX	ZYA 0616	6	16	6	50	① ② ③ ④ ⑤ ⑥ ⑦	■	10
A10010820622	HFA 0820.06 BASE-X	ZX	ZYA 0820	8	20	6	60	① ② ③ ④ ⑤ ⑥ ⑦	■	10
A5001082062214	HFA 0820.06 BASE-X	ZX	ZYA 8020	8	20	1/4"	60	① ② ③ ④ ⑤ ⑥ ⑦	■	10
A10011020622	HFA 1020.06 BASE-X	ZX	ZYA 1020	10	20	6	60	① ② ③ ④ ⑤ ⑥ ⑦	■	10
A5001102062214	HFA 1020.06 BASE-X	ZX	ZYA 1020	10	20	1/4"	60	① ② ③ ④ ⑤ ⑥ ⑦	■	10

Shape A, Cylindrical BASE-X



Ordering example: A10010313322

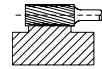
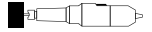
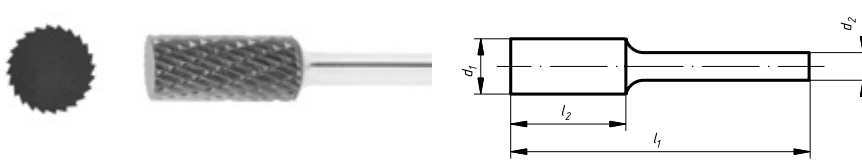

PG 1

Product number	Description	Cut	similar to DIN 8033	d ₁ mm	l ₂ mm	d ₂ mm	l ₁ mm	recommended for Information on page 438		
A10011225622	HFA 1225.06 BASE-X	ZX	ZYA 1225	12	25	6	65	① ② ③ ④ ⑤ ⑥ ⑦	■	5
A5001122562214	HFA 1225.06 BASE-X	ZX	ZYA 1225	12	25	1/4"	65	① ② ③ ④ ⑤ ⑥ ⑦	■	5

Shape A, Cylindrical, with end cut



Ordering example: A100102103050001

Further dimensions, cuts and shank lengths on request

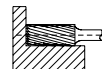
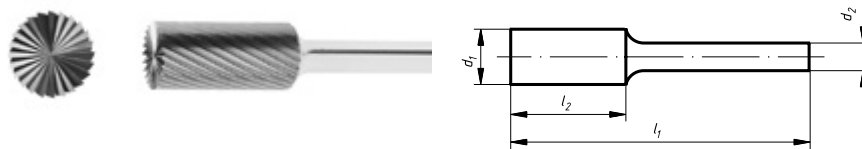
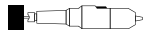

PG 1

Product number	Description	Cut	similar to DIN 8033	d ₁ mm	l ₂ mm	d ₂ mm	l ₁ mm	recommended for Information on page 438		
A100102103050001	HFAS 0210.03	Z5	ZYA-S 0210	2	10	3	40	① ② ③ ④ ⑦	■	1
A100103133030001	HFAS 0313.03	Z3	ZYA-S 0313	3	13	3	40	① ② ③ ④ ⑦	■	1
A100103133040001	HFAS 0313.03	Z4	ZYA-S 0313	3	13	3	40	② ③ ④ ⑦ ⑧	■	1
A100103133050001	HFAS 0313.03	Z5	ZYA-S 0313	3	13	3	40	① ② ③ ④ ⑦	■	1
A100103133080001	HFAS 0313.03	Z7 Steel	ZYA-S 0313	3	13	3	40	① ② ③ ⑤ ⑦	■	1
A100104136030001	HFAS 0413.06	Z3	ZYA-S 0413	4	13	6	50	① ② ③ ④ ⑦	■	1
A100104136080001	HFAS 0413.06	Z7 Steel	ZYA-S 0413	4	13	6	50	① ② ③ ⑤ ⑦	■	1
A100106073050001	HFAS 0607.03	Z5	ZYA-S 0607	6	7	3	37	① ② ③ ④ ⑦	■	1
A100106133050001	HFAS 0613.03	Z5	ZYA-S 0613	6	13	3	43	① ② ③ ④ ⑦	■	1
A100106133080001	HFAS 0613.03	Z7 Steel	ZYA-S 0613	6	13	3	43	① ② ③ ⑤ ⑦	■	1
A100106166030001	HFAS 0616.06	Z3	ZYA-S 0616	6	16	6	50	① ② ③ ④ ⑦	■	1
A100106166040001	HFAS 0616.06	Z4	ZYA-S 0616	6	16	6	50	② ③ ④ ⑦ ⑧	■	1
A100106166050001	HFAS 0616.06	Z5	ZYA-S 0616	6	16	6	50	① ② ③ ④ ⑦	■	1
A100106166080001	HFAS 0616.06	Z7 Steel	ZYA-S 0616	6	16	6	50	① ② ③ ⑤ ⑦	■	1
A100108206030001	HFAS 0820.06	Z3	ZYA-S 0820	8	20	6	60	① ② ③ ④ ⑦	■	1
A100108206040001	HFAS 0820.06	Z4	ZYA-S 0820	8	20	6	60	② ③ ④ ⑦ ⑧	■	1
A100108206050001	HFAS 0820.06	Z5	ZYA-S 0820	8	20	6	60	① ② ③ ④ ⑦	■	1
A100108206080001	HFAS 0820.06	Z7 Steel	ZYA-S 0820	8	20	6	60	① ② ③ ⑤ ⑦	■	1

Shape A, Cylindrical, with end cut

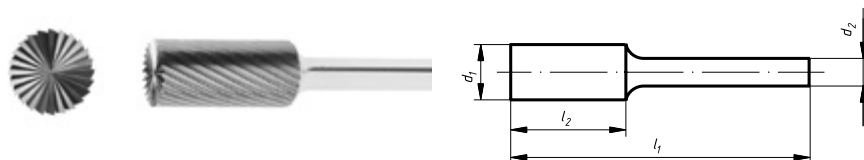

Ordering example: A100102103050001

Further dimensions, cuts and shank lengths on request



PG 1

Product number	Description	Cut	similar to DIN 8033	d ₁ mm	l ₂ mm	d ₂ mm	l ₁ mm	recommended for Information on page 438		
A100110136030001	HFAS 1013.06	Z3	ZYA-S 1013	10	13	6	53	① ② ③ ④ ⑦	■	1
A100110136080001	HFAS 1013.06	Z7 Steel	ZYA-S 1013	10	13	6	53	① ② ③ ⑤ ⑦	■	1
A100110206030001	HFAS 1020.06	Z3	ZYA-S 1020	10	20	6	60	① ② ③ ④ ⑦	■	1
A100110206040001	HFAS 1020.06	Z4	ZYA-S 1020	10	20	6	60	② ③ ④ ⑦ ⑧	■	1
A100110206080001	HFAS 1020.06	Z7 Steel	ZYA-S 1020	10	20	6	60	① ② ③ ⑤ ⑦	■	1
A100110256040001	HFAS 1025.06	Z4	ZYA-S 1025	10	25	6	65	② ③ ④ ⑦ ⑧	■	1
A100110256080001	HFAS 1025.06	Z7 Steel	ZYA-S 1025	10	25	6	65	① ② ③ ⑤ ⑦	■	1
A100112256030001	HFAS 1225.06	Z3	ZYA-S 1225	12	25	6	65	① ② ③ ④ ⑦	■	1
A100112256040001	HFAS 1225.06	Z4	ZYA-S 1225	12	25	6	65	② ③ ④ ⑦ ⑧	■	1
A100112256050001	HFAS 1225.06	Z5	ZYA-S 1225	12	25	6	65	① ② ③ ④ ⑦	■	1
A100112256080001	HFAS 1225.06	Z7 Steel	ZYA-S 1225	12	25	6	65	① ② ③ ⑤ ⑦	■	1
A100112258040001	HFAS 1225.08	Z4	ZYA-S 1225	12	25	8	65	② ③ ④ ⑦ ⑧	■	1
A100112258080001	HFAS 1225.08	Z7 Steel	ZYA-S 1225	12	25	8	65	① ② ③ ⑤ ⑦	■	1
A100116256030001	HFAS 1625.06	Z3	ZYA-S 1625	16	25	6	65	① ② ③ ④ ⑦	■	1
A100116256080001	HFAS 1625.06	Z7 Steel	ZYA-S 1625	16	25	6	65	① ② ③ ⑤ ⑦	■	1

Shape C, Cylindrical round nose

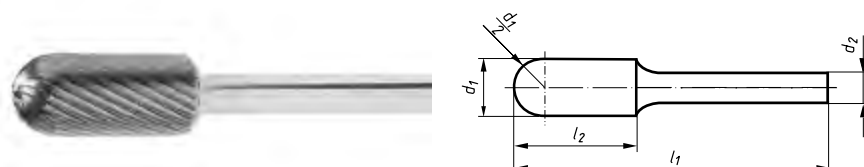

Ordering example: A10020210305

Further dimensions, cuts and shank lengths on request



PG 1

Product number	Description	Cut	similar to DIN 8033	d ₁ mm	l ₂ mm	d ₂ mm	l ₁ mm	recommended for Information on page 438		
A10020210305	HFC 0210.03	Z5	WRC 0210	2	10	3	40	① ② ③ ④ ⑦	■	1
A10020210308	HFC 0210.03	Z7 Steel	WRC 0210	2	10	3	40	① ② ③ ⑤ ⑦	■	1
A10020313302	HFC 0313.03	Z2	WRC 0313	3	13	3	40	① ⑤ ⑥ ⑧	■	1
A10020313303	HFC 0313.03	Z3	WRC 0313	3	13	3	40	① ② ③ ④ ⑦	■	1
A10020313304	HFC 0313.03	Z4	WRC 0313	3	13	3	40	② ③ ④ ⑦ ⑧	■	1

● Inox/Steel
 ● Steel
 ● Aluminium
 ● Stone
 ● Cast material
 ● Plastic
 ● Titanium

Shape C, Cylindrical round nose

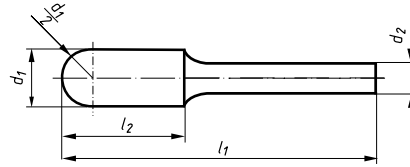

Ordering example: A10020210305

Further dimensions, cuts and shank lengths on request

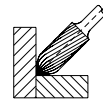
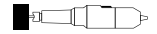

PG 1

Product number	Description	Cut	similar to DIN 8033	d ₁ mm	l ₂ mm	d ₂ mm	l ₁ mm	recommended for		
Information on page 438										
A10020313305	HFC 0313.03	Z5	WRC 0313	3	13	3	40	① ② ③ ④	⑦	■ 1
A10020313308	HFC 0313.03	Z7 Steel	WRC 0313	3	13	3	40	① ② ③ ⑤	⑦	■ 1
A10020313309	HFC 0313.03	Z9 Alu	WRC 0313	3	13	3	40		⑥ ⑧	■ 1
A10020413603	HFC 0413.06	Z3	WRC 0413	4	13	6	50	① ② ③ ④	⑦	■ 1
A10020413604	HFC 0413.06	Z4	WRC 0413	4	13	6	50	② ③ ④	⑦ ⑧	■ 1
A10020413608	HFC 0413.06	Z7 Steel	WRC 0413	4	13	6	50	① ② ③ ⑤	⑦	■ 1
A10020613305	HFC 0613.03	Z5	WRC 0613	6	13	3	43	① ② ③ ④	⑦	■ 1
A10020613308	HFC 0613.03	Z7 Steel	WRC 0613	6	13	3	43	① ② ③ ⑤	⑦	■ 1
A10020616601	HFC 0616.06	Z1	WRC 0616	6	16	6	50		⑥ ⑧	■ 1
A10020616602	HFC 0616.06	Z2	WRC 0616	6	16	6	50	①	⑤ ⑥ ⑧	■ 1
A10020616603	HFC 0616.06	Z3	WRC 0616	6	16	6	50	① ② ③ ④	⑦	■ 1
A10020616604	HFC 0616.06	Z4	WRC 0616	6	16	6	50	② ③ ④	⑦ ⑧	■ 1
A10020616605	HFC 0616.06	Z5	WRC 0616	6	16	6	50	① ② ③ ④	⑦	■ 1
A10020616608	HFC 0616.06	Z7 Steel	WRC 0616	6	16	6	50	① ② ③ ⑤	⑦	■ 1
A10020616609	HFC 0616.06	Z9 Alu	WRC 0616	6	16	6	50		⑥ ⑧	■ 1
A10020616620	HFC 0616.06	Z42 Inox/Steel	WRC 0616	6	16	6	50	① ② ③ ④		■ 1
A10020616621	HFC 0616.06	Cast	WRC 0616	6	16	6	50		⑤	■ 1
A10020820603	HFC 0820.06	Z3	WRC 0820	8	20	6	60	① ② ③ ④	⑦	■ 1
A10020820604	HFC 0820.06	Z4	WRC 0820	8	20	6	60	② ③ ④	⑦ ⑧	■ 1
A10020820605	HFC 0820.06	Z5	WRC 0820	8	20	6	60	① ② ③ ④	⑦	■ 1
A10020820606	HFC 0820.06	Z6	WRC 0820	8	20	6	60	② ③ ④	⑦ ⑧	■ 1
A10020820608	HFC 0820.06	Z7 Steel	WRC 0820	8	20	6	60	① ② ③ ⑤	⑦	■ 1
A10020820609	HFC 0820.06	Z9 Alu	WRC 0820	8	20	6	60		⑥ ⑧	■ 1
A10020820620	HFC 0820.06	Z42 Inox/Steel	WRC 0820	8	20	6	60	① ② ③ ④		■ 1
A10020820621	HFC 0820.06	Cast	WRC 0820	8	20	6	60		⑤	■ 1
A10021020603	HFC 1020.06	Z3	WRC 1020	10	20	6	60	① ② ③ ④	⑦	■ 1
A10021020604	HFC 1020.06	Z4	WRC 1020	10	20	6	60	② ③ ④	⑦ ⑧	■ 1
A10021020605	HFC 1020.06	Z5	WRC 1020	10	20	6	60	① ② ③ ④	⑦	■ 1
A10021020606	HFC 1020.06	Z6	WRC 1020	10	20	6	60	② ③ ④	⑦ ⑧	■ 1
A10021020608	HFC 1020.06	Z7 Steel	WRC 1020	10	20	6	60	① ② ③ ⑤	⑦	■ 1
A10021020620	HFC 1020.06	Z42 Inox/Steel	WRC 1020	10	20	6	60	① ② ③ ④		■ 1
A10021020621	HFC 1020.06	Cast	WRC 1020	10	20	6	60		⑤	■ 1
A10021020804	HFC 1020.08	Z4	WRC 1020	10	20	8	60	② ③ ④	⑦ ⑧	■ 1
A10021020808	HFC 1020.08	Z7 Steel	WRC 1020	10	20	8	60	① ② ③ ⑤	⑦	■ 1
A10021025608	HFC 1025.06	Z7 Steel	WRC 1025	10	25	6	65	① ② ③ ⑤	⑦	■ 1
A10021225601	HFC 1225.06	Z1	WRC 1225	12	25	6	65		⑥ ⑧	■ 1
A10021225602	HFC 1225.06	Z2	WRC 1225	12	25	6	65	①	⑤ ⑥ ⑧	■ 1

Shape C, Cylindrical round nose

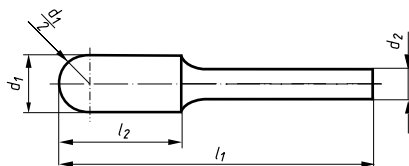

Ordering example: A10020210305

Further dimensions, cuts and shank lengths on request

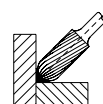

PG 1

Product number	Description	Cut	similar to DIN 8033	d ₁ mm	l ₂ mm	d ₂ mm	l ₁ mm	recommended for Information on page 438		
A10021225603	HFC 1225.06	Z3	WRC 1225	12	25	6	65	① ② ③ ④ ⑦	■	1
A10021225604	HFC 1225.06	Z4	WRC 1225	12	25	6	65	② ③ ④ ⑦ ⑧	■	1
A10021225605	HFC 1225.06	Z5	WRC 1225	12	25	6	65	① ② ③ ④ ⑦	■	1
A10021225606	HFC 1225.06	Z6	WRC 1225	12	25	6	65	② ③ ④ ⑦ ⑧	■	1
A10021225608	HFC 1225.06	Z7 Steel	WRC 1225	12	25	6	65	① ② ③ ⑤ ⑦	■	1
A10021225609	HFC 1225.06	Z9 Alu	WRC 1225	12	25	6	65	⑥ ⑧	■	1
A10021225620	HFC 1225.06	Z42 Inox/Steel	WRC 1225	12	25	6	65	① ② ③ ④	■	1
A10021225621	HFC 1225.06	Cast	WRC 1225	12	25	6	65	⑤	■	1
A10021225803	HFC 1225.08	Z3	WRC 1225	12	25	8	65	① ② ③ ④ ⑦	■	1
A10021225808	HFC 1225.08	Z7 Steel	WRC 1225	12	25	8	65	① ② ③ ⑤ ⑦	■	1
A10021225809	HFC 1225.08	Z9 Alu	WRC 1225	12	25	8	65	⑥ ⑧	■	1
A10021625603	HFC 1625.06	Z3	WRC 1625	16	25	6	65	① ② ③ ④ ⑦	■	1
A10021625608	HFC 1625.06	Z7 Steel	WRC 1625	16	25	6	65	① ② ③ ⑤ ⑦	■	1
A10021625609	HFC 1625.06	Z9 Alu	WRC 1625	16	25	6	65	⑥ ⑧	■	1
A10021625803	HFC 1625.08	Z3	WRC 1625	16	25	8	65	① ② ③ ④ ⑦	■	1

Shape C, Cylindrical round nose BASE-X



Ordering example: A10020313322

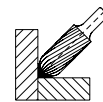
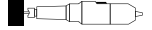
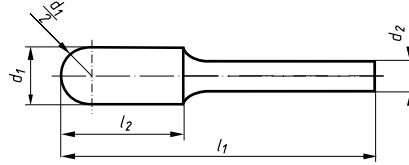

PG 1

Product number	Description	Cut	similar to DIN 8033	d ₁ mm	l ₂ mm	d ₂ mm	l ₁ mm	recommended for Information on page 438		
A10020313322	HFC 0313.03 BASE-X	ZX	WRC 0313	3	13	3	40	① ② ③ ④ ⑤ ⑥ ⑦	■	10
A10020613322	HFC 0613.03 BASE-X	ZX	WRC 0613	6	13	3	43	① ② ③ ④ ⑤ ⑥ ⑦	■	10
A10020616622	HFC 0616.06 BASE-X	ZX	WRC 0616	6	16	6	50	① ② ③ ④ ⑤ ⑥ ⑦	■	10
A5002061662214	HFC 0616.06 BASE-X	ZX	WRC 0616	6	16	1/4"	50	① ② ③ ④ ⑤ ⑥ ⑦	■	10
A10020820622	HFC 0820.06 BASE-X	ZX	WRC 0820	8	20	6	60	① ② ③ ④ ⑤ ⑥ ⑦	■	10
A5002082062214	HFC 0820.06 BASE-X	ZX	WRC 0820	8	20	1/4"	60	① ② ③ ④ ⑤ ⑥ ⑦	■	10
A10020820622150	HFC 0820.06 BASE-X	ZX	WRC 0820	8	20	6	170	① ② ③ ④ ⑤ ⑥ ⑦	■	10
A10021020622	HFC 1020.06 BASE-X	ZX	WRC 1020	10	20	6	60	① ② ③ ④ ⑤ ⑥ ⑦	■	10
A5002102062214	HFC 1020.06 BASE-X	ZX	WRC 1020	10	20	1/4"	60	① ② ③ ④ ⑤ ⑥ ⑦	■	10
A10021020622150	HFC 1020.06 BASE-X	ZX	WRC 1020	10	20	6	170	① ② ③ ④ ⑤ ⑥ ⑦	■	10
A10021225622	HFC 1225.06 BASE-X	ZX	WRC 1225	12	25	6	65	① ② ③ ④ ⑤ ⑥ ⑦	■	5
A5002122562214	HFC 1225.06 BASE-X	ZX	WRC 1225	12	25	1/4"	65	① ② ③ ④ ⑤ ⑥ ⑦	■	5
A10021225622150	HFC 1225.06 BASE-X	ZX	WRC 1225	12	25	6	175	① ② ③ ④ ⑤ ⑥	■	5

Shape D, Spherical



Ordering example: A10030303302

Further dimensions, cuts and shank lengths on request

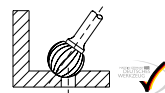
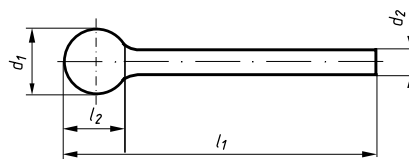

PG 1

Product number	Description	Cut	similar to DIN 8033	d ₁ mm	l ₂ mm	d ₂ mm	l ₁ mm	recommended for Information on page 438		
A10030303302	HFD 0302.03	Z2	KUD 0302	3	2	3	40	① ⑤ ⑥ ⑧	■	1
A10030303303	HFD 0302.03	Z3	KUD 0302	3	2	3	40	① ② ③ ④ ⑦	■	1
A10030303304	HFD 0302.03	Z4	KUD 0302	3	2	3	40	② ③ ④ ⑦ ⑧	■	1
A10030303305	HFD 0302.03	Z5	KUD 0302	3	2	3	40	① ② ③ ④ ⑦	■	1
A10030303308	HFD 0302.03	Z7 Steel	KUD 0302	3	2	3	40	① ② ③ ⑤ ⑦	■	1
A10030403309	HFD 0403.03	Z9 Alu	KUD 0403	4	3	3	34	⑥ ⑧	■	1
A10030403050001	HFD 0403.03	Z5	KUD 0403	4	3	3	34	① ② ③ ④ ⑦	■	1
A10030403080001	HFD 0403.03	Z7 Steel	KUD 0403	4	3	3	34	① ② ③ ⑤ ⑦	■	1
A10030404603	HFD 0403.06	Z3	KUD 0403	4	3	6	50	① ② ③ ④ ⑦	■	1

Shape D, Spherical

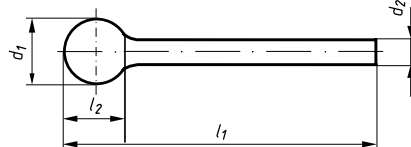

Ordering example: A10030303302

Further dimensions, cuts and shank lengths on request

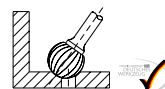

PG 1

Product number	Description	Cut	similar to DIN 8033	d ₁ mm	l ₂ mm	d ₂ mm	l ₁ mm	recommended for	Information on page 438		
A10030404604	HFD 0403.06	Z4	KUD 0403	4	3	6	50	2 3 4	7 8	■	1
A10030404608	HFD 0403.06	Z7 Steel	KUD 0403	4	3	6	50	1 2 3 5	7	■	1
A10030605609	HFD 0605.06	Z9 Alu	KUD 0605	6	5	6	50		6 8	■	1
A10030605620	HFD 0605.06	Z42 Inox/Steel	KUD 0605	6	5	6	50	1 2 3 4		■	1
A10030605621	HFD 0605.06	Cast	KUD 0605	6	5	6	50		5	■	1
A10030606305	HFD 0605.03	Z5	KUD 0605	6	5	3	35	1 2 3 4	7	■	1
A10030606308	HFD 0605.03	Z7 Steel	KUD 0605	6	5	3	35	1 2 3 5	7	■	1
A10030606603	HFD 0605.06	Z3	KUD 0605	6	5	6	50	1 2 3 4	7	■	1
A10030606604	HFD 0605.06	Z4	KUD 0605	6	5	6	50	2 3 4	7 8	■	1
A10030606605	HFD 0605.06	Z5	KUD 0605	6	5	6	50	1 2 3 4	7	■	1
A10030606608	HFD 0605.06	Z7 Steel	KUD 0605	6	5	6	50	1 2 3 5	7	■	1
A10030807620	HFD 0807.06	Z42 Inox/Steel	KUD 0807	8	7	6	47	1 2 3 4		■	1
A10030807621	HFD 0807.06	Cast	KUD 0807	8	7	6	47		5	■	1
A10030808603	HFD 0807.06	Z3	KUD 0807	8	7	6	47	1 2 3 4	7	■	1
A10030808604	HFD 0807.06	Z4	KUD 0807	8	7	6	47	2 3 4	7 8	■	1
A10030808605	HFD 0807.06	Z5	KUD 0807	8	7	6	47	1 2 3 4	7	■	1
A10030808608	HFD 0807.06	Z7 Steel	KUD 0807	8	7	6	47	1 2 3 5	7	■	1
A10031009620	HFD 1009.06	Z42 Inox/Steel	KUD 1009	10	9	6	49	1 2 3 4		■	1
A10031009621	HFD 1009.06	Cast	KUD 1009	10	9	6	49		5	■	1
A10031010603	HFD 1009.06	Z3	KUD 1009	10	9	6	49	1 2 3 4	7	■	1
A10031010604	HFD 1009.06	Z4	KUD 1009	10	9	6	49	2 3 4	7 8	■	1
A10031010605	HFD 1009.06	Z5	KUD 1009	10	9	6	49	1 2 3 4	7	■	1
A10031010608	HFD 1009.06	Z7 Steel	KUD 1009	10	9	6	49	1 2 3 5	7	■	1
A10031210620	HFD 1210.06	Z42 Inox/Steel	KUD 1210	12	10	6	51	1 2 3 4		■	1
A10031210621	HFD 1210.06	Cast	KUD 1210	12	10	6	51		5	■	1
A10031210808	HFD 1210.08	Z7 Steel	KUD 1210	12	10	8	51	1 2 3 5	7	■	1
A10031212603	HFD 1210.06	Z3	KUD 1210	12	10	6	51	1 2 3 4	7	■	1
A10031212604	HFD 1210.06	Z4	KUD 1210	12	10	6	51	2 3 4	7 8	■	1
A10031212605	HFD 1210.06	Z5	KUD 1210	12	10	6	51	1 2 3 4	7	■	1
A10031212608	HFD 1210.06	Z7 Steel	KUD 1210	12	10	6	51	1 2 3 5	7	■	1
A10031212609	HFD 1210.06	Z9 Alu	KUD 1210	12	10	6	50		6 8	■	1
A10031212804	HFD 1210.08	Z4	KUD 1210	12	10	8	51	2 3 4	7 8	■	1
A10031616603	HFD 1614.06	Z3	KUD 1614	16	14	6	54	1 2 3 4	7	■	1
A10031616604	HFD 1614.06	Z4	KUD 1614	16	14	6	54	2 3 4	7 8	■	1
A10031616608	HFD 1614.06	Z7 Steel	KUD 1614	16	14	6	54	1 2 3 5	7	■	1
A10031616609	HFD 1614.06	Z9 Alu	KUD 1614	16	14	6	54		6 8	■	1
A10031616803	HFD 1614.08	Z3	KUD 1614	16	14	8	54	1 2 3 4	7	■	1

Shape D, Spherical

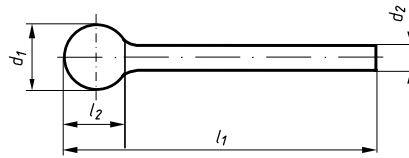

Ordering example: A10030303302

Further dimensions, cuts and shank lengths on request

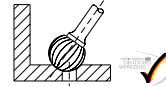
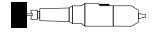

PG 1

Product number	Description	Cut	similar to DIN 8033	d ₁ mm	l ₂ mm	d ₂ mm	l ₁ mm	recommended for Information on page 438		
A10031616809	HFD 1614.08	Z9 Alu	KUD 1614	16	14	8	54	6 8	■	1
A10032020603	HFD 2018.06	Z3	KUD 2018	20	18	6	58	1 2 3 4 7	■	1
A10032020608	HFD 2018.06	Z7 Steel	KUD 2018	20	18	6	58	1 2 3 5 7	■	1
A10032020803	HFD 2018.08	Z3	KUD 2018	20	18	8	58	1 2 3 4 7	■	1

Shape D, Spherical BASE-X

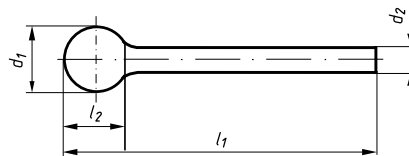

Ordering example: A10030403322

Further dimensions, cuts and shank lengths on request

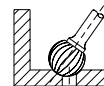

PG 1

Product number	Description	Cut	similar to DIN 8033	d ₁ mm	l ₂ mm	d ₂ mm	l ₁ mm	recommended for Information on page 438		
A10030403322	HFD 0403.03 BASE-X	ZX	KUD 0403	4	3	3	34	1 2 3 4 5 6 7	■	10
A10030605322	HFD 0605.03 BASE-X	ZX	KUD 0605	6	5	3	35	1 2 3 4 5 6 7	■	10
A10030807622	HFD 0807.06 BASE-X	ZX	KUD 0807	8	7	6	47	1 2 3 4 5 6 7	■	10
A10030807622150	HFD 0807.06 BASE-X	ZX	KUD 0807	8	7	6	157	1 2 3 4 5 6 7	■	10
A10031009622	HFD 1009.06 BASE-X	ZX	KUD 1009	10	9	6	49	1 2 3 4 5 6 7	■	10
A10031009622150	HFD 1009.06 BASE-X	ZX	KUD 1009	10	9	6	159	1 2 3 4 5 6 7	■	10
A5003100962214	HFD 1009.06 BASE-X	ZX	KUD 1009	10	9	1/4"	49	1 2 3 4 5 6 7	■	10
A10031210622	HFD 1210.06 BASE-X	ZX	KUD 1210	12	10	6	51	1 2 3 4 5 6 7	■	5
A5003121062214	HFD 1210.06 BASE-X	ZX	KUD 1210	12	10	1/4"	51	1 2 3 4 5 6 7	■	5

Shape E, Oval



Ordering example: A10060307303

Further dimensions, cuts and shank lengths on request

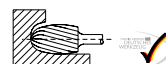
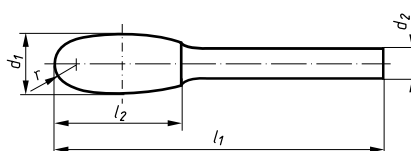

PG 1

Product number	Description	Cut	similar to DIN 8033	d ₁ mm	l ₂ mm	d ₂ mm	l ₁ mm	recommended for	Information on page 438		
A10060307303	HFE 0307.03	Z3	TRE 0307	3	7	3	40	1 2 3 4	7	■	1
A10060307305	HFE 0307.03	Z5	TRE 0307	3	7	3	40	1 2 3 4	7	■	1
A10060307308	HFE 0307.03	Z7 Steel	TRE 0307	3	7	3	40	1 2 3 5	7	■	1
A10060610305	HFE 0610.03	Z5	TRE 0610	6	10	3	40	1 2 3 4	7	■	1
A10060610308	HFE 0610.03	Z7 Steel	TRE 0610	6	10	3	40	1 2 3 5	7	■	1
A10060610603	HFE 0610.06	Z3	TRE 0610	6	10	6	50	1 2 3 4	7	■	1
A10060610604	HFE 0610.06	Z4	TRE 0610	6	10	6	50	2 3 4	7 8	■	1
A10060610608	HFE 0610.06	Z7 Steel	TRE 0610	6	10	6	50	1 2 3 5	7	■	1
A10060610621	HFE 0610.06	Cast	TRE 0610	6	10	6	50	5		■	1
A10060813603	HFE 0813.06	Z3	TRE 0813	8	13	6	53	1 2 3 4	7	■	1
A10060813604	HFE 0813.06	Z4	TRE 0813	8	13	6	53	2 3 4	7 8	■	1
A10060813608	HFE 0813.06	Z7 Steel	TRE 0813	8	13	6	53	1 2 3 5	7	■	1
A10060813621	HFE 0813.06	Cast	TRE 0813	8	13	6	53	5		■	1
A10061016621	HFE 1016.06	Cast	TRE 1016	10	16	6	56	5		■	1
A10061220603	HFE 1220.06	Z3	TRE 1220	12	20	6	60	1 2 3 4	7	■	1
A10061220604	HFE 1220.06	Z4	TRE 1220	12	20	6	60	2 3 4	7 8	■	1
A10061220608	HFE 1220.06	Z7 Steel	TRE 1220	12	20	6	60	1 2 3 5	7	■	1
A10061220621	HFE 1220.06	Cast	TRE 1220	12	20	6	60	5		■	1
A10061225803	HFE 1225.08	Z3	TRE 1225	12	25	8	65	1 2 3 4	7	■	1
A10061225809	HFE 1225.08	Z9 Alu	TRE 1225	12	25	8	65		6 8	■	1
A10061625608	HFE 1625.06	Z7 Steel	TRE 1625	16	25	6	65	1 2 3 5	7	■	1
A10061625803	HFE 1625.08	Z3	TRE 1625	16	25	8	65	1 2 3 4	7	■	1
A10061625809	HFE 1625.08	Z9 Alu	TRE 1625	16	25	8	65		6 8	■	1

Shape F, Arch round nose

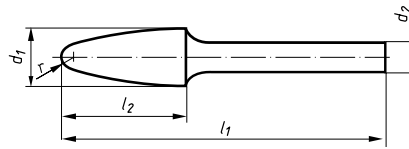

Ordering example: A10100307303

Further dimensions, cuts and shank lengths on request

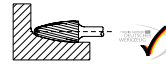
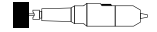

PG 1

Product number	Description	Cut	similar to DIN 8033	d ₁ mm	l ₂ mm	d ₂ mm	l ₁ mm	recommended for Information on page 438		
A10100307303	HFF 0307.03	Z3	RBF 0307	3	7	3	40	① ② ③ ④	⑦	■ 1
A10100307304	HFF 0307.03	Z4	RBF 0307	3	7	3	40	② ③ ④	⑦ ⑧	■ 1
A10100307305	HFF 0307.03	Z5	RBF 0307	3	7	3	40	① ② ③ ④	⑦	■ 1
A10100313305	HFF 0313.03	Z5	RBF 0313	3	13	3	40	① ② ③ ④	⑦	■ 1
A10100313308	HFF 0313.03	Z7 Steel	RBF 0313	3	13	3	40	① ② ③	⑤ ⑦	■ 1
A10100313309	HFF 0313.03	Z9 Alu	RBF 0313	3	13	3	40		⑥ ⑧	■ 1
A10100613305	HFF 0613.03	Z5	RBF 0613	6	13	3	43	① ② ③ ④	⑦	■ 1
A10100613308	HFF 0613.03	Z7 Steel	RBF 0613	6	13	3	43	① ② ③	⑤ ⑦	■ 1
A10100618603	HFF 0618.06	Z3	RBF 0618	6	18	6	50	① ② ③ ④	⑦	■ 1
A10100618604	HFF 0618.06	Z4	RBF 0618	6	18	6	50	② ③ ④	⑦ ⑧	■ 1
A10100618605	HFF 0618.06	Z5	RBF 0618	6	18	6	50	① ② ③ ④	⑦	■ 1
A10100618608	HFF 0618.06	Z7 Steel	RBF 0618	6	18	6	50	① ② ③	⑤ ⑦	■ 1
A10100618609	HFF 0618.06	Z9 Alu	RBF 0618	6	18	6	50		⑥ ⑧	■ 1
A10100618620	HFF 0618.06	Z42 Inox/Steel	RBF 0618	6	18	6	50	① ② ③ ④		■ 1
A10100618621	HFF 0618.06	Cast	RBF 0618	6	18	6	50		⑤	■ 1
A10100820603	HFF 0820.06	Z3	---	8	20	6	60	① ② ③ ④	⑦	■ 1
A10100820608	HFF 0820.06	Z7 Steel	---	8	20	6	60	① ② ③	⑤ ⑦	■ 1
A10100820620	HFF 0820.06	Z42 Inox/Steel	---	8	20	6	60	① ② ③ ④		■ 1
A10100820621	HFF 0820.06	Cast	---	8	20	6	60		⑤	■ 1
A10101020603	HFF 1020.06	Z3	RBF 1020	10	20	6	60	① ② ③ ④	⑦	■ 1
A10101020604	HFF 1020.06	Z4	RBF 1020	10	20	6	60	② ③ ④	⑦ ⑧	■ 1
A10101020606	HFF 1020.06	Z6	RBF 1020	10	20	6	60	② ③ ④	⑦ ⑧	■ 1
A10101020608	HFF 1020.06	Z7 Steel	RBF 1020	10	20	6	60	① ② ③	⑤ ⑦	■ 1
A10101020620	HFF 1020.06	Z42 Inox/Steel	RBF 1020	10	20	6	60	① ② ③ ④		■ 1
A10101020621	HFF 1020.06	Cast	RBF 1020	10	20	6	60		⑤	■ 1
A10101225601	HFF 1225.06	Z1	RBF 1225	12	25	6	65		⑥ ⑧	■ 1
A10101225603	HFF 1225.06	Z3	RBF 1225	12	25	6	65	① ② ③ ④	⑦	■ 1
A10101225604	HFF 1225.06	Z4	RBF 1225	12	25	6	65	② ③ ④	⑦ ⑧	■ 1
A10101225608	HFF 1225.06	Z7 Steel	RBF 1225	12	25	6	65	① ② ③	⑤ ⑦	■ 1
A10101225609	HFF 1225.06	Z9 Alu	RBF 1225	12	25	6	65		⑥ ⑧	■ 1
A10101225620	HFF 1225.06	Z42 Inox/Steel	RBF 1225	12	25	6	65	① ② ③ ④		■ 1
A10101225621	HFF 1225.06	Cast	RBF 1225	12	25	6	65		⑤	■ 1
A10101225803	HFF 1225.08	Z3	RBF 1225	12	25	8	65	① ② ③ ④	⑦	■ 1
A10101225808	HFF 1225.08	Z7 Steel	RBF 1225	12	25	8	65	① ② ③	⑤ ⑦	■ 1
A10101225809	HFF 1225.08	Z9 Alu	RBF 1225	12	25	8	65		⑥ ⑧	■ 1
A10101230603	HFF 1230.06	Z3	RBF 1230	12	30	6	70	① ② ③ ④	⑦	■ 1
A10101230608	HFF 1230.06	Z7 Steel	RBF 1230	12	30	6	70	① ② ③	⑤ ⑦	■ 1

Shape F, Arch round nose



Ordering example: A10100307303

Further dimensions, cuts and shank lengths on request

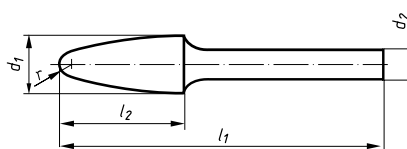

PG 1

Product number	Description	Cut	similar to DIN 8033	d ₁ mm	l ₂ mm	d ₂ mm	l ₁ mm	recommended for Information on page 438		
A10101630608	HFF 1630.06	Z7 Steel	RBF 1630	16	30	6	70	① ② ③ ⑤ ⑦	■	1
A10101630609	HFF 1630.06	Z9 Alu	RBF 1630	16	30	6	70	⑥ ⑧	■	1
A10101630803	HFF 1630.08	Z3	RBF 1630	16	30	8	70	① ② ③ ④ ⑦	■	1
A10101630809	HFF 1630.08	Z9 Alu	RBF 1630	16	30	8	70	⑥ ⑧	■	1

Shape F, Arch round nose BASE-X



Ordering example: A10100313322

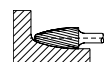
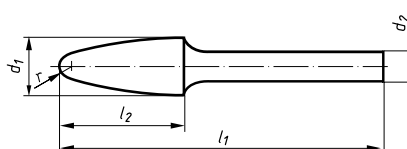

PG 1

Product number	Description	Cut	similar to DIN 8033	d ₁ mm	l ₂ mm	d ₂ mm	l ₁ mm	recommended for Information on page 438		
A10100313322	HFF 0313.03 BASE-X	ZX	RBF 0313	3	13	3	40	① ② ③ ④ ⑤ ⑥ ⑦	■	10
A10100618622	HFF 0618.06 BASE-X	ZX	RBF 0618	6	18	6	50	① ② ③ ④ ⑤ ⑥ ⑦	■	10
A10100820622	HFF 0820.06 BASE-X	ZX	—	8	20	6	60	① ② ③ ④ ⑤ ⑥ ⑦	■	10
A10100820622150	HFF 0820.06 BASE-X	ZX	—	8	20	6	170	① ② ③ ④ ⑤ ⑥ ⑦	■	10
A5010082062214	HFF 0820.06 BASE-X	ZX	—	8	20	1/4"	60	① ② ③ ④ ⑤ ⑥ ⑦	■	10
A10101020622	HFF 1020.06 BASE-X	ZX	RBF 1020	10	20	6	60	① ② ③ ④ ⑤ ⑥ ⑦	■	10
A5010102062214	HFF 1020.06 BASE-X	ZX	RBF 1020	10	20	1/4"	60	① ② ③ ④ ⑤ ⑥ ⑦	■	10
A10101225622	HFF 1225.06 BASE-X	ZX	RBF 1225	12	25	6	65	① ② ③ ④ ⑤ ⑥ ⑦	■	5
A5010122562214	HFF 1225.06 BASE-X	ZX	RBF 1225	12	25	1/4"	65	① ② ③ ④ ⑤ ⑥ ⑦	■	5
A10101225622150	HFF 1225.06 BASE-X	ZX	RBF 1225	12	25	6	175	① ② ③ ④ ⑤ ⑥ ⑦	■	5

Shape G, Arch pointed nose



Ordering example: A10040307305

Further dimensions, cuts and shank lengths on request

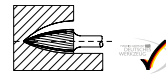
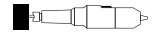

PG 1

Product number	Description	Cut	similar to DIN 8033	d ₁ mm	l ₂ mm	d ₂ mm	l ₁ mm	recommended for	Information on page 438		
A10040307305	HFG 0307.03	Z5	SPG 0307	3	7	3	40	1 2 3 4	7	■	1
A10040307308	HFG 0307.03	Z7 Steel	SPG 0307	3	7	3	40	1 2 3 5	7	■	1
A10040313303	HFG 0313.03	Z3	SPG 0313	3	13	3	40	1 2 3 4	7	■	1
A10040313304	HFG 0313.03	Z4	SPG 0313	3	13	3	40	2 3 4	7 8	■	1
A10040313305	HFG 0313.03	Z5	SPG 0313	3	13	3	40	1 2 3 4	7	■	1
A10040313308	HFG 0313.03	Z7 Steel	SPG 0313	3	13	3	40	1 2 3 5	7	■	1
A10040313309	HFG 0313.03	Z9 Alu	SPG 0313	3	13	3	40	6	8	■	1
A10040613305	HFG 0613.03	Z5	SPG 0613	6	13	3	43	1 2 3 4	7	■	1
A10040613308	HFG 0613.03	Z7 Steel	SPG 0613	6	13	3	43	1 2 3 5	7	■	1
A10040618601	HFG 0618.06	Z1	SPG 0618	6	18	6	50	6	8	■	1
A10040618602	HFG 0618.06	Z2	SPG 0618	6	18	6	50	1 5 6	8	■	1
A10040618603	HFG 0618.06	Z3	SPG 0618	6	18	6	50	1 2 3 4	7	■	1
A10040618604	HFG 0618.06	Z4	SPG 0618	6	18	6	50	2 3 4	7 8	■	1
A10040618605	HFG 0618.06	Z5	SPG 0618	6	18	6	50	1 2 3 4	7	■	1
A10040618608	HFG 0618.06	Z7 Steel	SPG 0618	6	18	6	50	1 2 3 5	7	■	1
A10040618620	HFG 0618.06	Z42 Inox/Steel	SPG 0618	6	18	6	50	1 2 3 4		■	1
A10040618621	HFG 0618.06	Cast	SPG 0618	6	18	6	50	5		■	1
A10040820603	HFG 0820.06	Z3	---	8	20	6	60	1 2 3 4	7	■	1
A10040820608	HFG 0820.06	Z7 Steel	---	8	20	6	60	1 2 3 5	7	■	1
A10040820620	HFG 0820.06	Z42 Inox/Steel	---	8	20	6	60	1 2 3 4		■	1
A10040820621	HFG 0820.06	Cast	---	8	20	6	60	5		■	1
A10041020603	HFG 1020.06	Z3	SPG 1020	10	20	6	60	1 2 3 4	7	■	1
A10041020604	HFG 1020.06	Z4	SPG 1020	10	20	6	60	2 3 4	7 8	■	1
A10041020605	HFG 1020.06	Z5	SPG 1020	10	20	6	60	1 2 3 4	7	■	1
A10041020608	HFG 1020.06	Z7 Steel	SPG 1020	10	20	6	60	1 2 3 5	7	■	1
A10041020620	HFG 1020.06	Z42 Inox/Steel	SPG 1020	10	20	6	60	1 2 3 4		■	1
A10041020621	HFG 1020.06	Cast	SPG 1020	10	20	6	60	5		■	1
A10041220603	HFG 1220.06	Z3	SPG 1220	12	20	6	60	1 2 3 4	7	■	1
A10041220608	HFG 1220.06	Z7 Steel	SPG 1220	12	20	6	60	1 2 3 5	7	■	1
A10041225602	HFG 1225.06	Z2	SPG 1225	12	25	6	65	1 5 6	8	■	1
A10041225603	HFG 1225.06	Z3	SPG 1225	12	25	6	65	1 2 3 4	7	■	1
A10041225604	HFG 1225.06	Z4	SPG 1225	12	25	6	65	2 3 4	7 8	■	1
A10041225608	HFG 1225.06	Z7 Steel	SPG 1225	12	25	6	65	1 2 3 5	7	■	1
A10041225620	HFG 1225.06	Z42 Inox/Steel	SPG 1225	12	25	6	65	1 2 3 4		■	1
A10041225621	HFG 1225.06	Cast	SPG 1225	12	25	6	65	5		■	1
A10041225803	HFG 1225.08	Z3	SPG 1225	12	25	8	65	1 2 3 4	7	■	1
A10041230602	HFG 1230.06	Z2	SPG 1230	12	30	6	70	1 5 6	8	■	1

Shape G, Arch pointed nose



Ordering example: A10040307305

Further dimensions, cuts and shank lengths on request

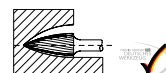
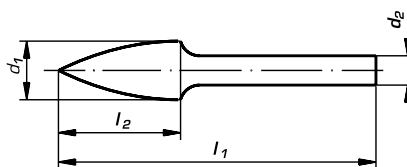

PG 1

Product number	Description	Cut	similar to DIN 8033	d ₁ mm	l ₂ mm	d ₂ mm	l ₁ mm	recommended for Information on page 438		
A10041230603	HFG 1230.06	Z3	SPG 1230	12	30	6	70	① ② ③ ④ ⑦	■	1
A10041230604	HFG 1230.06	Z4	SPG 1230	12	30	6	70	② ③ ④ ⑦ ⑧	■	1
A10041230605	HFG 1230.06	Z5	SPG 1230	12	30	6	70	① ② ③ ④ ⑦	■	1
A10041230608	HFG 1230.06	Z7 Steel	SPG 1230	12	30	6	70	① ② ③ ⑤ ⑦	■	1
A10041630603	HFG 1630.06	Z3	SPG 1630	16	30	6	70	① ② ③ ④ ⑦	■	1
A10041630604	HFG 1630.06	Z4	SPG 1630	16	30	6	70	② ③ ④ ⑦ ⑧	■	1
A10041630608	HFG 1630.06	Z7 Steel	SPG 1630	16	30	6	70	① ② ③ ⑤ ⑦	■	1
A10041630803	HFG 1630.08	Z3	SPG 1630	16	30	8	70	① ② ③ ④ ⑦	■	1

Shape G, Arch pointed nose BASE-X



Ordering example: A10040313322

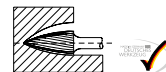
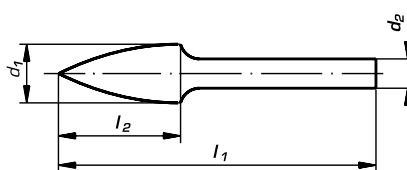

PG 1

Product number	Description	Cut	similar to DIN 8033	d ₁ mm	l ₂ mm	d ₂ mm	l ₁ mm	recommended for Information on page 438		
A10040313322	HFG 0313.03 BASE-X	ZX	SPG 0313	3	13	3	40	① ② ③ ④ ⑤ ⑥ ⑦	■	10
A10040613322	HFG 0613.03 BASE-X	ZX	SPG 0613	6	13	3	43	① ② ③ ④ ⑤ ⑥ ⑦	■	10
A10040820622	HFG 0820.06 BASE-X	ZX	SPG 0820	8	20	6	60	① ② ③ ④ ⑤ ⑥ ⑦	■	10
A5004082062214	HFG 0820.06 BASE-X	ZX	SPG 8020	8	20	1/4"	60	① ② ③ ④ ⑤ ⑥ ⑦	■	10
A10041020622	HFG 1020.06 BASE-X	ZX	SPG 1020	10	20	6	60	① ② ③ ④ ⑤ ⑥ ⑦	■	10
A5004102062214	HFG 1020.06 BASE-X	ZX	SPG 1020	10	20	1/4"	60	① ② ③ ④ ⑤ ⑥ ⑦	■	10
A10041225622	HFG 1225.06 BASE-X	ZX	SPG 1225	12	25	6	65	① ② ③ ④ ⑤ ⑥ ⑦	■	5
A5004122562214	HFG 1225.06 BASE-X	ZX	SPG 1225	12	25	1/4"	65	① ② ③ ④ ⑤ ⑥ ⑦	■	5
A10041230622	HFG 1230.06 BASE-X	ZX	SPG 1230	12	30	6	65	① ② ③ ④ ⑤ ⑥ ⑦	■	5
A5004123062214	HFG 1230.06 BASE-X	ZX	SPG 1230	12	30	1/4"	70	① ② ③ ④ ⑤ ⑥ ⑦	■	5

Shape H, Flame

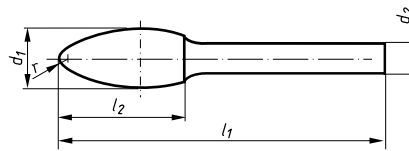

Ordering example: A10090307305

Further dimensions, cuts and shank lengths on request

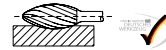
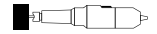

PG 1

Product number	Description	Cut	d ₁ mm	l ₂ mm	d ₂ mm	l ₁ mm	recommended for Information on page 438		
A10090307305	HFH 0307.03	Z5	3	7	3	40	① ② ③ ④ ⑦	■	1
A10090613301	HFH 0613.03	Z1	6	13	3	43	⑥ ⑧	■	1
A10090613302	HFH 0613.03	Z2	6	13	3	43	① ⑤ ⑥ ⑧	■	1
A10090613303	HFH 0613.03	Z3	6	13	3	43	① ② ③ ④ ⑦	■	1
A10090613304	HFH 0613.03	Z4	6	13	3	43	② ③ ④ ⑦ ⑧	■	1
A10090613305	HFH 0613.03	Z5	6	13	3	43	① ② ③ ④ ⑦	■	1
A10090613308	HFH 0613.03	Z7 Steel	6	13	3	43	① ② ③ ⑤ ⑦	■	1
A10090820602	HFH 0820.06	Z2	8	20	6	60	① ⑤ ⑥ ⑧	■	1
A10090820603	HFH 0820.06	Z3	8	20	6	60	① ② ③ ④ ⑦	■	1
A10090820604	HFH 0820.06	Z4	8	20	6	60	② ③ ④ ⑦ ⑧	■	1
A10090820608	HFH 0820.06	Z7 Steel	8	20	6	60	① ② ③ ⑤ ⑦	■	1
A10091230603	HFH 1230.06	Z3	12	30	6	70	① ② ③ ④ ⑦	■	1
A10091230604	HFH 1230.06	Z4	12	30	6	70	② ③ ④ ⑦ ⑧	■	1
A10091230608	HFH 1230.06	Z7 Steel	12	30	6	70	① ② ③ ⑤ ⑦	■	1
A10091230803	HFH 1230.08	Z3	12	30	8	70	① ② ③ ④ ⑦	■	1
A10091635608	HFH 1635.06	Z7 Steel	16	35	6	75	① ② ③ ⑤ ⑦	■	1

Shape I, Internal burr with multi-purpose cut

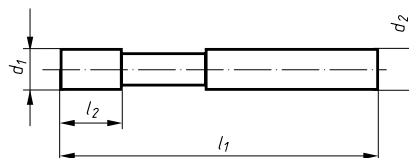

Ordering example: A10010204300

Further dimensions, cuts and shank lengths on request

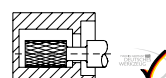

PG 1

Product number	Description	Cut	d ₁ mm	l ₂ mm	d ₂ mm	l ₁ mm	recommended for Information on page 438		
A10010204300	HFI 0204.03	ZI	2,5	4	3	40	③ ④ ⑦	■	1
A10010408300	HFI 0408.03	ZI	4	8	3	50	③ ④ ⑦	■	1
A10010810600	HFI 0810.06	ZI	8	10	6	65	③ ④ ⑦	■	1

Shape J, Pointed nose



Ordering example: A10080660603

Further dimensions, cuts and shank lengths on request

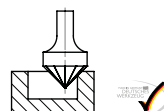

PG 1

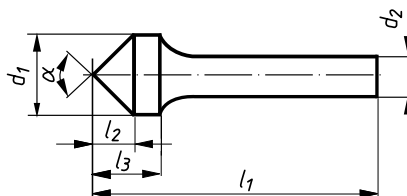

Product number	Description	Cut	similar to DIN 8033	d1 mm	l2 mm	l3 mm	d2 mm	l1 mm	α	recommended for	Information on page 438	PG 1	
A10080660603	HFJ 0605.06	Z3	KSJ 0605	6	5	-	6	50	60°	1 2 3 4	7	■	1
A10081060603	HFJ 1013.06	Z3	KSJ 1008	10	9	13	6	53	60°	1 2 3 4	7	■	1
A10081090603	HFJ 1010.06	Z3	KSK 1005	10	5	10	6	50	90°	1 2 3 4	7	■	1
A10081660603	HFJ 1616.06	Z3	KSJ 1613	16	14	16	6	56	60°	1 2 3 4	7	■	1
A10081690603	HFJ 1613.06	Z3	KSK 1608	16	8	13	6	53	90°	1 2 3 4	7	■	1
A10081690803	HFJ 1613.08	Z3	KSK 1608	16	8	13	8	53	90°	1 2 3 4	7	■	1

Shape L, Conical round nose



Ordering example: A10070820603

Further dimensions, cuts and shank lengths on request

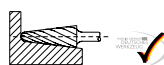

PG 1

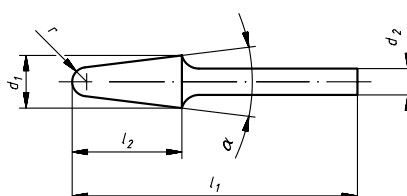

Product number	Description	Cut	similar to DIN 8033	d1 mm	l2 mm	d2 mm	l1 mm	r mm	α	recommended for	Information on page 438	PG 1	
A10070820603	HFL 0820.06	Z3	---	8	20	6	60	1,5	14°	1 2 3 4	7	■	1
A10070820608	HFL 0820.06	Z7 Steel	---	8	20	6	60	1,5	14°	1 2 3 5	7	■	1
A10070820609	HFL 0820.06	Z9 Alu	---	8	20	6	60	1,5	14°		6 8	■	1
A10071020603	HFL 1020.06	Z3	KEL 1020	10	20	6	60	2,9	14°	1 2 3 4	7	■	1
A10071020608	HFL 1020.06	Z7 Steel	KEL 1020	10	20	6	60	2,9	14°	1 2 3 5	7	■	1
A10071020609	HFL 1020.06	Z9 Alu	KEL 1020	10	20	6	60	2,9	14°		6 8	■	1
A10071225603	HFL 1225.06	Z3	KEL 1225	12	25	6	65	3,3	14°	1 2 3 4	7	■	1
A10071225604	HFL 1225.06	Z4	KEL 1225	12	25	6	65	3,3	14°	2 3 4	7 8	■	1
A10071225608	HFL 1225.06	Z7 Steel	KEL 1225	12	25	6	65	3,3	14°	1 2 3 5	7	■	1
A10071225609	HFL 1225.06	Z9 Alu	KEL 1225	12	25	6	65	3,3	14°		6 8	■	1
A10071225803	HFL 1225.08	Z3	KEL 1225	12	25	8	65	3,3	14°	1 2 3 4	7	■	1
A10071230601	HFL 1230.06	Z1	KEL 1230	12	30	6	70	2,6	14°		6 8	■	1
A10071230603	HFL 1230.06	Z3	KEL 1230	12	30	6	70	2,6	14°	1 2 3 4	7	■	1
A10071230604	HFL 1230.06	Z4	KEL 1230	12	30	6	70	2,6	14°	2 3 4	7 8	■	1

Shape L, Conical round nose

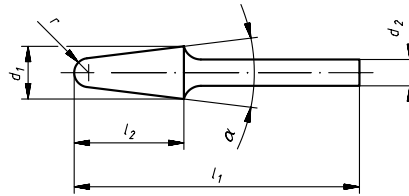

Ordering example: A10070820603

Further dimensions, cuts and shank lengths on request

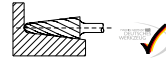
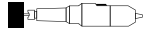

PG 1

Product number	Description	Cut	similar to DIN 8033	d ₁ mm	l ₂ mm	d ₂ mm	l ₁ mm	r mm	α	recommended for Information on page 438		
A10071230605	HFL 1230.06	Z5	KEL 1230	12	30	6	70	2,6	14°	① ② ③ ④ ⑦	■	1
A10071230608	HFL 1230.06	Z7 Steel	KEL 1230	12	30	6	70	2,6	14°	① ② ③ ⑤ ⑦	■	1
A10071230609	HFL 1230.06	Z9 Alu	KEL 1230	12	30	6	70	2,6	14°	⑥ ⑧	■	1
A10071230804	HFL 1230.08	Z4	KEL 1230	12	30	8	70	2,6	14°	② ③ ④ ⑦ ⑧	■	1
A10071230809	HFL 1230.08	Z9 Alu	KEL 1230	12	30	8	70	2,6	14°	⑥ ⑧	■	1
A10071630603	HFL 1630.06	Z3	KEL 1630	16	30	6	70	4,8	14°	① ② ③ ④ ⑦	■	1
A10071630608	HFL 1630.06	Z7 Steel	KEL 1630	16	30	6	70	4,8	14°	① ② ③ ⑤ ⑦	■	1
A10072040809	HFL 2040.08	Z9 Alu	KEL 2040	20	40	8	80	5,5	14°	⑥ ⑧	■	1

Shape L, Conical round nose BASE-X

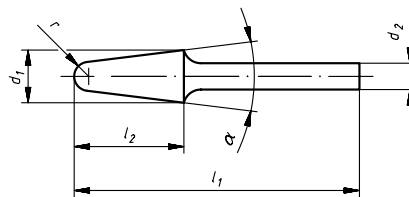

Ordering example: A10071230622

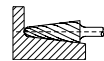

PG 1

Product number	Description	Cut	similar to DIN 8033	d ₁ mm	l ₂ mm	d ₂ mm	l ₁ mm	r mm	α	recommended for Information on page 438		
A10071230622	HFL 1230.06 BASE-X	ZX	KEL 1230	12	30	6	70	2,6	14°	① ② ③ ④ ⑤ ⑥ ⑦	■	5
A5007123062214	HFL 1230.06 BASE-X	ZX	KEL 1230	12	30	1/4"	70	2,6	14°	① ② ③ ④ ⑤ ⑥ ⑦	■	5

Shape M, Conical pointed nose

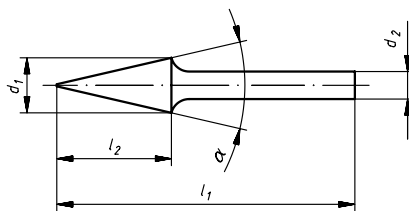

Ordering example: A10050307303

Further dimensions, cuts and shank lengths on request

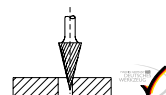

PG 1

Product number	Description	Cut	similar to DIN 8033	d ₁ mm	l ₂ mm	d ₂ mm	l ₁ mm	α	recommended for Information on page 438		
A10050307303	HFM 0307.03	Z3	SKM 0307	3	7	3	40	22°	① ② ③ ④	⑦	■ 1
A10050307305	HFM 0307.03	Z5	SKM 0307	3	7	3	40	22°	① ② ③ ④	⑦	■ 1
A10050307308	HFM 0307.03	Z7 Steel	SKM 0307	3	7	3	40	22°	① ② ③ ⑤	⑦	■ 1
A10050311305	HFM 0311.03	Z5	SKM 0311	3	11	3	40	14°	① ② ③ ④	⑦	■ 1
A10050311308	HFM 0311.03	Z7 Steel	SKM 0311	3	11	3	40	14°	① ② ③ ⑤	⑦	■ 1
A10050613305	HFM 0613.03	Z5	SKM 0613	6	13	3	43	25°	① ② ③ ④	⑦	■ 1
A10050613308	HFM 0613.03	Z7 Steel	SKM 0613	6	13	3	43	25°	① ② ③ ⑤	⑦	■ 1
A10050618603	HFM 0618.06	Z3	SKM 0618	6	18	6	50	16°	① ② ③ ④	⑦	■ 1
A10050618604	HFM 0618.06	Z4	SKM 0618	6	18	6	50	16°	② ③ ④	⑦ ⑧	■ 1
A10050618605	HFM 0618.06	Z5	SKM 0618	6	18	6	50	16°	① ② ③ ④	⑦	■ 1
A10050618608	HFM 0618.06	Z7 Steel	SKM 0618	6	18	6	50	16°	① ② ③ ⑤	⑦	■ 1
A10050618609	HFM 0618.06	Z9 Alu	SKM 0618	6	18	6	50	16°	⑥	⑧	■ 1
A10050618620	HFM 0618.06	Z42 Inox/Steel	SKM 0618	6	18	6	50	16°	① ② ③ ④		■ 1
A10050820603	HFM 0820.06	Z3	---	8	20	6	60	21°	① ② ③ ④	⑦	■ 1
A10050820608	HFM 0820.06	Z7 Steel	---	8	20	6	60	21°	① ② ③ ⑤	⑦	■ 1
A10050820620	HFM 0820.06	Z42 Inox/Steel	---	8	20	6	60	21°	① ② ③ ④		■ 1
A10051020603	HFM 1020.06	Z3	SKM 1020	10	20	6	60	27°	① ② ③ ④	⑦	■ 1
A10051020604	HFM 1020.06	Z4	SKM 1020	10	20	6	60	27°	② ③ ④	⑦ ⑧	■ 1
A10051020608	HFM 1020.06	Z7 Steel	SKM 1020	10	20	6	60	27°	① ② ③ ⑤	⑦	■ 1
A10051020620	HFM 1020.06	Z42 Inox/Steel	SKM 1020	10	20	6	60	27°	① ② ③ ④		■ 1
A10051020803	HFM 1020.08	Z3	---	10	20	8	60	27°	① ② ③ ④	⑦	■ 1
A10051225601	HFM 1225.06	Z1	SKM 1225	12	25	6	65	26°		⑥ ⑧	■ 1
A10051225603	HFM 1225.06	Z3	SKM 1225	12	25	6	65	26°	① ② ③ ④	⑦	■ 1
A10051225604	HFM 1225.06	Z4	SKM 1225	12	25	6	65	26°	② ③ ④	⑦ ⑧	■ 1
A10051225608	HFM 1225.06	Z7 Steel	SKM 1225	12	25	6	65	26°	① ② ③ ⑤	⑦	■ 1
A10051225620	HFM 1225.06	Z42 Inox/Steel	SKM 1225	12	25	6	65	26°	① ② ③ ④		■ 1
A10051225803	HFM 1225.08	Z3	SKM 1225	12	25	8	65	26°	① ② ③ ④	⑦	■ 1

Shape M, Conical pointed nose BASE-X



Ordering example: A10050311322

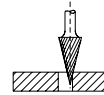
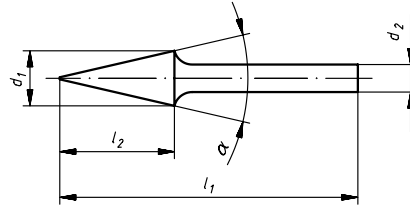
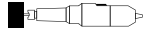

PG 1

Product number	Description	Cut	similar to DIN 8033	d ₁ mm	l ₂ mm	d ₂ mm	l ₁ mm	α	recommended for Information on page 438		
A10050311322	HFM 0311.03 BASE-X	ZX	SKM 0311	3	11	3	40	14°	① ② ③ ④ ⑤ ⑥ ⑦	■	10
A10050618622	HFM 0618.06 BASE-X	ZX	SKM 0618	6	18	6	50	16°	① ② ③ ④ ⑤ ⑥ ⑦	■	10
A5005061862214	HFM 0618.06 BASE-X	ZX	SKM 0618	6	18	1/4"	50	16°	① ② ③ ④ ⑤ ⑥ ⑦	■	10
A10051020622	HFM 1020.06 BASE-X	ZX	SKM 1020	10	20	6	60	27°	① ② ③ ④ ⑤ ⑥ ⑦	■	10
A5005102062214	HFM 1020.06 BASE-X	ZX	SKM 1020	10	20	1/4"	60	27°	① ② ③ ④ ⑤ ⑥ ⑦	■	10
A10051225622	HFM 1225.06 BASE-X	ZX	SKM 1225	12	25	6	65	26°	① ② ③ ④ ⑤ ⑥ ⑦	■	5
A5005122562214	HFM 1225.06 BASE-X	ZX	SKM 1225	12	25	1/4"	65	26°	① ② ③ ④ ⑤ ⑥ ⑦	■	5

Shape N, Inverted cone



Ordering example: A10120307305

Further dimensions, cuts and shank lengths on request

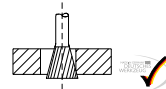
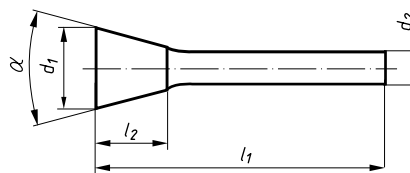

PG 1

Product number	Description	Cut	similar to DIN 8033	d ₁ mm	l ₂ mm	d ₂ mm	l ₁ mm	α	recommended for Information on page 438		
A10120307305	HFN 0307.03	Z5	WKN 0307	3	7	3	40	10°	① ② ③ ④ ⑦	■	1
A10120307308	HFN 0307.03	Z7 Steel	WKN 0307	3	7	3	40	10°	① ② ③ ⑤ ⑦	■	1
A10120607305	HFN 0607.03	Z5	WKN 0607	6	7	3	37	10°	① ② ③ ④ ⑦	■	1
A10120607604	HFN 0607.06	Z4	WKN 0607	6	7	6	50	10°	② ③ ④ ⑦ ⑧	■	1
A10120607605	HFN 0607.06	Z5	WKN 0607	6	7	6	50	10°	① ② ③ ④ ⑦	■	1
A10121013603	HFN 1013.06	Z3	WKN 1013	10	13	6	53	10°	① ② ③ ④ ⑦	■	1
A10121013604	HFN 1013.06	Z4	WKN 1013	10	13	6	53	10°	② ③ ④ ⑦ ⑧	■	1
A10121213603	HFN 1213.06	Z3	WKN 1213	12	13	6	53	20°	① ② ③ ④ ⑦	■	1
A10121213604	HFN 1213.06	Z4	WKN 1213	12	13	6	53	20°	② ③ ④ ⑦ ⑧	■	1
A10121613803	HFN 1613.08	Z3	WKN 1613	16	13	8	53	20°	① ② ③ ④ ⑦	■	1
A10122013604	HFN 2013.06	Z4	---	20	13	6	53	30°	① ② ③ ⑤ ⑦	■	1

Shape N, Inverted cone with end cut

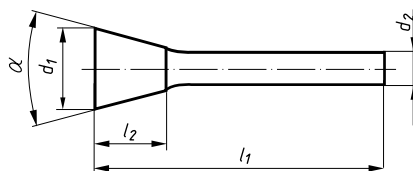

Ordering example: A101203073050001

Further dimensions, cuts and shank lengths on request

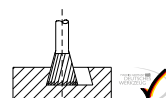

PG 1

Product number	Description	Cut	similar to DIN 8033	d ₁ mm	l ₂ mm	d ₂ mm	l ₁ mm	α	recommended for Information on page 438		
A101203073050001	HFNS 0307.03	Z5	WKN-S 0307	3	7	3	40	10°	1 2 3 4 7	■	1
A101203073080001	HFNS 0307.03	Z7 Steel	WKN-S 0307	3	7	3	40	10°	1 2 3 5 7	■	1
A101206073050001	HFNS 0607.03	Z5	WKN-S 0607	6	7	3	37	10°	1 2 3 4 7	■	1
A101210136030001	HFNS 1013.06	Z3	WKN-S 1013	10	13	6	53	10°	1 2 3 4 7	■	1
A101212136030001	HFNS 1213.06	Z3	WKN-S 1213	12	13	6	53	20°	1 2 3 4 7	■	1
A101216136040001	HFNS 1613.06	Z4	WKN-S 1613	16	13	6	53	20°	2 3 4 7 8	■	1
A101216138030001	HFNS 1613.08	Z3	WKN-S 1613	16	13	8	53	20°	1 2 3 5 7	■	1

Shape R, Trimming burr (external)

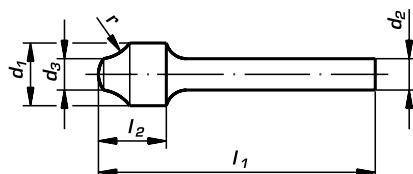

Ordering example: A10140812603

Further dimensions, cuts and shank lengths on request

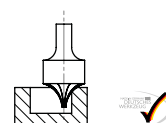

PG 1

Product number	Description	Cut	d ₁ mm	d ₃ mm	l ₂ mm	d ₂ mm	l ₁ mm	recommended for Information on page 438		
A10140812603	HFR 0812.06	Z3	8	3	12	6	52	1 2 3 4 7	■	1
A10141015603	HFR 1015.06	Z3	10	2	15	6	55	1 2 3 4 7	■	1
A10141215603	HFR 1215.06	Z3	12	6	15	6	55	1 2 3 4 7	■	1
A10141215803	HFR 1215.08	Z3	12	6	15	8	55	1 2 3 4 7	■	1
A10141315603	HFR 1315.06	Z3	13	3	15	6	55	1 2 3 4 7	■	1
A10141315605	HFR 1315.06	Z5	13	3	15	6	55	1 2 3 4 7	■	1
A10141315803	HFR 1315.08	Z3	13	3	15	8	55	1 2 3 4 7	■	1

HFT Backward deburring tool

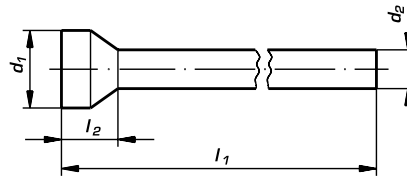

Ordering example: A10170504303

Further dimensions, cuts and shank lengths on request

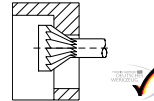
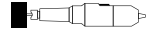

PG 1

Product number	Description	Cut	d ₁ mm	l ₂ mm	d ₂ mm	l ₁ mm	recommended for Information on page 438		
A10170504303	HFT 0504.03	Z3	5	4	3	40	① ② ③ ④ ⑦	■	1
A10170705303	HFT 0705.03	Z3	7	5	3	40	① ② ③ ④ ⑦	■	1
A10171006603	HFT 1006.06	Z3	10	6	6	60	① ② ③ ④ ⑦	■	1
A10171207603	HFT 1207.06	Z3	12	7	6	65	① ② ③ ④ ⑦	■	1
A10171610603	HFT 1610.06	Z3	16	10	6	70	① ② ③ ④ ⑦	■	1
A10171610803	HFT 1610.08	Z3	16	10	8	120	① ② ③ ④ ⑦	■	1
A10171811803	HFT 1811.08	Z3	18	11	8	120	① ② ③ ④ ⑦	■	1

Safety instructions:

Reduced speed for burrs with a total length l₁=120 mm: max. 11.000 rpm.

Applications:

- Reverse deburring of bores at difficult to access areas, for example in pipes, containers and construction components
- Reverse chamfering of bores

Advantages:

- Defined 45° bevel
- For different bore diameters
- Variable chamfer width
- Quick work result

Tool-Sets F10 S3 and F10 S6



Ordering example: A1039000509

10 pieces



PG 1

Product number	Description	Image	Cut	Shank Ø mm	1 piece each	recommended for Information on page 438		
A10390010	F10 S3		Z7 Steel	3	HFA 0313, HFA 0613, HFC 0313, HFC 0613, HFD 0302, HFD 0605, HFG 0313, HFG 0613, HFM 0613, HFF 0313	① ② ③ ⑤ ⑦	■	1
A1039001006	F10 S6		Z7 Steel	6	HFAS 0616, HFAS 1225, HFC 0616, HFC 1225, HFD 0605, HFD 1210, HFG 0618, HFG 1225, HFF 0820, HFF 1225	① ② ③ ⑤ ⑦	■	1

Tool-Sets F5 S3 and F10 S6



Ordering example: A1039000509

5 pieces and 10 pieces



PG 1

Product number	Description	Image	Cut	Shank Ø mm	1 piece each	recommended for Information on page 438		
A1039001020	Assortment		Z42 Inox/Steel	6	HFA 0616, HFA 1225, HFC 0616, HFC 1225, HFD 0605, HFD 1210, HFG 0618, HFG 1225, HFF 0618, HFF 1225	① ② ③ ④	■	1
A1039000509	Assortment		Z9 Alu	3	HFA 0313, HFC 0313, HFD 0403, HFF 0313, HFG 0313	⑥ ⑧	■	1
A10390005096	Assortment		Z9 Alu	6	HFA 0616, HFC 0616, HFM 0618, HFF 0618, HFD 0605	⑥ ⑧	■	1

Tool-set, BASE-X, F5 S6



Ordering example: A10390053

5 pieces

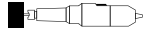

PG 1

Product number	Description	Image	Cut	Shank Ø mm	1 piece each	recommended for							PG 1		
						Information on page 438									
A10390053	F5 S3 Tool-sets BASE-X		ZX	3	HFA 0313, HFC 0313, HFD 0605, HFF 0313, HFG 0313	①	②	③	④	⑤	⑥	⑦		■	1
A10390056	F5 S6 Tool-sets BASE-X		ZX	6	HFA 1225, HFC 1225, HFD 1210, HFF 1225, HFG 1225	①	②	③	④	⑤	⑥	⑦		■	1

Tools for hand-held and floor-stand application



PG 1

Trimming burr

delivery on request

Range of application:

- General machine building
- shipbuilding

Tools for stationary use



PG 1

Differential drill, radius mill, shank-end mill, die mill, profile mill

delivery on request

Range of application:

- Tool construction
- Turbine construction
- Aerospace industry
- General machine building

In addition to rotary burrs, we also produce tungsten carbide milling tools in special shapes and sizes for stationary application.

We supply these milling cutters with a diameter **of 20 mm** maximum diameter and with a maximum length **of 250 mm**; they differ from our extensive standard range by the shape, tool material and geometry (rake, clearance and helix angles).

Burrs of HSS

66	Technical Information
67	A summary of available shapes
69	Types of cut and their application
70	Burrs of HSS

Product line marking

The product lines are illustrated by star symbols at the top of the table; please refer to page **14** and **15**.

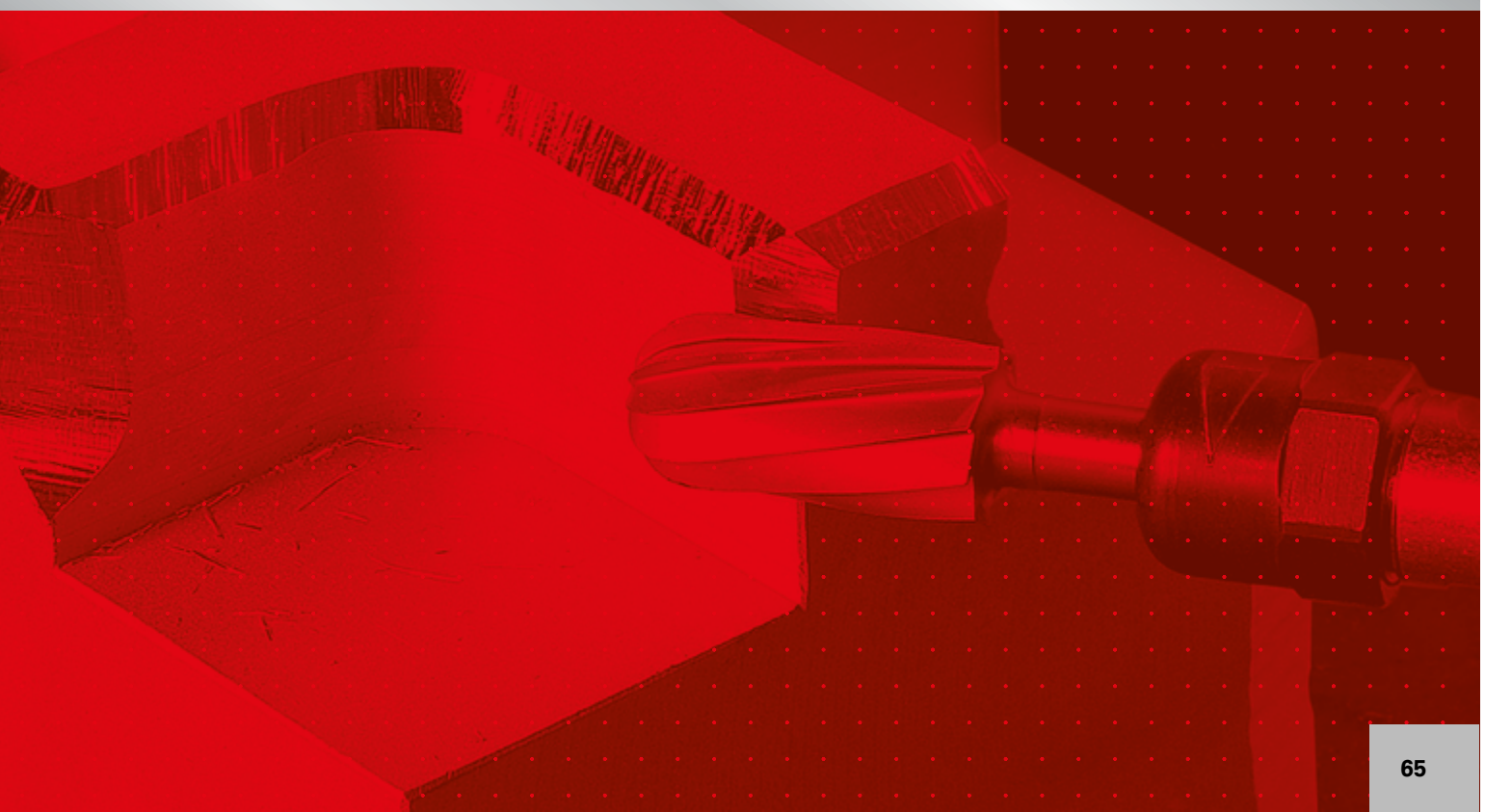

Technical Information



Quality

LUKAS burrs are manufactured from high quality and well-proven steels. Our modern automatic flute grinding machines guarantee a top quality product.

Application

Provided the correct type and speed are used, LUKAS HSS burrs will economically machine a wide variety of materials. Regarding cutting speeds, please refer to the table on page **62** or according to the table illustrating the various cuts on page **63**.

A rule of thumb: Coarse cuts for soft materials – fine cuts for hard materials.

Power tool

LUKAS HSS burrs can be used on any air or electric powered machines. To achieve the optimal performance, the machines must be run at the correct speed, the collets must run true, and the bearings to be in good condition.

Shanks

Standard shank length is 40 mm. To reach inaccessible working areas, extra long shanks are available on request.

Packaging







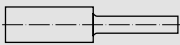
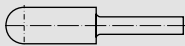
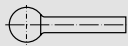
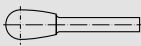
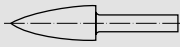

Depending on burr dimension and quantity ordered, we choose the most appropriate packing method from our environmentally-friendly unit packs (5 or 10 pieces).

Special tools

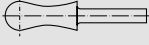
We can manufacture HSS burrs to your design and drawing and guarantee the usual high quality LUKAS standard.

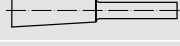
A summary of available shapes

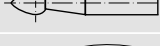

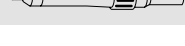
Shape	Type	Shape	Page
	Cylindrical	A	70
	Cylindrical round nose	C	71
	Spherical	D	72
	Oval	E	73
	Arch pointed nose	G	74
	Flame	H	74
	Club	K	75
	Conical round nose	L	75
	Conical pointed nose	M	76
	Inverted cone	N	76
	Edge trimming burr	W	77
	Miniature Burrs, Shank 3 mm	-	78
	Miniature Burrs, Shank 6 mm	-	80
	Burrs with internal thread	-	81
	Tools sets	-	82
	Power Tools	-	369

Three steps to your optimum burr:



- 1 Select the **material** and **machining mode** (coarse to fine) from the table and
- 2 Read off the recommended **cut** and **cutting speed**.
- 3 Determine the appropriate **speed** for your power tool in the second table.

Recommendations for using burrs of HSS

1			2		
Material	LUKAS material group (see also fold-out tab)	Strength [N/mm ²]	Machining	Cut	Recommended cutting speed v_c [m/min]
Steel, cast steel	1 Steel and cast steel	< 800	coarse	Z2	50–100
			medium	Z3	100–200
			fine	Z5	50–200
	2 Alloyed / hardened & tempered steels	800 to 1200	coarse	Z2	50–100
			medium	Z3	100–200
			fine	Z5	50–200
Non-ferrous metal 1	6 Aluminium, magnesium and copper alloys	to 450	coarse	Z1	200–300
			medium	Z2	150–300
Plastics and wood	8 Plastic / wood / rubber	20 to 400	coarse	Z1	200–300
			fine	Z2	150–300

Rotational speeds for milling tools

based on the tool diameter and cutting speed

3							
Recommended cutting speed v_c [m/min]							
		50	100	150	200	250	300
Rotational speed [min ⁻¹]							
Tool diameter [mm]	2	8.000	16.000	24.000	32.000	40.000	48.000
	3	5.000	11.000	16.000	21.000	27.000	32.000
	4	4.000	8.000	12.000	16.000	20.000	24.000
	6	3.000	5.000	8.000	11.000	13.000	16.000
	8	2.000	4.000	6.000	8.000	10.000	12.000
	10	2.000	3.000	5.000	6.000	8.000	10.000
	12	1.000	3.000	4.000	5.000	7.000	8.000
	16	1.000	2.000	3.000	4.000	5.000	6.000
	20	1.000	2.000	2.000	3.000	4.000	5.000
	22	1.000	1.000	2.000	3.000	4.000	4.000
	25	1.000	1.000	2.000	3.000	3.000	4.000
	30	1.000	1.000	2.000	2.000	3.000	3.000
	35	–	1.000	1.000	2.000	2.000	3.000

Please see page 369 to 381 for appropriate power tools.

Tip: Page 67 contains a complete overview of the shapes for your chosen milling tool.

Machining





coarse

medium

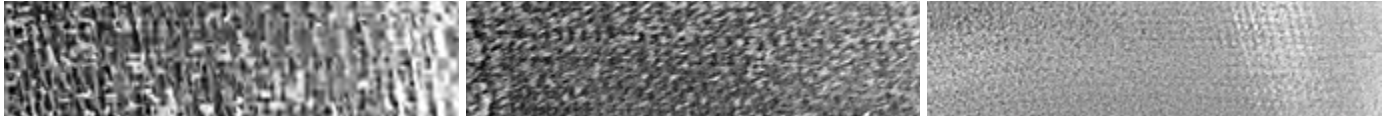
fine

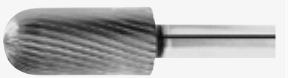

Cuts

	Z 1	Coarse cut for soft materials		Z 3	Medium single cut
	Z 2	Robust single cut for high stock removal		Z 5	Very fine single cut for high-quality surfaces

Shape A, Cylindrical

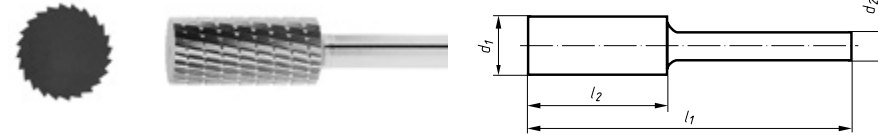

Ordering example: A12000304605

Further dimensions, cuts and shank lengths on request

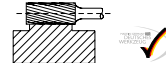
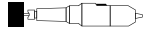

PG 1

Product number	Description	Cut	d ₁ mm	l ₂ mm	l ₁ mm	d ₂ mm	recommended for Information on page 438								
A12000304605	MFA 0304.06	Z5	3	4,5	60	6	① ②				⑥			■	10
A12000607605	MFA 0607.06	Z5	6	7	60	6	① ②				⑥			■	10
A12000616601	MFA 0616.06	Z1	6	16	56	6					⑥	⑧		■	10
A12000616602	MFA 0616.06	Z2	6	16	56	6					⑥	⑧		■	10
A12000616603	MFA 0616.06	Z3	6	16	56	6	① ②							■	10
A12000820603	MFA 0820.06	Z3	8	20	60	6	① ②							■	10
A12001013602	MFA 1013.06	Z2	10	13	53	6					⑥	⑧		■	10
A12001013603	MFA 1013.06	Z3	10	13	53	6	① ②							■	10
A12001020603	MFA 1020.06	Z3	10	20	60	6	① ②							■	10
A12001225601	MFA 1225.06	Z1	12	25	65	6					⑥	⑧		■	5
A12001225602	MFA 1225.06	Z2	12	25	65	6					⑥	⑧		■	5
A12001225603	MFA 1225.06	Z3	12	25	65	6	① ②							■	5
A12001225605	MFA 1225.06	Z5	12	25	65	6	① ②				⑥			■	5
A12001625601	MFA 1625.06	Z1	16	25	65	6					⑥	⑧		■	5
A12001625602	MFA 1625.06	Z2	16	25	65	6					⑥	⑧		■	5
A12001625603	MFA 1625.06	Z3	16	25	65	6	① ②							■	5

Shape A, Cylinder with end-cut

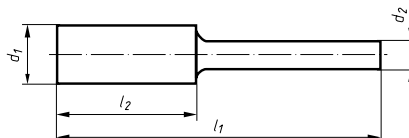

Ordering example: A120006166010001

Further dimensions, cuts and shank lengths on request



PG 1

Product number	Description	Cut	d ₁ mm	l ₂ mm	l ₁ mm	d ₂ mm	recommended for Information on page 438					
A120006166010001	MFAS 0616.06	Z1	6	16	56	6			⑥	⑧	■	10
A120006166020001	MFAS 0616.06	Z2	6	16	56	6			⑥	⑧	■	10
A120006166030001	MFAS 0616.06	Z3	6	16	56	6	①	②			■	10
A120006166050001	MFAS 0616.06	Z5	6	16	56	6	①	②	⑥		■	10
A120008206030001	MFAS 0820.06	Z3	8	20	60	6	①	②			■	10
A120010136020001	MFAS 1013.06	Z2	10	13	53	6			⑥	⑧	■	10
A120010136030001	MFAS 1013.06	Z3	10	13	53	6	①	②			■	10
A120012256010001	MFAS 1225.06	Z1	12	25	65	6			⑥	⑧	■	5
A120012256020001	MFAS 1225.06	Z2	12	25	65	6			⑥	⑧	■	5
A120012256030001	MFAS 1225.06	Z3	12	25	65	6	①	②			■	5
A120016256010001	MFAS 1625.06	Z1	16	25	65	6			⑥	⑧	■	5
A120016256020001	MFAS 1625.06	Z2	16	25	65	6			⑥	⑧	■	5
A120016256030001	MFAS 1625.06	Z3	16	25	65	6	①	②			■	5

Shape C, Cylindrical round nose

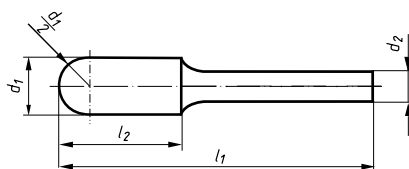

Ordering example: A12010304605

Further dimensions, cuts and shank lengths on request

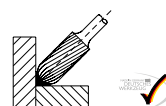

PG 1

Product number	Description	Cut	d ₁ mm	l ₂ mm	l ₁ mm	d ₂ mm	recommended for Information on page 438					
A12010304605	MFC 0304.06	Z5	3	4,5	60	6	①	②	⑥		■	10
A12010620601	MFC 0620.06	Z1	6	20	60	6			⑥	⑧	■	10
A12010620602	MFC 0620.06	Z2	6	20	60	6			⑥	⑧	■	10
A12010620603	MFC 0620.06	Z3	6	20	60	6	①	②			■	10
A12010620605	MFC 0620.06	Z5	6	20	60	6	①	②	⑥		■	10
A12010820603	MFC 0820.06	Z3	8	20	60	6	①	②			■	10
A12010850601	MFC 0850.06	Z1	8	50	90	6			⑥	⑧	■	10

Inox/Steel

Steel

Aluminium

Stone

Cast material

Plastic

Titanium

Shape C, Round nose

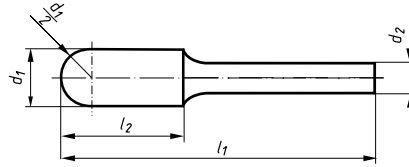

Ordering example: A12010304605

Further dimensions, cuts and shank lengths on request

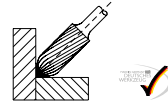
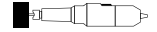

PG 1

Product number	Description	Cut	d ₁ mm	l ₂ mm	l ₁ mm	d ₂ mm	recommended for	Information on page 438				
A12010850602	MFC 0850.06	Z2	8	50	90	6			⑥	⑧	■	10
A12011020603	MFC 1020.06	Z3	10	20	60	6	①	②			■	10
A12011225601	MFC 1225.06	Z1	12	25	65	6			⑥	⑧	■	5
A12011225602	MFC 1225.06	Z2	12	25	65	6			⑥	⑧	■	5
A12011225603	MFC 1225.06	Z3	12	25	65	6	①	②			■	5
A12011225605	MFC 1225.06	Z5	12	25	65	6	①	②	⑥		■	5

Shape D, Spherical

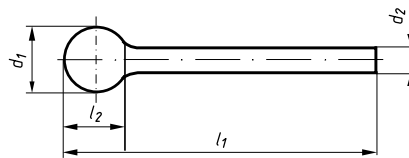

Ordering example: A12050303603

Further dimensions, cuts and shank lengths on request

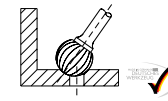

PG 1

Product number	Description	Cut	d ₁ mm	l ₂ mm	d ₂ mm	l ₁ mm	recommended for	Information on page 438				
A12050303603	MFD 0302.06	Z3	3	2	6	60	①	②			■	10
A120503036030001	MFD 0303.06	Z3	3,5	3	6	60	①	②			■	10
A12050404603	MFD 0403.06	Z3	4	3	6	60	①	②			■	10
A120504046020001	MFD 0404.06	Z2	4,5	4	6	60			⑥	⑧	■	10
A120504046030001	MFD 0404.06	Z3	4,5	4	6	60	①	②			■	10
A12050505603	MFD 0504.06	Z3	5	4	6	60	①	②			■	10
A12050606602	MFD 0605.06	Z2	6	5	6	60			⑥	⑧	■	10
A12050606603	MFD 0605.06	Z3	6	5	6	60	①	②			■	10
A12050808601	MFD 0807.06	Z1	8	7	6	60			⑥	⑧	■	10
A12050808602	MFD 0807.06	Z2	8	7	6	60			⑥	⑧	■	10
A12050808603	MFD 0807.06	Z3	8	7	6	60	①	②			■	10
A12050808605	MFD 0807.06	Z5	8	7	6	60	①	②	⑥		■	10
A12051010602	MFD 1009.06	Z2	10	9	6	60			⑥	⑧	■	10
A12051010603	MFD 1009.06	Z3	10	9	6	60	①	②			■	10

Shape D, Spherical

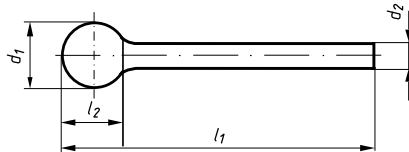

Ordering example: A12050303603

Further dimensions, cuts and shank lengths on request

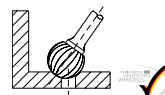

PG 1

Product number	Description	Cut	d ₁ mm	l ₂ mm	d ₂ mm	l ₁ mm	recommended for Information on page 438				
A12051010605	MFD 1009.06	Z5	10	9	6	60	① ②		⑥	■	10
A12051212601	MFD 1210.06	Z1	12	10	6	60			⑥ ⑧	■	5
A12051212603	MFD 1210.06	Z3	12	10	6	60	① ②			■	5
A12051614601	MFD 1614.06	Z1	16	14	6	60			⑥ ⑧	■	5
A12051614602	MFD 1614.06	Z2	16	14	6	60			⑥ ⑧	■	5
A12051614603	MFD 1614.06	Z3	16	14	6	60	① ②		⑥	■	5

Shape E, Oval

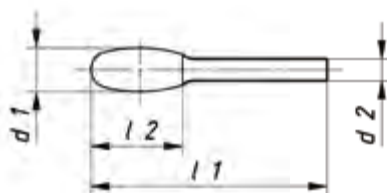

Ordering example: A12080607605

Further dimensions, cuts and shank lengths on request

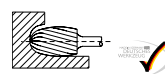

PG 1

Product number	Description	Cut	d ₁ mm	l ₂ mm	d ₂ mm	l ₁ mm	recommended for Information on page 438				
A12080607605	MFE 0607.06	Z5	6	7	6	60	① ②		⑥	■	10
A12081220601	MFE 1220.06	Z1	12	20	6	60			⑥ ⑧	■	5
A12081220603	MFE 1220.06	Z3	12	20	6	60	① ②			■	5
A12081625601	MFE 1625.06	Z1	16	25	6	60			⑥ ⑧	■	5
A12081625602	MFE 1625.06	Z2	16	25	6	60			⑥ ⑧	■	5
A12081625603	MFE 1625.06	Z3	16	25	6	60	① ②		⑥	■	5

Shape G, Arch pointed nose

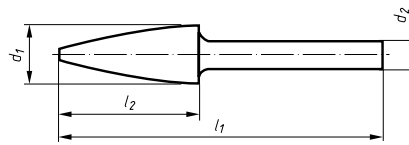

Ordering example: A12060618601

Further dimensions, cuts and shank lengths on request

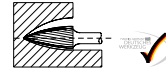
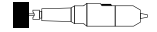

PG 1

Product number	Description	Cut	d ₁ mm	l ₂ mm	d ₂ mm	l ₁ mm	recommended for Information on page 438			
A12060618601	MFG 0618.06	Z1	6	18	6	58		⑥	⑧	■ 10
A12060618602	MFG 0618.06	Z2	6	18	6	58		⑥	⑧	■ 10
A12060618603	MFG 0618.06	Z3	6	18	6	58	① ②			■ 10
A12061220601	MFG 1220.06	Z1	12	20	6	60		⑥	⑧	■ 5
A12061220602	MFG 1220.06	Z2	12	20	6	60		⑥	⑧	■ 5
A12061220603	MFG 1220.06	Z3	12	20	6	60	① ②			■ 5
A12061225603	MFG 1225.06	Z3	12	25	6	65	① ②			■ 5
A12061230601	MFG 1230.06	Z1	12	30	6	70		⑥	⑧	■ 5
A12061230602	MFG 1230.06	Z2	12	30	6	70		⑥	⑧	■ 5
A12061230603	MFG 1230.06	Z3	12	30	6	70	① ②			■ 5
A12061230605	MFG 1230.06	Z5	12	30	6	70	① ②	⑥		■ 5
A12061630601	MFG 1630.06	Z1	16	30	6	70		⑥	⑧	■ 5
A12061630602	MFG 1630.06	Z2	16	30	6	70		⑥	⑧	■ 5
A12061630603	MFG 1630.06	Z3	16	30	6	70	① ②			■ 5
A12061630605	MFG 1630.06	Z5	16	30	6	70	① ②	⑥		■ 5

Shape H, Flame

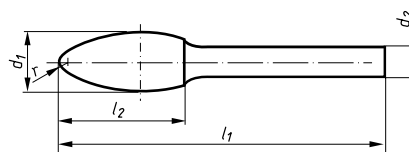

Ordering example: A12070305605

Further dimensions, cuts and shank lengths on request

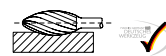
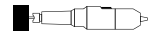

PG 1

Product number	Description	Cut	d ₁ mm	l ₂ mm	d ₂ mm	l ₁ mm	recommended for Information on page 438			
A12070305605	MFH 0305.06	Z5	3	5	6	60	① ②	⑥		■ 10
A12070820603	MFH 0820.06	Z3	8	20	6	60	① ②			■ 10
A12071230603	MFH 1230.06	Z3	12	30	6	70	① ②			■ 5
A12071635603	MFH 1635.06	Z3	16	35	6	75	① ②			■ 5

Shape K, Club

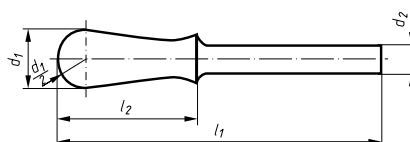

Ordering example: A12090620602

Further dimensions, cuts and shank lengths on request

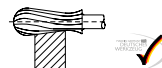

PG 1

Product number	Description	Cut	d ₁ mm	l ₂ mm	d ₂ mm	l ₁ mm	recommended for Information on page 438		
A12090620602	MFK 0620.06	Z2	6	20	6	60	⑥ ⑧	■	10
A12090620603	MFK 0620.06	Z3	6	20	6	60	① ②	■	10
A12091230602	MFK 1230.06	Z2	12	30	6	70	⑥ ⑧	■	5
A12091230603	MFK 1230.06	Z3	12	30	6	70	① ②	■	5

Shape L, Conical round nose

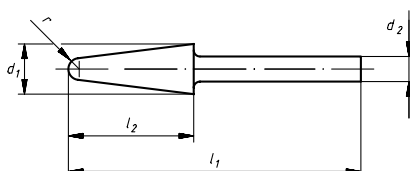

Ordering example: A12031020602

Further dimensions, cuts and shank lengths on request

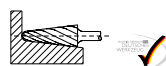

PG 1

Product number	Description	Cut	d ₁ mm	l ₂ mm	d ₂ mm	l ₁ mm	recommended for Information on page 438		
A12031020602	MFL 1020.06	Z2	10	20	6	60	⑥ ⑧	■	10
A12031020603	MFL 1020.06	Z3	10	20	6	60	① ②	■	10
A12031230603	MFL 1230.06	Z3	12	30	6	70	① ②	■	5
A12031630601	MFL 1630.06	Z1	16	30	6	70	⑥ ⑧	■	5
A12031630602	MFL 1630.06	Z2	16	30	6	70	⑥ ⑧	■	5
A12031630603	MFL 1630.06	Z3	16	30	6	70	① ②	■	5
A12031630605	MFL 1630.06	Z5	16	30	6	70	① ② ⑥	■	5

Shape M, Conical pointed nose

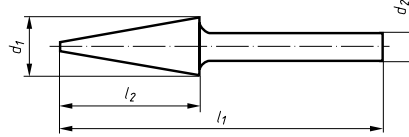

Ordering example: A12020304605

Further dimensions, cuts and shank lengths on request

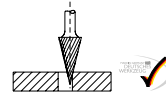
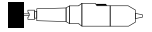

PG 1

Product number	Description	Cut	d ₁ mm	l ₂ mm	d ₂ mm	l ₁ mm	recommended for Information on page 438			
A12020304605	MFM 0304.06	Z5	3	4,5	6	60	① ②	⑥		■ 10
A12020607605	MFM 0607.06	Z5	6	7	6	60	① ②	⑥		■ 10
A12020618601	MFM 0618.06	Z1	6	18	6	58		⑥ ⑧		■ 10
A12020618602	MFM 0618.06	Z2	6	18	6	58		⑥ ⑧		■ 10
A12020618603	MFM 0618.06	Z3	6	18	6	58	① ②			■ 10
A12020820603	MFM 0820.06	Z3	8	20	6	60	① ②			■ 10
A12021020602	MFM 1020.06	Z2	10	20	6	60		⑥ ⑧		■ 10
A12021020603	MFM 1020.06	Z3	10	20	6	60	① ②			■ 10
A12021225601	MFM 1225.06	Z1	12	25	6	65		⑥ ⑧		■ 5
A12021225603	MFM 1225.06	Z3	12	25	6	65	① ②			■ 5
A12021230601	MFM 1230.06	Z1	12	30	6	70		⑥ ⑧		■ 5
A12021230602	MFM 1230.06	Z2	12	30	6	70		⑥ ⑧		■ 5
A12021230603	MFM 1230.06	Z3	12	30	6	70	① ②			■ 5
A12021230605	MFM 1230.06	Z5	12	30	6	70	① ②	⑥		■ 5

Shape N, Inverted cone

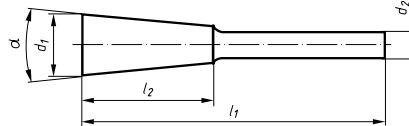

Ordering example: A12040303605

Further dimensions, cuts and shank lengths on request

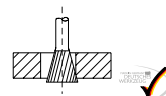

PG 1

Product number	Description	Cut	d ₁ mm	l ₂ mm	d ₂ mm	l ₁ mm	recommended for Information on page 438			
A12040303605	MFN 0303.06	Z5	3	3	6	60	① ②	⑥		■ 10
A12040606605	MFN 0606.06	Z5	6	6	6	60	① ②	⑥		■ 10
A12041213601	MFN 1213.06	Z1	12	13	6	53		⑥ ⑧		■ 5
A12041213603	MFN 1213.06	Z3	12	13	6	53	① ②			■ 5
A12041230603	MFN 1230.06	Z3	12	30	6	70	① ②	⑥		■ 5

Shape N, Inverted cone with end-cut



Ordering example: A120412136010001

Further dimensions, cuts and shank lengths on request

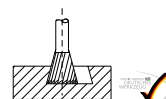
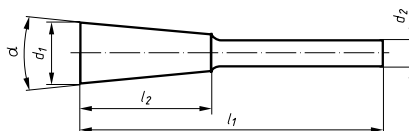

PG 1

Product number	Description	Cut	d ₁ mm	l ₂ mm	d ₂ mm	l ₁ mm	recommended for				Information on page 438	PG 1			
A120412136010001	MFNS 1213.06	Z1	12	13	6	53					⑥	⑧		■	5
A120412136030001	MFNS 1213.06	Z3	12	13	6	53	①	②						■	5
A120412306030001	MFNS 1230.06	Z3	12	30	6	70	①	②						■	5

Shape W, Cylindrical multiple concave burrs



Ordering example: A12430340

Further dimensions, cuts and shank lengths on request

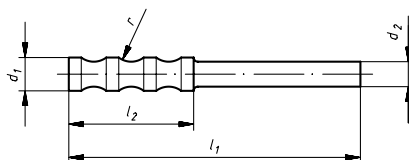

PG 1

Product number	Description	Cut	d ₁ mm	l ₂ mm	d ₂ mm	l ₁ mm	recommended for				Information on page 438	PG 1			
A12430340	MFW 0620.06	16	6	20	6	60	①	②			⑥			■	10
A12433401	MFW 0830.06	18	8	30	6	70	①	②			⑥			■	10

Miniature Burrs, shank 3 mm

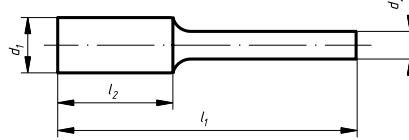

Ordering example: A1235080605

Further dimensions, cuts and shank lengths on request

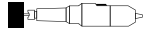

PG 1

Product number	Description	Shape	Cut	d ₁ mm	l ₂ mm	l ₁ mm	recommended for Information on page 438			
A1236082705	MF 827		Z5	4	2,8	40	① ②		⑥	■ 10
A1236082905	MF 829		Z5	6	4,2	41	① ②		⑥	■ 10
A1236083105	MF 831		Z5	8	5,5	43	① ②		⑥	■ 10
A1236083705	MF 837		Z5	6	6	43	① ②		⑥	■ 10
A1236083905	MF 839		Z5	8	8	45	① ②		⑥	■ 10
A1237084005	MF 840		Z5	1,6	2,8	40	① ②		⑥	■ 10
A1237084105	MF 841		Z5	2,3	4	41	① ②		⑥	■ 10
A1237084205	MF 842		Z5	3,2	5,6	43	① ②		⑥	■ 10
A1237084305	MF 843		Z5	4	7	44	① ②		⑥	■ 10
A1237084405	MF 844		Z5	5	8,7	46	① ②		⑥	■ 10
A1237084505	MF 845		Z5	6	10,5	46	① ②		⑥	■ 10
A1237084605	MF 846		Z5	7	12,5	46	① ②		⑥	■ 10
A1237084705	MF 847		Z5	8	14	46	① ②		⑥	■ 10
A1238084805	MF 848		Z5	1,6	1,5	38	① ②		⑥	■ 10
A1238084905	MF 849		Z5	2,3	2,1	39	① ②		⑥	■ 10
A1238085005	MF 850		Z5	3,2	3	40	① ②		⑥	■ 10
A1238085105	MF 851		Z5	4	3,8	41	① ②		⑥	■ 10
A1238085205	MF 852		Z5	5	4,8	42	① ②		⑥	■ 10
A1238085305	MF 853		Z5	6	5,6	43	① ②		⑥	■ 10

Miniature Burrs, shank 3 mm

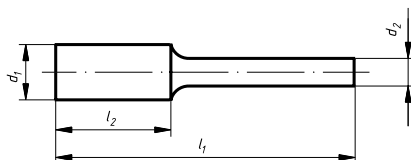

Ordering example: A1235080605

Further dimensions, cuts and shank lengths on request



PG 1

Product number	Description	Shape	Cut	d ₁ mm	l ₂ mm	l ₁ mm	recommended for Information on page 438			
A1238085405	MF 854		Z5	7	6,7	44	① ②		⑥	■ 10
A1238085505	MF 855		Z5	8	7,7	45	① ②		⑥	■ 10
A1235080605	MF 806		Z5	7	7,5	40	① ②		⑥	■ 10
A1235080705	MF 807		Z5	7	10	42	① ②		⑥	■ 10
A1235080805	MF 808		Z5	8	11	43	① ②		⑥	■ 10
A1235081305	MF 813		Z5	7	10	42	① ②		⑥	■ 10
A1235081405	MF 814		Z5	6	10	42	① ②		⑥	■ 10
A1235081505	MF 815		Z5	7	12	44	① ②		⑥	■ 10
A1239086405	MF 864		Z5	8	2	39	① ②		⑥	■ 10
A1239086505	MF 865		Z5	10	2,5	40	① ②		⑥	■ 10
A1239086605	MF 866		Z5	12	3	40	① ②		⑥	■ 5
A1239086705	MF 867		Z5	14	3,5	41	① ②		⑥	■ 5
A1240086805	MF 868		Z5	8	2	39	① ②		⑥	■ 10
A1240086905	MF 869		Z5	10	2,3	39	① ②		⑥	■ 10
A1240087005	MF 870		Z5	12	2,6	40	① ②		⑥	■ 5
A1240087105	MF 871		Z5	14	3	40	① ②		⑥	■ 5
A1241087205	MF 872		Z5	6	1	38	① ②		⑥	■ 10
A1241087305	MF 873		Z5	8	1	38	① ②		⑥	■ 10
A1241087405	MF 874		Z5	10	1	38	① ②		⑥	■ 10

Miniature Burrs, shank 6 mm

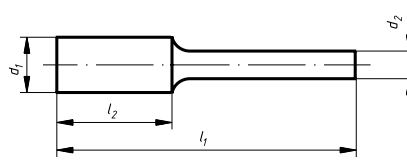

Ordering example: A12000304605

Further dimensions, cuts and shank lengths on request

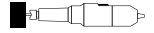

PG 1

Product number	Description	Shape	Cut	d ₁ mm	l ₂ mm	l ₁ mm	recommended for Information on page 438					
A12000304605	MFA 0304.06		Z5	3	4,5	60	① ②			⑥	■	10
A12000607605	MFA 0607.06		Z5	6	7	60	① ②			⑥	■	10
A12010304605	MFC 0304.06		Z5	3	4,5	60	① ②			⑥	■	10
A12050303603	MFD 0302.06		Z3	3	2	60	① ②				■	10
A120503036030001	MFD 0303.06		Z3	3,5	3	60	① ②				■	10
A12080607605	MFE 0607.06		Z5	6	7	60	① ②			⑥	■	10
A12070305605	MFH 0305.06		Z5	3	5	60	① ②			⑥	■	10
A12020304605	MFM 0304.06		Z5	3	4,5	60	① ②			⑥	■	10
A12020607605	MFM 0607.06		Z5	6	7	60	① ②			⑥	■	10
A12040303605	MFN 0303.06		Z5	3	3	60	① ②			⑥	■	10
A12040606605	MFN 0606.06		Z5	6	6	60	① ②			⑥	■	10

Burrs with internal thread

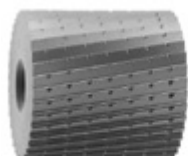

Ordering example: A122022150803

Other dimensions and cuts available on request.



MFAS = with end cut

Suitable mounting arbors pages 419



PG 1

Product number	Description	Shape	Cut	d ₁ mm	l ₂ mm	B mm	recommended for Information on page 438								PG 1	
A122022150803	MFA 2215.08		Z3	22	15	M 8	1	2	3	4		7			■	2
A122030301002	MFA 3030.10		Z2	30	30	M 10	1	2	3	4		7			■	2
A1220221508030001	MFAS 2215.08		Z3	22	15	M 8	1	2	3	4		7			■	2
A1220303010020001	MFAS 3030.10		Z2	30	30	M 10	1	2	3	4		7			■	2
A122520180803	MFD 2018.08		Z3	20	18	M 8	1	2	3	4		7			■	2
A122525221001	MFD 2522.10		Z1	25	21	M 10						6		8	■	2
A122525221002	MFD 2522.10		Z2	25	21	M 10	1					5	6		8	■
A122530271203	MFD 3026.12		Z3	30	26	M 12	1	2	3	4		7			■	2
A122825351203	MFE 2535.12		Z3	25	35	M 12	1	2	3	4		7			■	2
A122635551201	MFG 3555.12		Z1	35	55	M 12						6		8	■	2
A122720551001	MFH 2055.10		Z1	20	55/65	M 10						6		8	■	1
A122720551002	MFH 2055.10		Z2	20	55/65	M 10						6		8	■	2
A122320551001	MFL 2055.10		Z1	20	55	M 10						6		8	■	2
A122225401003	MFM 2540.10		Z3	25	40	M10	1	2	3	4		7			■	2

Tool sets, cut 5, shank 3 mm



Ordering example: A1239000110

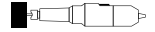

							PG 1		
Product number	Description	Image	Cut	Shank Ø mm	1 piece each	recommended for Information on page 438			
A1239000110	F1		Z5	3	MF 807, MF 813, MF 841, MF 845, MF 850, MF 853, MF 864, MF 866, MF 872, MF 874	① ②	⑥	■	1
A12390003	F3		Z3	6	MFA 0616, MFA 1225, MFC 1225, MFD 0403, MFD 1210, MFE 1220, MFG 1230, MFH 1230, MFK 0620, MFM 0618	① ②	⑥	■	1
A12390004	F4		Z3/Z5	6	Z3 MFA 0616, MFA 1013, MFA 1225, MFC 1225, MFD 0807, MFD 1210, MFE 1220, MFE 1625, MFG 1220, MFG 1230, MFK 1230, MFL 1630, MFM 0618, MFM 1230, MFN 1213, MFN 1230 Z5 MFA 0304, MFA 0607, MFN 0303, MFN 0606	① ②	⑥	■	1

Filing Discs and Rings

Tailor-made solutions

84 Technical Information

84 Filing discs in HSS

85 Filing rings in tool steel

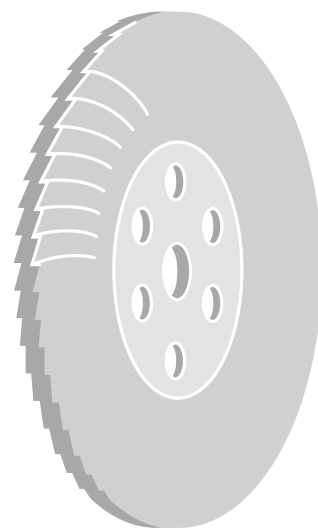

Product line marking

The product lines are illustrated by star symbols at the top of the table; please refer to page **14** and **15**.

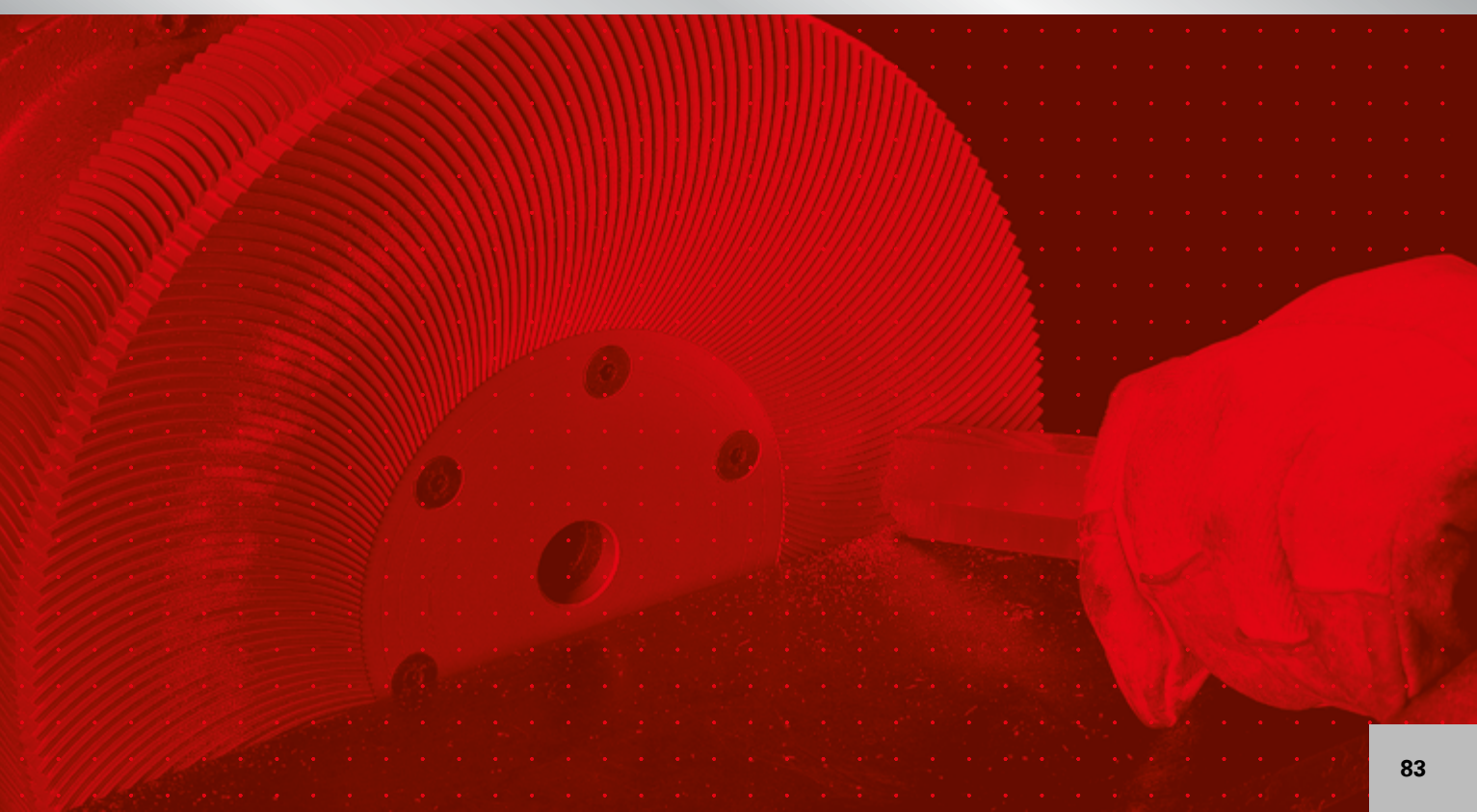

Filing discs in HSS



Filing discs in HSS are ideal for machining soft materials such as plastic or non-ferrous metal. Steel and cast iron can also be economically machined up to a strength of 450 N/mm². Filing discs are mounted on machines and used in stationary applications, in particular for deburring or bevelling workpieces.

In the standard right cutting version, tooth type 1, the tools have teeth on the front and back of the disc (order example: F16-R-1-Z2). Alternatively, customers can choose a left-cutting version (order example: F16-L-1-Z2).

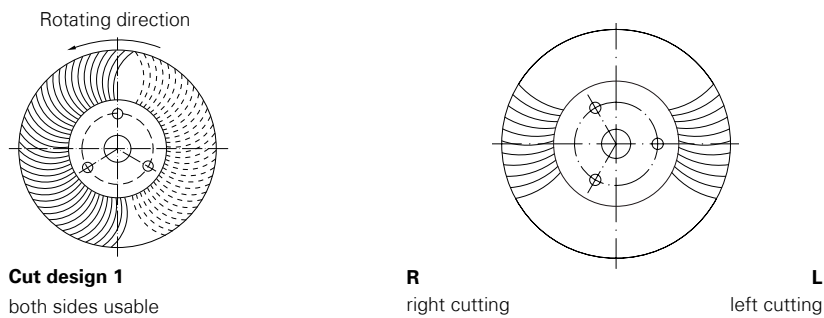

Types of cut and their application

Z1	Z2	Z3
Aluminium alloys plastics $v = 38-150$ m/min Wood $v = 150-300$ m/min	Aluminium alloys plastics $v = 38-150$ m/min Bronze, brass $v = 150-300$ m/min	Steel up to 450 N/mm ² $v = 38-75$ m/min Cast and malleable iron $v = 38-150$ m/min

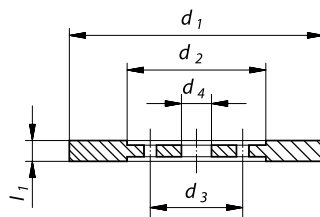
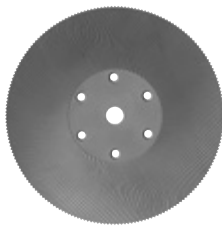

Ordering example: FR16-R-Z1

 = 1 piece

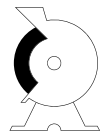

Description	Dimensions						Cut		
	d1 mm	d2 mm	d3 mm	d4 mm	l1 mm	Number of bores	Z1 coarse	Z2 medium	Z3 fine
F 16	160	80	60	15	7	3	F16-R-1-Z1	F16-R-1-Z2	F16-R-1-Z3
F 21	210	80	60	15	8	3	F21-R-1-Z1	F21-R-1-Z2	F21-R-1-Z3
F 26	260	110	90	20	9	6	F26-R-1-Z1	F26-R-1-Z2	F26-R-1-Z3
F31	310	125	90	20	10	6	F31-R-1-Z1	F31-R-1-Z2	F31-R-1-Z3

Filing rings in tool steel



Filing rings in tool steel, like filing discs, are the perfect tool for machining soft materials such as plastic, non-ferrous metal, steel and cast iron (up to a strength of 450 N/mm²). Filing rings, too, are mounted on machines and used in stationary applications, in particular for deburring or bevelling workpieces.

Filing Rings

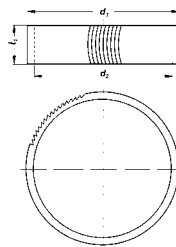

Ordering example: FR 16 Z1

= 1 piece

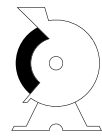

Description	Dimensions			Cut		
	d1 mm	d2 mm	l1 mm	Z1 coarse	Z2 medium	Z3 fine
FR 16	160	145	40	FR 16 Z1	FR 16 Z2	FR 16 Z3
FR 21	210	195	40	FR 21 Z1	FR 21 Z2	FR 21 Z3
FR 26	260	245	40	FR 26 Z1	FR 26 Z2	FR 26 Z3
FR 31	310	295	40	FR 31 Z1	FR 31 Z2	FR 31 Z3

Benefit:

Filing rings are seamless forged. This makes them especially durable.

Engraving cutters of solid carbide

88 General Information

88 Technical Information

89 Engraving cutters of solid carbide



Product line marking

The product lines are illustrated by star symbols at the top of the table; please refer to page **14** and **15**.

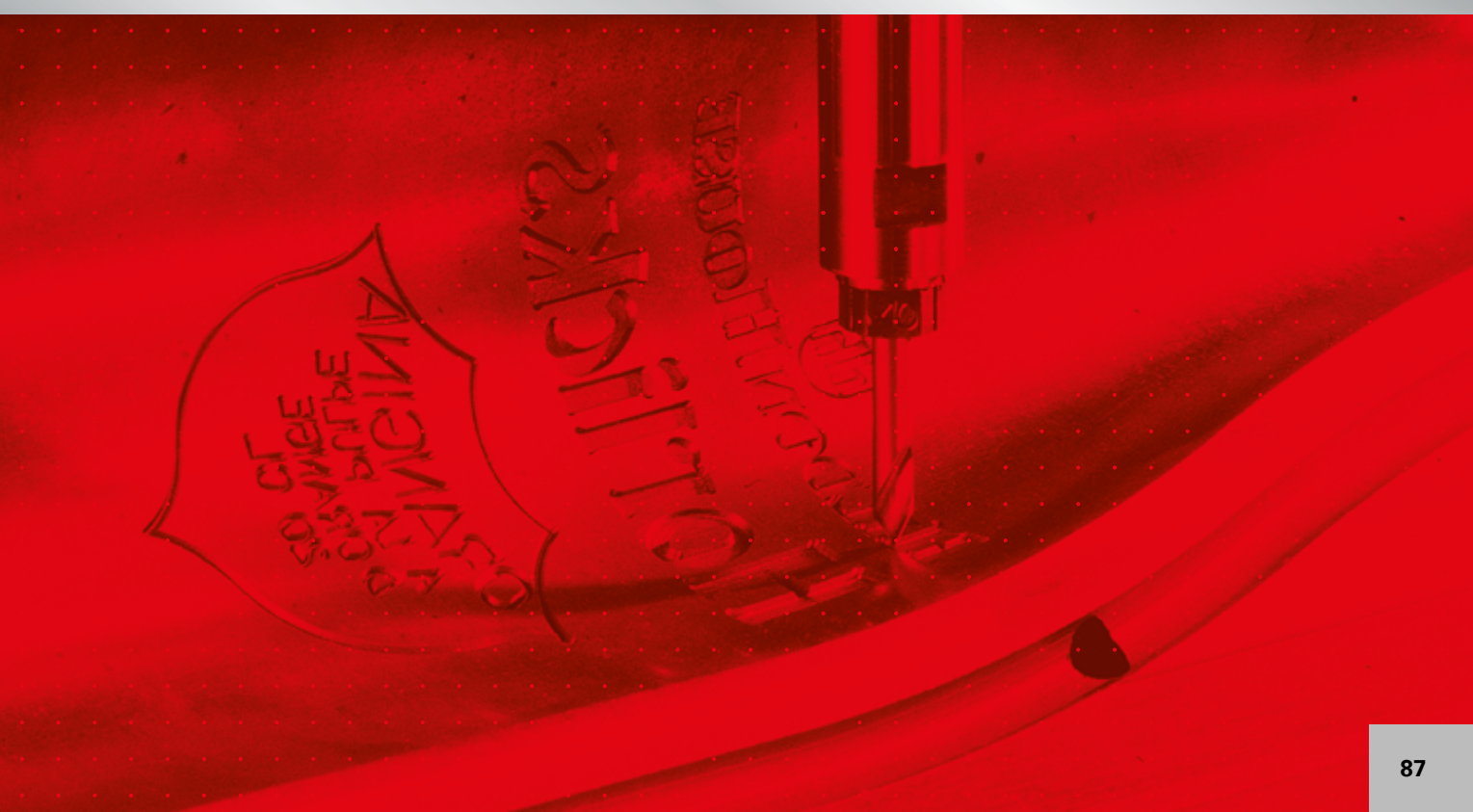



Engraving Cutters of solid carbide K 10 F



K 10 F

Micro grain carbide for machining all materials, for machining steel, cast steel, non-ferrous metals and plastics. Extra long life!

Example	Description	Page
	Engraving cutters of solid carbide	89
	Tungsten carbide cutters, spiral flute type	89

Engraving Cutters – Recommendation for various applications

For optimal results the cutting and lead angles have to suit the material to be machined. The values in the tables are recommendations.

Material to be machined	Recommended cutting and lead angles			Recommended cutting speeds in m/min	Recommended feed rates f_z in mm
	α	β	γ		
Cast iron, cast steel	25°	15°	5°	60–100	0,04–0,1
Steel up to 900 N/mm ²	25°	15°	5°	120–160	0,05–0,08
Steel above 900 N/mm ²	25°	15°	5°	50–70	0,04–0,08
Brass, aluminium	30°	15°	5°	200–400	0,08–0,15
Plastics, reinforced and non-reinforced	35°	15°	5°	200–600	0,05–0,20

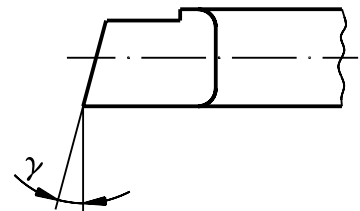
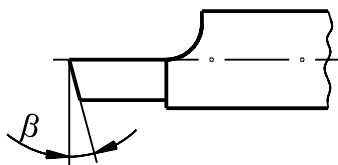
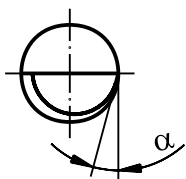

Engraving cutters of solid carbide

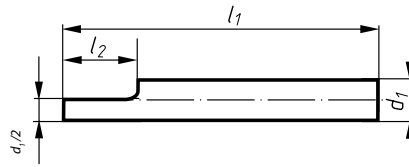
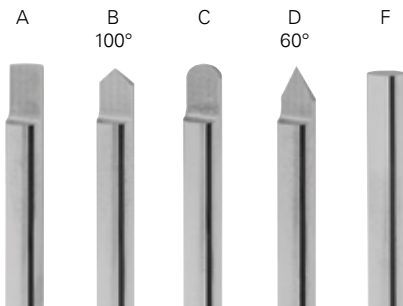

Ordering example: A1300403042

Further profiles and dimensions on request.

$d_1/2$ as per your request

l_2 does not apply to profile F

Tolerance of semi-finished cutting edge + 0,1, finish ground on request



PG 1

Product number	Description	Profile	d_1 mm	l_1 mm	l_2 mm	recommended for Information on page 438		
A1300403042	HGA 03.040	D	3	40	6	1 5 6 8	■	1
A1300404012	HGA 04.040	A	4	40	6	1 5 6 8	■	1
A1300404042	HGA 04.040	D	4	40	6	1 5 6 8	■	1
A1300404062	HGA 04.040	F	4	40	6	1 5 6 8	■	1
A1300405012	HGA 04.060	A	4	60	6	1 5 6 8	■	1
A1300405042	HGA 04.060	D	4	60	6	1 5 6 8	■	1
A1300407012	HGA 06.070	A	6	70	8	1 5 6 8	■	1
A1300407042	HGA 06.070	D	6	70	8	1 5 6 8	■	1
A1300407142	HGA 06.100	D	6	100	8	1 5 6 8	■	1
A1300408012	HGA 08.080	A	8	80	12	1 5 6 8	■	1
A1300408112	HGA 08.100	A	8	100	12	1 5 6 8	■	1
A1300409012	HGA 10.080	A	10	80	14	1 5 6 8	■	1
A1300409112	HGA 10.100	A	10	100	14	1 5 6 8	■	1
A1300410012	HGA 12.080	A	12	80	16	1 5 6 8	■	1
A1300410112	HGA 12.100	A	12	100	16	1 5 6 8	■	1

All dimensions listed on this page:

- exact halving = +0,02, surcharge of 10%.
- Relief grinding = surcharge of 25%.

Engraving cutters of solid carbide, spiral fluted

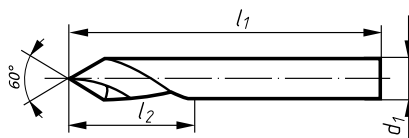

Ordering example: A1300484071

Further dimensions on request.
Relief-grinding 25°

Quality K 10 F = micro grain tungsten carbide



PG 1

Product number	Description	d_1 mm	l_1 mm	l_2 mm	recommended for Information on page 438		
A1300484071	HGS 03.040	3	40	15	6 8	■	1
A1300485071	HGS 04.040	4	40	20	6 8	■	1
A1300486071	HGS 06.050	6	50	22	6 8	■	1

Application: Engraving of non-ferrous metals and plastics with minimum generation of burr.

Mounted Points

92	Technical Information
94	Qualities and areas of application
96	Safety instructions
97	A summary of available shapes
104	Mounted points
125	Assortments
128	Mounted points, tailor-made solutions

Product line marking

The product lines are illustrated by star symbols at the top of the table; please refer to page **14** and **15**.

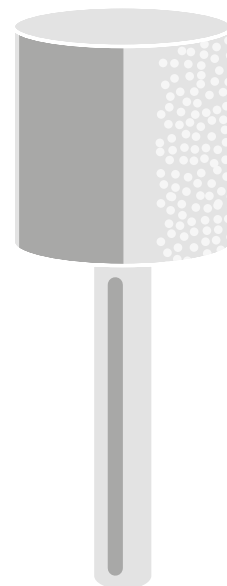

Technical Information

Grit sizes, ISO 525

Coarse	4, 5, 6, 7, 8, 10, 12, 14, 16, 20, 24
Medium	30, 36, 46, 54, 60
Fine	70, 80, 90, 100, 120, 150, 180, 220
Very fine	230, 240, 280, 320, 360, 400, 500

Hardness grade, ISO 525

hardness is a measure of the strength with which the grits are retained by the bond. It is determined by special measuring instruments. The grades are indicated by letter. The hardness increases in alphabetical order.

extreme soft	very soft	soft	medium	hard	very hard	extreme hard
A	E	H	L	P	T	X
B	F	I	M	QU	U	Y
C	G	Jot	N	R	V	Z
D		K	O	S	W	

Structure

The structure of grinding wheels is determined by the ratio of pore volume to the volume of grit and bond. The international standardized structure numbers start with 0 and end with 14.

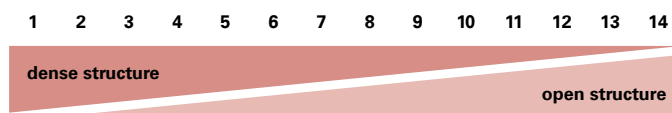

Bond

The bond retains the grit in the grinding wheel. The most important bonds are ISO 525:

Vitrified bond:

V = vitrified bond

The figure behind the bonding code is a company-internal reference.

Organic bonds:

Ba = resin bond

BF = resin bond, reinforced

R = bond or other elastomers

RF = rubber bond, reinforced

Impregnation

The impregnation of vitrified bonds considerably improves the performance of the mounted points when grinding certain steels.

Su = with sulphur

Lu = with resin

W = with wax

F = with grinding oil

Description of Mounted points



Technical Information

Quality

The wide range of abrasive applications, from snagging to polishing, calls for mounted points which meet the requirements of stock removal, surface finish and tool life. The crucial formulation of the mounted point quality results from a combination of the

technical application and selection of the most suitable raw materials. The following tables state the type of raw materials used in LUKAS mounted points.

Grinding, Polishing
(bonded)

Abrasives

NK

★★☆



Aluminum oxide

EKR

★★☆



Aluminum oxide pink

EKW

★★☆

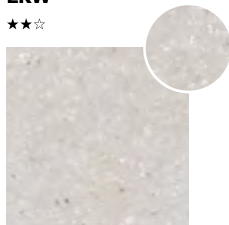

Aluminum oxide white

EKD

★★☆

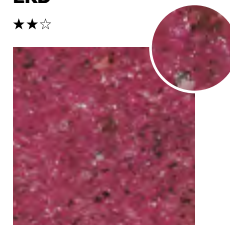

Aluminum oxide dark red

EKbr

★★☆



Standard aluminum oxide pink, type brown

MK

★★☆



Mixture EKR/NK

HK

★★☆



Mixture EKW/NK

HKD

★★☆

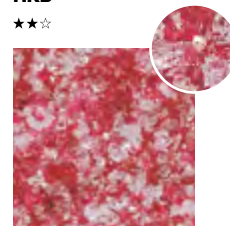

Mixture EKW/EKD

MKD

★★☆



Mixture NK/EKD

RKD

★★☆



Mixture EKD/EKR

SiC-ALU

★★★

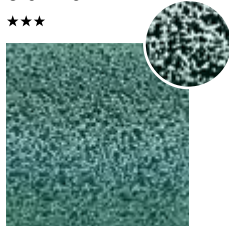

Silicon carbide green

SiCdkl

★★☆

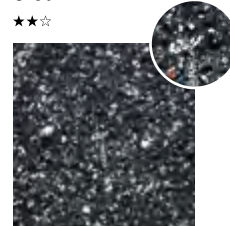

Silicon carbide dark

NDW

★★★



Mixture NK/EKD/EKK white

CERAMIC

★★★

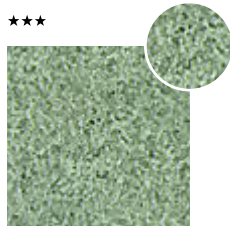

Mixture of ceramic grain and monocrystal aluminium oxide

HOK

★★☆



Mixture spherical aluminium oxide grain

Qualities and areas of application

From the large variety of specifications we have selected various dimensions and shapes in well-proven standard qualities for you. These mounted points are available ex-stock.

Grinding, Polishing (bonded)

	Reference/ Qualities	Cutting speed vc [m/s]	Materials								
			1	2	3	4	5	6	7	8	9
			steels and cast steels	alloyed, tempered steels	tool steels	rust, acid and heat resistant steels and cast steels	cast iron	aluminium, magnesium and copper alloys	Titanium and nickel alloys	plastics, wood, rubber	glass, carbides
	EKR aluminium oxide pink	ca. 20 – 35	best suitable	best suitable	best suitable						
	EKWbr aluminium oxide white, type brown	ca. 25 – 40	best suitable	best suitable							
	RKD mixture aluminium oxide deep red / aluminium oxide pink	ca. 30 – 50		best suitable	best suitable	best suitable					
	NK-BA soft aluminium oxide resin bonded iron and sulphur free	ca. 40 – 50		best suitable	best suitable	best suitable		best suitable			
	NK-BA hard aluminium oxide resin bonded	ca. 40 – 50		best suitable	best suitable						
	HK mixture aluminium oxide white / aluminium oxide	ca. 40 – 50				best suitable	best suitable				
	MK mixture aluminium oxide pink / aluminium oxide	ca. 30 – 50		best suitable		best suitable	best suitable				
	NDW mixture aluminium oxide, aluminium oxide dark red and monocrystal aluminium oxide white	ca. 10 – 30		best suitable	best suitable						
	CERAMIC Mixture of ceramic grain and monocrystal aluminium oxide	ca. 30 – 50			best suitable			best suitable		best suitable	
	EKW aluminium oxide white	ca. 20 – 35			best suitable			best suitable		best suitable	
	EKbr aluminium oxide pink, type brown	ca. 40 – 50		best suitable	best suitable						
	SiC-ALU silicon carbide green	ca. 25 – 40						best suitable			
	HOK mixture spherical aluminium oxide grain	ca. 5 – 20							best suitable		

These quality recommendations only apply when optimum application conditions are used.

Speeds for grinding tools

		Recommended cutting speed v_c [m/s]							
		5	10	20	30	40	50	63	80
		Rotational speed [min-1]							
Tool-diameter [mm]	2	47.700	95.500	191.000	286.500	382.000	477.500	601.600	763.900
	3	31.800	63.700	127.300	191.000	254.600	318.300	401.100	509.300
	4	23.900	47.700	95.500	143.200	191.000	238.700	300.800	382.000
	5	19.100	38.200	76.400	114.600	152.800	191.000	240.600	305.600
	6	15.900	31.800	63.700	95.500	127.300	159.200	200.500	254.600
	8	11.900	23.900	47.700	71.600	95.500	119.400	150.400	191.000
	10	9.500	19.100	38.200	57.300	76.400	95.500	120.300	152.800
	13	7.300	14.700	29.400	44.100	58.800	73.500	92.600	117.500
	20	4.800	9.500	19.100	28.600	38.200	47.700	60.200	76.400
	25	3.800	7.600	15.300	22.900	30.600	38.200	48.100	61.100
	32	3.000	6.000	11.900	17.900	23.900	29.800	37.600	47.700
	40	2.400	4.800	9.500	14.300	19.100	23.900	30.100	38.200
	50	1.900	3.800	7.600	11.500	15.300	19.100	24.100	30.600
	60	1.600	3.200	6.400	9.500	12.700	15.900	20.100	25.500
	80	1.200	2.400	4.800	7.200	9.500	11.900	15.000	19.100
100	1.000	1.900	3.800	5.700	7.600	9.500	12.000	15.300	

Grinding, Polishing (bonded)



Safety instructions

Grinding, Polishing (bonded)

Multilingual product description	<p>Schleifkörper keramisch Brousici tělíska keramická Mounted points - vitrified Muelas cerámicas Meules vitrifiées Sciernice spojone ceramiczne</p>	 ★★★☆☆	Product lines								
Product number and product specification	<p>A200002032602 ZY 2032.06 EKR 36 N V4</p>	<p>Menge / VPE 20</p>	Quantity Safety standard								
Technical information	<table border="1"> <thead> <tr> <th>L_o(mm)</th> <th>max. rpm</th> </tr> </thead> <tbody> <tr> <td>10</td> <td>40.600</td> </tr> <tr> <td>15</td> <td>34.500</td> </tr> <tr> <td>20</td> <td>29.700</td> </tr> </tbody> </table> <p>LUKAS-ERZETT Vereinigte Schleif- und Fräswerkzeugfabriken GmbH & Co. KG Gebrüder-Lukas-Straße 1 - 51788 Engelskirchen Made in Germany</p>	L _o (mm)	max. rpm	10	40.600	15	34.500	20	29.700	<p>FA1488310</p> <p>4 827497 813296</p>	Serial number EAN-Code
L _o (mm)	max. rpm										
10	40.600										
15	34.500										
20	29.700										

Peripheral speeds, safety

Our mounted points are manufactured with state of the art technology for high peripheral speed and the safety is well in accordance with the EN 12413.

We produce mounted points, vitrified and resin bonded, for a maximum peripheral operating speed of 50 m/s.

This maximum operating speed is limited by the following criteria:







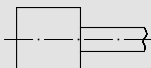
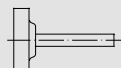
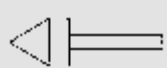
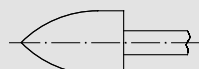
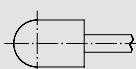
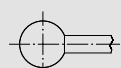
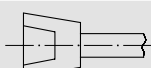

1. The mass (weight) of the mounted point
2. The shape of the mounted point
3. The shank diameter
4. The overhang of the shank
5. The shank material
6. The run-out of the mounted point

The safety aspect of a grinding wheel is of paramount importance. When using and storing Mounted points, note must be taken without fail of the safety-regulations and regulations for prevention of accidents, including the FEPA-safety recommendations.

We enclose a safety ticket with all our deliveries, as illustrated above. The maximum speeds shown on these safety tickets refer to the overhang length (open shank length) of the shank i.e. 10, 15 and 20 mm respectively.

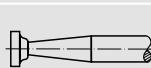
No raw materials used in our grinding wheels are a hazard to health and safety.

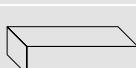
A summary of available shapes

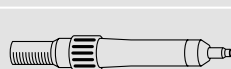
Shape	Type	Shape (Lukas)	Page
	Cylindrical, type 1	ZY	104
	Cylindrical, type 2	ZY2	111
	Cylindrical pointed nose	WKS	112
	Arch pointed nose	SP	113
	Spherical	WR	114
	Cylindrical round nose	KU	115
	Cup	TO	117
	Conical round nose	KE	117
	American shapes	A	119
	American shapes	B	120
	Miniature mounted points	D	120
	Taper sided grinding wheel	SE4	123
	Handstones	–	124
	Mounted points, assortments	–	125
	Power Tools	–	369

Qualities

Grinding, Polishing
(bonded)

EKR

★★☆



aluminium oxide pink

EKWbr

★★☆

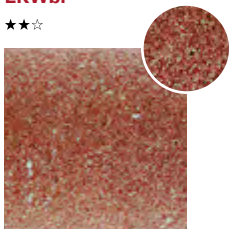

aluminium oxide white,
type brown



General Information

Properties of workpiece material:	Mounted points in various qualities are needed to cover the wide spectrum of the numerous steel types and their resulting workpieces.	
Industries	<ul style="list-style-type: none"> • Machine tools • Automotive • Toolbuilding 	<ul style="list-style-type: none"> • Vessel manufacturers • Shipyards • and many more
Examples of application:	<ul style="list-style-type: none"> • General rough grinding • Fettling • Rough grinding of weld seams 	<ul style="list-style-type: none"> • Finish grinding of weld seams • Deburring
LUKAS grinding tools:	The wide selection of LUKAS-grinding tools incorporates numerous shapes, sizes and qualities. You will find the correct tool from our standard range to solve most grinding problems irrespective of material to be ground, type of machine or any other influencing factors. These mounted points are designed for high stock removal and long tool life.	

Qualities



RKD

★★☆

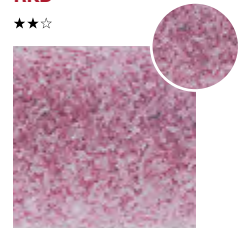

mixture aluminium oxide deep red / aluminium oxide pink

NK-BA-soft

★★☆



aluminium oxide resin bonded iron and sulphur free

Grinding, Polishing (bonded)

General Information

Properties of workpiece material:	Alloyed steels i.e., non-rusting steels are included in the materials which are difficult to machine. They tend to “smear” due to the nickel content, and as a result of poor heat dissipation cause overheating of the material within the grinding contact zone.		
Industries	<ul style="list-style-type: none"> • Steel construction and fabrication (façades, handrails, sanitary equipment) • Vessel manufacturing 	<ul style="list-style-type: none"> • Casings and panelling • Medical technology • Shipyards 	<ul style="list-style-type: none"> • Food industry • and many more
Examples of application:	<ul style="list-style-type: none"> • Rough and finish grinding • Deburring • Fettling 	<ul style="list-style-type: none"> • Removing weld seams • Surface finishing 	
LUKAS grinding tools:	LUKAS has developed particular high performance qualities for alloyed steels distinguished by exceptional stock removal despite operating under difficult conditions. These tools contain no iron, no sulphur and no halogens; a chemical reaction (corrosion) of the workpiece material in the grinding contact zone is therefore generally avoided.		

Qualities

Grinding, Polishing
(bonded)

NK Ba-hard

★★☆

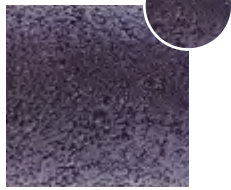

aluminium oxide resin bonded

MK

★★☆

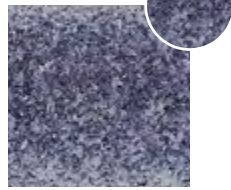

mixture aluminium oxide pink / aluminium oxide

HK

★★☆



mixture aluminium oxide white / aluminium oxide



General Information

Properties of workpiece material:	The characteristics of the various types of cast materials are normally determined by their carbon content, and the way in which the carbon is removed from the material structure. Cast components are generally “rough” machined. The skin contains inclusions of sand from the casting process; large burrs, runners and risers, holes and cracks must all be removed by grinding. These areas to be ground are often somewhat inaccessible.
Industries	<ul style="list-style-type: none"> • Manufacturers of cast components i.e., engine blocks, gear box casings, cylinder heads, frames, stands, machine slides, gears, crankshafts, pump and turbine housings, machine tool components • and many more
Examples of application:	<ul style="list-style-type: none"> • Deburring • Fettingling • Polishing • Finish grinding of repair welds • Removing holes and cracks
LUKAS grinding tools:	The LUKAS mounted points specifically formulated to grind cast materials contain special grain combinations and tough bonding systems; such qualities give optimum performance for the applications mentioned above. The aggressiveness of the abrasive grain and the smooth running of the mounted points allow for an ergonomic method of machining requiring minimum force. Mounted points with specially extended shafts are also available on request.

Qualities



NDW

★★★

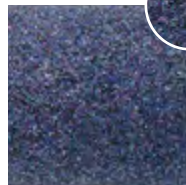

mixture aluminium oxide, aluminium oxide dark red and monocrystal aluminium oxide white

CERAMIC

★★★

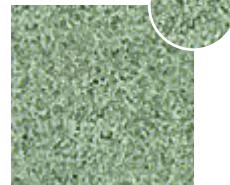

Mixture of ceramic grain and monocrystal aluminium oxide

EKbr

★★☆



aluminium oxide pink, type brown

EKW

★★☆

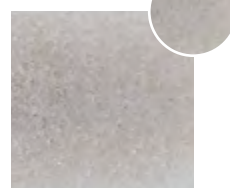

aluminium oxide white

General Information

Properties of workpiece material:	Precision is a major factor in the tool and mould industry. Tool steels are selected with the appropriate hardness and toughness to suit the application; special mounted point qualities are therefore essential to achieve the tight tolerances required.		
Industries	<ul style="list-style-type: none"> • Toolmakers • Pattern shops • Mould manufacturers 	<ul style="list-style-type: none"> • Aerospace 	
Examples of application:	<ul style="list-style-type: none"> • Re-grinding • Groove grinding • Fine deburring 	<ul style="list-style-type: none"> • Finish grinding • Lapping • Coordinate grinding 	<ul style="list-style-type: none"> • Ball bearing grinding • Turbine blades
LUKAS grinding tools:	LUKAS mounted points for tool and mould-making are extremely dimensionally stable and can cut even the hardest materials. Ceramic abrasive grit is extremely friable due to its microcrystal structure. This makes it self-sharpening. Therefore, materials which are difficult to cut (e.g. nickel-based alloys) can be machined without any problems. Moreover, the use of special grain qualities ensures a long service life. Moreover, the use of special grain qualities ensures a long service life.		

Qualities

Grinding, Polishing
(bonded)

SIC-ALU

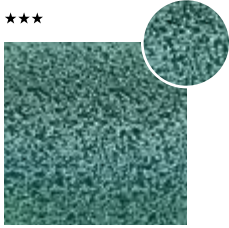

silicon carbide green



General Information

Properties of workpiece material:	Aluminium and its associated alloys have many varied and positive characteristics making it the second most widely used metal after steel. Aluminium has only 1/3 the density of steel. The purer the metal, the weaker it becomes but allows for better shape forming. Unsuitable mounted point qualities are often used which "load".		
Industries	<ul style="list-style-type: none"> • Transport (railways, ships, automotive, aerospace) • Metal construction (bridges, cranes, silos) 	<ul style="list-style-type: none"> • Apparatus engineering • Chemical industry (vessels, pumps, pipes) 	<ul style="list-style-type: none"> • Engine, transmission parts • and many more
Examples of application:	<ul style="list-style-type: none"> • Deburring • Fettingling 	<ul style="list-style-type: none"> • Re-working • Surface finishing 	
LUKAS grinding tools:	The LUKAS mounted points in the quality SIC – ALU have been developed solely for this application. Due to a special structure, maximum tool life is achieved whilst preventing "loading" of material within the pores. The self-dressing effect is aided by the use of a special impregnation.		

Qualities



HOK

★★☆



mixture spherical
aluminium oxide grain

General Information

Properties of workpiece material:	Materials such as rubber or plastic are very elastic and have a very low melting point. They flex and generate heat; this often results in a bad odour and loading.	
Industries	<ul style="list-style-type: none"> • Machining rubber • Machining plastic 	
Examples of application:	<ul style="list-style-type: none"> • Tyre repair and re-vulcanizing • Repair of conveyor belts 	<ul style="list-style-type: none"> • Preparation of various areas for adhesion • Deburring of rubber or plastic components
LUKAS grinding tools:	LUKAS abrasive tools for the machining of rubber and plastic contain a special spherical grain (HOK) in a very open ceramic structure. This abrasive media creates permanent small razor-sharp cutting edges which pluck-out the material from the surface. Consequently, these tools are ideally suited for the machining applications as illustrated.	

Shape ZY, Cylinder, Type 1 (according to DIN 69170)



Grinding, Polishing
(bonded)

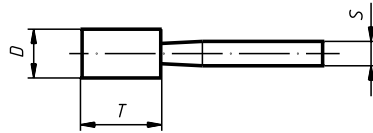

Ordering example: A200000205377

Further dimensions, qualities and shank lengths on request.

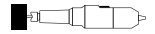

PG 3

Product number	Description	Quality	D mm	T mm	S mm	recommended for Information on page 438		
A200000205377	ZY 0205.03	CERAMIC 80 L V118	2	5	3 x 30	② ③ ④ ⑦	■	20
A200000306377	ZY 0306.03	CERAMIC 80 L V118	3	6	3 x 30	② ③ ④ ⑦	■	20
A200000408377	ZY 0408.03	CERAMIC 80 L V118	4	8	3 x 30	② ③ ④ ⑦	■	20
A200000510377	ZY 0510.03	CERAMIC 80 L V118	5	10	3 x 30	② ③ ④ ⑦	■	20
A200000613377	ZY 0613.03	CERAMIC 80 L V118	6	13	3 x 30	② ③ ④ ⑦	■	20
A200001020677	ZY 1020.06	CERAMIC 80 L V118	10	20	6 x 40	② ③ ④ ⑦	■	20
A200001325677	ZY 1325.06	CERAMIC 46 L V118	13	25	6 x 40	② ③ ④ ⑦	■	20
A200001632677	ZY 1632.06	CERAMIC 46 L V118	16	32	6 x 40	② ③ ④ ⑦	■	20
A200002032677	ZY 2032.06	CERAMIC 46 L V118	20	32	6 x 40	② ③ ④ ⑦	■	20

Shape ZY, Cylinder, Type 1 (according to DIN 69170)

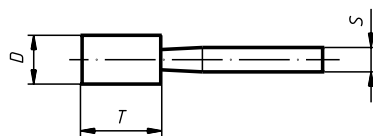

Ordering example: A200000306353

Further dimensions, qualities and shank lengths on request.



PG 3

Product number	Description	Quality	D mm	T mm	S mm	recommended for Information on page 438		
A200000306353	ZY 0306.03	NDW 100 QU V115	3	6	3 x 50	② ③	■	20
A2000003063530001	ZY 0306.03	NDW 100 QU V115	3	6	3 x 30	② ③	■	20
A200000408353	ZY 0408.03	NDW 100 QU V115	4	8	3 x 50	② ③	■	20
A2000004083530001	ZY 0408.03	NDW 100 QU V115	4	8	3 x 30	② ③	■	20
A200000610353	ZY 0610.03	NDW 100 QU V115	6	10	3 x 50	② ③	■	20
A2000006103530001	ZY 0610.03	NDW 100 QU V115	6	10	3 x 30	② ③	■	20
A200000810353	ZY 0810.03	NDW 100 QU V115	8	10	3 x 50	② ③	■	20
A2000008103530001	ZY 0810.03	NDW 100 QU V115	8	10	3 x 30	② ③	■	20
A200001013353	ZY 1013.03	NDW 100 QU V115	10	13	3 x 50	② ③	■	20
A2000010133530001	ZY 1013.03	NDW 100 QU V115	10	13	3 x 30	② ③	■	20

Shape ZY, Cylinder, Type 1 (according to DIN 69170)



Grinding, Polishing
(bonded)

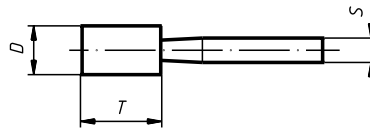

Ordering example: A200000104302

Further dimensions, qualities and shank lengths on request.

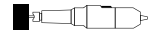

PG 3

Product number	Description	Quality	D mm	T mm	S mm	recommended for Information on page 438			
A200000104302	ZY 0104.03	EKR 150 N V4	1,5	4	3 x 30	① ② ③			■ 20
A200000104347	ZY 0104.03	RKD 150 QU V21	1,5	4	3 x 30	② ③ ④			■ 20
A200000205302	ZY 0205.03	EKR 120 N V4	2	5	3 x 30	① ② ③			■ 20
A200000205312	ZY 0205.03	EKWBR 120 O/P V7	2	5	3 x 30	① ②			■ 20
A200000205347	ZY 0205.03	RKD 150 QU V21	2	5	3 x 30	② ③ ④			■ 20
A200000205602	ZY 0205.06	EKR 120 N V4	2	5	6 x 40	① ② ③			■ 20
A200000205647	ZY 0205.06	RKD 150 QU V21	2	5	6 x 40	② ③ ④			■ 20
A2000002053020001	ZY 0305.03	EKR 120 N V4	2,5	5	3 x 30	① ② ③			■ 20
A200000306302	ZY 0306.03	EKR 100 N V4	3	6	3 x 30	① ② ③			■ 20
A2000003063020001	ZY 0306.03	EKR 120 QU V4	3	6	3 x 30	① ② ③			■ 20
A200000306312	ZY 0306.03	EKWBR 100 O/P V7	3	6	3 x 30	① ②			■ 20
A200000306347	ZY 0306.03	RKD 120 QU V21	3	6	3 x 30	② ③ ④			■ 20
A200000306602	ZY 0306.06	EKR 100 N V4	3	6	6 x 40	① ② ③			■ 20
A200000306647	ZY 0306.06	RKD 120 QU V21	3	6	6 x 40	② ③ ④			■ 20
A200000408302	ZY 0408.03	EKR 80 N V4	4	8	3 x 30	① ② ③			■ 20
A2000004083020001	ZY 0408.03	EKR 100 QU V4	4	8	3 x 30	① ② ③			■ 20
A200000408312	ZY 0408.03	EKWBR 80 O/P V7	4	8	3 x 30	① ②			■ 20
A200000408347	ZY 0408.03	RKD 100 QU V21	4	8	3 x 30	② ③ ④			■ 20
A200000408602	ZY 0408.06	EKR 80 N V4	4	8	6 x 40	① ② ③			■ 20
A200000408647	ZY 0408.06	RKD 100 QU V21	4	8	6 x 40	② ③ ④			■ 20
A200000510302	ZY 0510.03	EKR 80 N V4	5	10	3 x 30	① ② ③			■ 20
A2000005103020001	ZY 0510.03	EKR 80/100 QU V4	5	10	3 x 30	① ② ③			■ 20
A200000510312	ZY 0510.03	EKWBR 80 O/P V7	5	10	3 x 30	① ②			■ 20
A200000510347	ZY 0510.03	RKD 100 QU V21	5	10	3 x 30	② ③ ④			■ 20
A200000510602	ZY 0510.06	EKR 80 N V4	5	10	6 x 40	① ② ③			■ 20
A200000510647	ZY 0510.06	RKD 100 QU V21	5	10	6 x 40	② ③ ④			■ 20
A200000610302	ZY 0610.03	EKR 60 N V4	6	10	3 x 30	① ② ③			■ 20
A200000610312	ZY 0610.03	EKWBR 60 O/P V7	6	10	3 x 30	① ②			■ 20
A200000610347	ZY 0610.03	RKD 80 QU V21	6	10	3 x 30	② ③ ④			■ 20
A200000610602	ZY 0610.06	EKR 60 N V4	6	10	6 x 40	① ② ③			■ 20
A200000610608	ZY 0610.06	EKW 80 L V1	6	10	6 x 40	③	⑦	⑨	■ 20
A200000610647	ZY 0610.06	RKD 80 QU V21	6	10	6 x 40	② ③ ④			■ 20
A200000810302	ZY 0810.03	EKR 60 N V4	8	10	3 x 30	① ② ③			■ 20
A2000008103020001	ZY 0810.03	EKR 60/80 QU V4	8	10	3 x 30	① ② ③			■ 20
A200000810312	ZY 0810.03	EKWBR 60 O/P V7	8	10	3 x 30	① ②			■ 20
A200000810347	ZY 0810.03	RKD 80 QU V21	8	10	3 x 30	② ③ ④			■ 20
A200000810602	ZY 0810.06	EKR 60 N V4	8	10	6 x 40	① ② ③			■ 20

Shape ZY, Cylinder, Type 1 (according to DIN 69170)

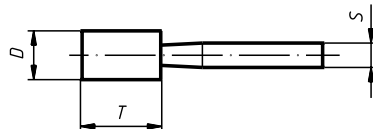

Ordering example: A200000104302

Further dimensions, qualities and shank lengths on request.



Grinding, Polishing (bonded)



PG 3

Product number	Description	Quality	D mm	T mm	S mm	recommended for Information on page 438						
A200000810608	ZY 0810.06	EKW 80 L V1	8	10	6 x 40		③		⑦	⑨	■	20
A200000810647	ZY 0810.06	RKD 80 QU V21	8	10	6 x 40		② ③ ④				■	20
A200000816302	ZY 0816.03	EKR 60 N V4	8	16	3 x 30	① ② ③					■	20
A200000816312	ZY 0816.03	EKWBR 60 O/P V7	8	16	3 x 30	① ②					■	20
A200000816347	ZY 0816.03	RKD 80 QU V21	8	16	3 x 30		② ③ ④				■	20
A200000816602	ZY 0816.06	EKR 60 N V4	8	16	6 x 40	① ② ③					■	20
A200000816647	ZY 0816.06	RKD 80 QU V21	8	16	6 x 40		② ③ ④				■	20
A200000820602	ZY 0820.06	EKR 60 N V4	8	20	6 x 40	① ② ③					■	20
A200001010302	ZY 1010.03	EKR 60 N V4	10	10	3 x 30	① ② ③					■	20
A2000010103020001	ZY 1010.03	EKR 60/80 QU V4	10	10	3 x 30	① ② ③					■	20
A200001010312	ZY 1010.03	EKWBR. 60 O/P V7	10	10	3 x 30	① ②					■	20
A200001010347	ZY 1010.03	RKD 80 P V21	10	10	3 x 30		② ③ ④				■	20
A200001010602	ZY 1010.06	EKR 60 N V4	10	10	6 x 40	① ② ③					■	20
A200001010608	ZY 1010.06	EKW 60 L V1	10	10	6 x 40		③		⑦	⑨	■	20
A200001010647	ZY 1010.06	RKD 80 P V21	10	10	6 x 40		② ③ ④				■	20
A200001013302	ZY 1013.03	EKR 60 N V4	10	13	3 x 30	① ② ③					■	20
A200001013312	ZY 1013.03	EKWBR 60 O/P V7	10	13	3 x 30	① ②					■	20
A200001013602	ZY 1013.06	EKR 60 N V4	10	13	6 x 40	① ② ③					■	20
A200001020602	ZY 1020.06	EKR 60 N V4	10	20	6 x 40	① ② ③					■	20
A2000010206020001	ZY 1020.06	EKR 46 QU V4	10	20	6 x 40	① ② ③					■	20
A200001020612	ZY 1020.06	EKWBR 60 O/P V7	10	20	6 x 40	① ②					■	20
A200001020616	ZY 1020.06	MK 46 N V10	10	20	6 x 40		②		④ ⑤		■	20
A200001020627	ZY 1020.06	NK 46 QU BA hard	10	20	6 x 40		② ③		⑤		■	20
A200001032602	ZY 1032.06	EKR 60 N V4	10	32	6 x 40	① ② ③					■	20
A2000010326020001	ZY 1032.06	EKR 46 QU V4	10	32	6 x 40	① ② ③					■	20
A200001032612	ZY 1032.06	EKWBR 60 O/P V7	10	32	6 x 40	① ②					■	20
A200001032627	ZY 1032.06	NK 46 QU BA hard	10	32	6 x 40		② ③		⑤		■	20
A200001040602	ZY 1040.06	EKR 60 N V4	10	40	6 x 40	① ② ③					■	20
A200001040627	ZY 1040.06	NK 46 QU BA hard	10	40	6 x 40		② ③		⑤		■	20
A200001313302	ZY 1313.03	EKR 46 N V4	13	13	3 x 30	① ② ③					■	20
A200001313312	ZY 1313.03	EKWBR 60 O/P V7	13	13	3 x 30	① ②					■	20
A200001313347	ZY 1313.03	RKD 60 P (6) V21	13	13	3 x 30		② ③ ④				■	20
A200001313602	ZY 1313.06	EKR 46 N V4	13	13	6 x 40	① ② ③					■	20
A200001313647	ZY 1313.06	RKD 60 P (6) V21	13	13	6 x 40		② ③ ④				■	20
A200001320602	ZY 1320.06	EKR 46 N V4	13	20	6 x 40	① ② ③					■	20
A2000013206020001	ZY 1320.06	EKR 46 QU V4	13	20	6 x 40	① ② ③					■	20
A200001320612	ZY 1320.06	EKWBR 60 O/P V7	13	20	6 x 40	① ②					■	20

Shape ZY, Cylinder, Type 1 (according to DIN 69170)



Grinding, Polishing
(bonded)

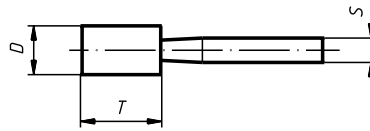

Ordering example: A20000104302

Further dimensions, qualities and shank lengths on request.

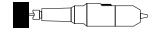

PG 3

Product number	Description	Quality	D mm	T mm	S mm	recommended for Information on page 438										PG 3			
A200001320616	ZY 1320.06	MK 46 N V10	13	20	6 x 40		②		④	⑤								■	20
A200001320627	ZY 1320.06	NK 46 QU BA hard	13	20	6 x 40		②	③		⑤								■	20
A200001325602	ZY 1325.06	EKR 46 N V4	13	25	6 x 40	①	②	③										■	20
A200001325647	ZY 1325.06	RKD 60 QU V21	13	25	6 x 40		②	③	④									■	20
A200001332602	ZY 1332.06	EKR 46 N V4	13	32	6 x 40	①	②	③										■	20
A200001332627	ZY 1332.06	NK 46 QU BA hard	13	32	6 x 40		②	③		⑤								■	20
A200001332627W	ZY 1332.06	NK 24 N BA soft	13	32	6 x 40		②	③	④		⑥							■	20
A200001616602	ZY 1616.06	EKR 46 N V4	16	16	6 x 40	①	②	③										■	20
A200001616647	ZY 1616.06	RKD 36 O (6) V21	16	16	6 x 40		②	③	④									■	20
A200001620602	ZY 1620.06	EKR 46 N V4	16	20	6 x 40	①	②	③										■	20
A200001620612	ZY 1620.06	EKWBR 46 O/P V7	16	20	6 x 40	①	②											■	20
A200001620627	ZY 1620.06	NK 24 QU BA hard	16	20	6 x 40		②	③		⑤								■	20
A200001632602	ZY 1632.06	EKR 46 N V4	16	32	6 x 40	①	②	③										■	20
A200001632612	ZY 1632.06	EKWBR 46 O/P V7	16	32	6 x 40	①	②											■	20
A200001632616	ZY 1632.06	MK 36 N V10	16	32	6 x 40		②		④	⑤								■	20
A200001632627	ZY 1632.06	NK 24 QU BA hard	16	32	6 x 40		②	③		⑤								■	20
A200001632627W	ZY 1632.06	NK 24 N BA soft	16	32	6 x 40		②	③	④		⑥							■	20
A200001632633	ZY 1632.06	HK 30 N V13	16	32	6 x 40				④	⑤								■	20
A200001632647	ZY 1632.06	RKD 36 O (6) V21	16	32	6 x 40		②	③	④									■	20
A200001640602	ZY 1640.06	EKR 46 N V4	16	40	6 x 40	①	②	③										■	20
A200001640616	ZY 1640.06	MK 36 N V10	16	40	6 x 40		②		④	⑤								■	20
A200001640627	ZY 1640.06	NK 24 QU BA hard	16	40	6 x 40		②	③		⑤								■	20
A200002013602	ZY 2013.06	EKR 36 N V4	20	13	6 x 40	①	②	③										■	20
A200002020602	ZY 2020.06	EKR 36 N V4	20	20	6 x 40	①	②	③										■	20
A200002020608	ZY 2020.06	EKW 60 L V1	20	20	6 x 40			③				⑦		⑨				■	20
A200002020616	ZY 2020.06	MK 36 N V10	20	20	6 x 40		②		④	⑤								■	20
A200002020627	ZY 2020.06	NK 24 QU BA hard	20	20	6 x 40		②	③		⑤								■	20
A200002020647	ZY 2020.06	RKD 36 O (6) V21	20	20	6 x 40		②	③	④									■	20
A200002025602	ZY 2025.06	EKR 36 N V4	20	25	6 x 40	①	②	③										■	20
A200002025647	ZY 2025.06	RKD 36 O (6) V21	20	25	6 x 40		②	③	④									■	20
A202202025626	ZY 2025.06	HOK 0-3 V9	20	25	6 x 40									⑧				■	20
A200002032602	ZY 2032.06	EKR 36 N V4	20	32	6 x 40	①	②	③										■	20
A2000020326020001	ZY 2032.06	EKR 30/36 QU (7) V21	20	32	6 x 40	①	②	③										■	20
A200002032616	ZY 2032.06	MK 36 N V10	20	32	6 x 40		②		④	⑤								■	20
A200002032627	ZY 2032.06	NK 24 QU BA hard	20	32	6 x 40		②	③		⑤								■	20
A200002032633	ZY 2032.06	HK 30 N V13	20	32	6 x 40				④	⑤								■	20
A200002032647	ZY 2032.06	RKD 36 O (6) V21	20	32	6 x 40		②	③	④									■	20

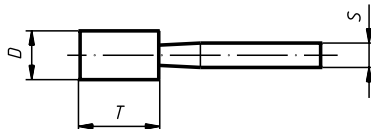
Shape ZY, Cylinder, Type 1 (according to DIN 69170)

Ordering example: A20000104302

Further dimensions, qualities and shank lengths on request.



Grinding - Polishing (bonded)



PG 3

Product number	Description	Quality	D mm	T mm	S mm	recommended for Information on page 438		
A200002040602	ZY 2040.06	EKR 36 N V4	20	40	6 x 40	① ② ③	■	20
A200002040612	ZY 2040.06	EKWBR 46 O/P V7	20	40	6 x 40	① ②	■	20
A200002040616	ZY 2040.06	MK 36 N V10	20	40	6 x 40	② ④ ⑤	■	20
A200002040627	ZY 2040.06	NK 24 QU BA hard	20	40	6 x 40	② ③ ⑤	■	20
A200002040627W	ZY 2040.06	NK 24 N BA soft	20	40	6 x 40	② ③ ④ ⑥	■	20
A200002040633	ZY 2040.06	HK 30 N V13	20	40	6 x 40	④ ⑤	■	20
A200002040647	ZY 2040.06	RKD 36 O (6) V21	20	40	6 x 40	② ③ ④	■	20
A200002040827	ZY 2040.08	NK 24 QU BA hard	20	40	8 x 40	② ③ ⑤	■	20
A200002040827W	ZY 2040.08	NK 24 N BA soft	20	40	8 x 40	② ③ ④ ⑥	■	20
A200002040833	ZY 2040.08	HK 30 N V13	20	40	8 x 40	④ ⑤	■	20
A200002520602	ZY 2520.06	EKR 36 N V4	25	20	6 x 40	① ② ③	■	20
A200002525602	ZY 2525.06	EKR 36 N V4	25	25	6 x 40	① ② ③	■	20
A200002525627	ZY 2525.06	NK 24 QU BA hard	25	25	6 x 40	② ③ ⑤	■	20
A200002525647	ZY 2525.06	RKD 30 O (6) V21	25	25	6 x 40	② ③ ④	■	20
A200002532602	ZY 2532.06	EKR 36 N V4	25	32	6 x 40	① ② ③	■	20
A200002532616	ZY 2532.06	MK 36 N V10	25	32	6 x 40	② ④ ⑤	■	20
A200002532627	ZY 2532.06	NK 24 QU BA hard	25	32	6 x 40	② ③ ⑤	■	20
A200002532627W	ZY 2532.06	NK 24 N BA soft	25	32	6 x 40	② ③ ④ ⑥	■	20
A200002532633	ZY 2532.06	HK 30 N V13	25	32	6 x 40	④ ⑤	■	20
A200002532647	ZY 2532.06	RKD 30 O (6) V21	25	32	6 x 40	② ③ ④	■	20
A200003220602	ZY 3220.06	EKR 30 N V4	32	20	6 x 40	① ② ③	■	20
A200003220616	ZY 3220.06	MK 36 N V10	32	20	6 x 40	② ④ ⑤	■	20
A200003220627	ZY 3220.06	NK 24 QU BA hard	32	20	6 x 40	② ③ ⑤	■	20
A200003232602	ZY 3232.06	EKR 30 N V4	32	32	6 x 40	① ② ③	■	20
A2000032326020001	ZY 3232.06	EKR 30/36 QU (7) V21	32	32	6 x 40	① ② ③	■	20
A200003232612	ZY 3232.06	EKWBR 46 O/P V7	32	32	6 x 40	① ②	■	20
A200003232616	ZY 3232.06	MK 36 N V10	32	32	6 x 40	② ④ ⑤	■	20
A200003232627	ZY 3232.06	NK 24 QU BA hard	32	32	6 x 40	② ③ ⑤	■	20
A200003232627W	ZY 3232.06	NK 24 N BA soft	32	32	6 x 40	② ③ ④ ⑥	■	20
A200003232647	ZY 3232.06	RKD 30 O (6) V21	32	32	6 x 40	② ③ ④	■	20
A200003240602	ZY 3240.06	EKR 30 N V4	32	40	6 x 40	① ② ③	■	20
A200003240616	ZY 3240.06	MK 36 N V10	32	40	6 x 40	② ④ ⑤	■	20
A200003240647	ZY 3240.06	RKD 30 O (6) V21	32	40	6 x 40	② ③ ④	■	20
A200003250827	ZY 3250.08	NK 24 O BA 64	32	50	8 x 40	② ③ ⑤	■	20
A200004020602	ZY 4020.06	EKR 30 N V4	40	20	6 x 40	① ② ③	■	20
A200004020616	ZY 4020.06	MK 36 N V10	40	20	6 x 40	② ④ ⑤	■	20
A200004020627	ZY 4020.06	NK 24 QU BA hard	40	20	6 x 40	② ③ ⑤	■	20

Shape ZY, Cylinder, Type 1 (according to DIN 69170)

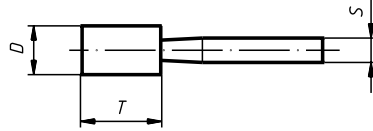

Grinding, Polishing
(bonded)



Ordering example: A200000104302

Further dimensions, qualities and shank lengths on request.

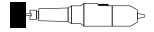

PG 3

Product number	Description	Quality	D mm	T mm	S mm	recommended for Information on page 438		
A200004020627W	ZY 4020.06	NK 24 N BA soft	40	20	6 x 40	② ③ ④ ⑥	■	20
A200004020633	ZY 4020.06	HK 30 N V13	40	20	6 x 40	④ ⑤	■	20
A200004020647	ZY 4020.06	RKD 24 O (6) V21	40	20	6 x 40	② ③ ④	■	20
A200004020827	ZY 4020.08	NK 24 QU BA hard	40	20	8 x 40	② ③ ⑤	■	20
A200004020827W	ZY 4020.08	NK 24 N BA soft	40	20	8 x 40	② ③ ④ ⑥	■	20
A200004020833	ZY 4020.08	HK 30 N V13	40	20	8 x 40	④ ⑤	■	20
A200004020847	ZY 4020.08	RKD 24 O (6) V21	40	20	8 x 40	② ③ ④	■	20
A202204020626	ZY 4020.06	HOK 0-3 V9	40	20	6 x 40	⑧	■	20
A200004025833	ZY 4025.08	HK 24/30 P V4	40	25	8 x 40	④ ⑤	■	20
A200004040602	ZY 4040.06	EKR 30 N V4	40	40	6 x 40	① ② ③	■	20
A200004040647	ZY 4040.06	RKD 24 O (6) V21	40	40	6 x 40	② ③ ④	■	20
A200004040816	ZY 4040.08	MK 36 N V10	40	40	8 x 40	② ④ ⑤	■	20
A200004040827	ZY 4040.08	NK 24 QU BA hard	40	40	8 x 40	② ③ ⑤	■	20
A200004040847	ZY 4040.08	RKD 24 O (6) V21	40	40	8 x 40	② ③ ④	■	20
A200005013827	ZY 5013.08	NK 24 QU BA hard	50	13	8 x 40	② ③ ⑤	■	20
A200005020602	ZY 5020.06	EKR 30 N V4	50	20	6 x 40	① ② ③	■	20
A200005020627	ZY 5020.06	NK 24 QU BA hard	50	20	6 x 40	② ③ ⑤	■	20
A200005020627W	ZY 5020.06	NK 24 N BA soft	50	20	6 x 40	② ③ ④ ⑥	■	20
A200005020647	ZY 5020.06	RKD 24 O (6) V21	50	20	6 x 40	② ③ ④	■	20
A200005020827	ZY 5020.08	NK 24 QU BA hard	50	20	8 x 40	② ③ ⑤	■	20
A200005025616	ZY 5025.06	MK 30 N V10	50	25	6 x 40	② ④ ⑤	■	20
A200005025827	ZY 5025.08	NK 24 QU BA hard	50	25	8 x 40	② ③ ⑤	■	20

Shape ZY, Cylinder, Type 2 (according to DIN 69170)

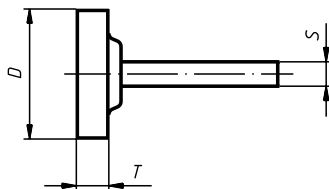

Ordering example: A201301303377

Further dimensions, qualities and shank lengths on request.



PG 3

Product number	Description	Quality	D mm	T mm	S mm	recommended for Information on page 438		
A201301303377	ZY2 1303.03	CERAMIC 80 LV118	13	3	3 x 30	② ③ ④ ⑦	■	20

Shape ZY, Cylinder, Type 2 (according to DIN 69170)

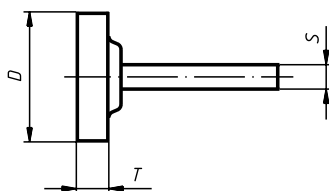

Ordering example: A201301303302

Further dimensions, qualities and shank lengths on request.



PG 3

Product number	Description	Quality	D mm	T mm	S mm	recommended for Information on page 438		
A201301303302	ZY2 1303.03	EKR 80 N V4	13	3	3 x 30	① ② ③	■	20
A201301303312	ZY2 1303.03	EKWBR 80 O/P V7	13	3	3 x 30	① ②	■	20
A201301303347	ZY2 1303.03	RKD 80 QU V21	13	3	3 x 30	② ③ ④	■	20
A201301303602	ZY2 1303.06	EKR 80 N V4	13	3	6 x 40	① ② ③	■	20
A201301604302	ZY2 1604.03	EKR 60 N V4	16	4	3 x 30	① ② ③	■	20
A201301604312	ZY2 1604.03	EKWBR 60 O/P V7	16	4	3 x 30	① ②	■	20
A201301604347	ZY2 1604.03	RKD 80 QU V21	16	4	3 x 30	② ③ ④	■	20
A201301604602	ZY2 1604.06	EKR 60 N V4	16	4	6 x 40	① ② ③	■	20
A201302006302	ZY2 2006.03	EKR 60 N V4	20	6	3 x 30	① ② ③	■	20
A201302006312	ZY2 2006.03	EKWBR 60 O/P V7	20	6	3 x 30	① ②	■	20
A201302006602	ZY2 2006.06	EKR 60 N V4	20	6	6 x 40	① ② ③	■	20
A2013020066020001	ZY2 2006.06	EKR 46 QU V4	20	6	6 x 40	① ② ③	■	20
A201302506602	ZY2 2506.06	EKR 60 N V4	25	6	6 x 40	① ② ③	■	20
A201302506627	ZY2 2506.06	NK 24 N BA soft	25	6	6 x 40	② ③ ④ ⑥	■	20
A201302510602	ZY2 2510.06	EKR 36 N V4	25	10	6 x 40	① ② ③	■	20
A201302510627	ZY2 2510.06	NK 24 QU BA hard	25	10	6 x 40	② ③ ⑤	■	20
A201303208602	ZY2 3208.06	EKR 46 N V4	32	8	6 x 40	① ② ③	■	20
A201303208627	ZY2 3208.06	NK 24 QU BA hard	32	8	6 x 40	② ③ ⑤	■	20
A201303208647	ZY2 3208.06	RKD 36 O (6) V21	32	8	6 x 40	② ③ ④	■	20

Shape ZY, Cylinder, Type 2 (according to DIN 69170)



Grinding, Polishing
(bonded)

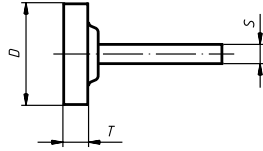

Ordering example: A201301303302

Further dimensions, qualities and shank lengths on request.

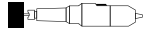

PG 3

Product number	Description	Quality	D mm	T mm	S mm	recommended for Information on page 438			
A201304006627	ZY2 4006.06	NK 24 N BA soft	40	10	6 x 40	② ③ ④ ⑥	■		20
A201304010602	ZY2 4010.06	EKR 30 N V4	40	10	6 x 40	① ② ③	■		20
A201304010616	ZY2 4010.06	MK 36 N V10	40	10	6 x 40	② ④ ⑤	■		20
A201304010627	ZY2 4010.06	NK 24 QU BA hard	40	10	6 x 40	② ③ ⑤	■		20
A201304010627W	ZY2 4010.06	NK 24 N BA soft	40	10	6 x 40	② ③ ④ ⑥	■		20
A201304010647	ZY2 4010.06	RKD 30 O (6) V21	40	10	6 x 40	② ③ ④	■		20
A201305004627	ZY2 5004.06	NK 24 QU BA hard	50	4	6 x 40	② ③ ⑤	■		20
A201305004627W	ZY2 5004.06	NK 24 N BA soft	50	4	6 x 40	② ③ ④ ⑥	■		20
A201305006627	ZY2 5006.06	NK 24 QU BA hard	50	6	6 x 40	② ③ ⑤	■		20
A201305006627W	ZY2 5006.06	NK 24 N BA soft	50	6	6 x 40	② ③ ④ ⑥	■		20
A201305010602	ZY2 5010.06	EKR 30 N V4	50	10	6 x 40	① ② ③	■		20
A201305010627	ZY2 5010.06	NK 24 QU BA hard	50	10	6 x 40	② ③ ⑤	■		20
A201305010627W	ZY2 5010.06	NK 24 N BA soft	50	10	6 x 40	② ③ ④ ⑥	■		20
A201305010633	ZY2 5010.06	HK 30 N V13	50	10	6 x 40	④ ⑤	■		20
A201305010827	ZY2 5010.08	NK 24 QU BA hard	50	10	8 x 40	② ③ ⑤	■		20
A6013060066270005	ZY2 6006.06	NK 24 QU BA hard	60	6	6 x 40	② ③ ⑤	■		20
A201306510827	ZY2 6510.08	NK 24 P BA.15	65	10	8 x 40	② ③ ⑤	■		20
A201307510827	ZY2 7510.08	NK 24 QU BA.64	75	10	8 x 40	② ③ ⑤	■		20

Shape WKS, Cylindrical pointed nose

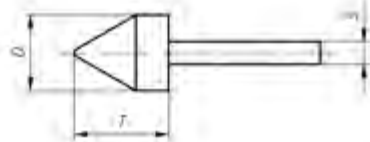

Ordering example: A200402025602

Further dimensions, qualities and shank lengths on request.



PG 3

Product number	Description	Quality	D mm	T mm	S mm	recommended for Information on page 438			
A200402025602	WKS 2025.06	EKR 60 N V4	20	25	6 x 40	① ② ③	■		20

Shape SP, Arch pointed nose (according to DIN 69170)



★★★

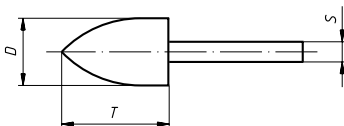

Ordering example: A200200306377

Further dimensions, qualities and shank lengths on request.



Grinding, Polishing (bonded)



PG 3

Product number	Description	Quality	D mm	T mm	S mm	recommended for										PG 3	Information on page 438		
						②	③	④	⑤	⑥	⑦	⑧	⑨	⑩	⑪				⑫
A200200306377	SP 0306.03	CERAMIC 80 L V118	3	6	3 x 30		②	③	④						⑦			■	20
A200200510377	SP 0510.03	CERAMIC 80 L V118	5	10	3 x 30		②	③	④						⑦			■	20
A200200816377	SP 0816.03	CERAMIC 80 L V118	8	16	3 x 30		②	③	④						⑦			■	20
A200201320677	SP 1320.06	CERAMIC 80 L V118	13	20	6 x 40		②	③	④						⑦			■	20

Shape SP, Pointed nose (according to DIN 69170)



★★★

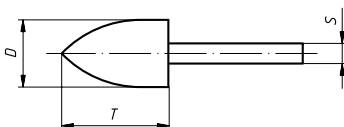

Ordering example: A200200510353

Further dimensions, qualities and shank lengths on request.



PG 3

Product number	Description	Quality	D mm	T mm	S mm	recommended for										PG 3	Information on page 438		
						②	③	④	⑤	⑥	⑦	⑧	⑨	⑩	⑪				⑫
A200200510353	SP 0510.03	NDW 100 QU V115	5	10	3 x 50		②	③										■	20
A2002005103530001	SP 0510.03	NDW 100 QU V115	5	10	3 x 30		②	③										■	20
A200200810353	SP 0810.03	NDW 100 QU V115	8	10	3 x 50		②	③										■	20
A2002008103530001	SP 0810.03	NDW 100 QU V115	8	10	3 x 30		②	③										■	20

Shape SP, Pointed nose (according to DIN 69170)



Grinding, Polishing
(bonded)

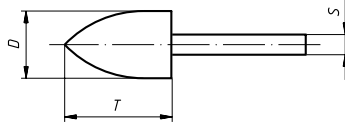

Ordering example: A200200306302

Further dimensions, qualities and shank lengths on request.

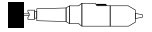

PG 3

Product number	Description	Quality	D mm	T mm	S mm	recommended for Information on page 438		
A200200306302	SP 0306.03	EKR 100 N V4	3	6	3 x 30	① ② ③	■	20
A200200306347	SP 0306.03	RKD 120 QU V21	3	6	3 x 30	② ③ ④	■	20
A200200510302	SP 0510.03	EKR 80 N V4	5	10	3 x 30	① ② ③	■	20
A200200510347	SP 0510.03	RKD 100 QU V21	5	10	3 x 30	② ③ ④	■	20
A200200510602	SP 0510.06	EKR 80 N V4	5	10	6 x 40	① ② ③	■	20
A200200816302	SP 0816.03	EKR 60 N V4	8	16	3 x 30	① ② ③	■	20
A200200816347	SP 0816.03	RKD 80 QU V21	8	16	3 x 30	② ③ ④	■	20
A200200816602	SP 0816.06	EKR 60 N V4	8	16	6 x 40	① ② ③	■	20
A200201020602	SP 1020.06	EKR 60 N V4	10	20	6 x 40	① ② ③	■	20
A200201320602	SP 1320.06	EKR 46 N V4	13	20	6 x 40	① ② ③	■	20
A200202032602	SP 2032.06	EKR 36 N V4	20	32	6 x 40	① ② ③	■	20

Shape WR, Cylindrical round nose (according to DIN 69170)

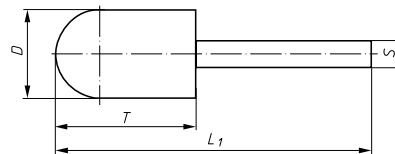

Ordering example: A201401013353

Further dimensions, qualities and shank lengths on request.



PG 3

Product number	Description	Quality	D mm	T mm	S mm	recommended for Information on page 438		
A2014010133530001	WR 1013.03	NDW 100 QU V115	10	13	3 x 30	② ③	■	20
A201401013353	WR 1013.03	NDW 100 QU V115	10	13	3 x 50	② ③	■	20

Shape KU, Spherical (according to DIN 69170)



★★★

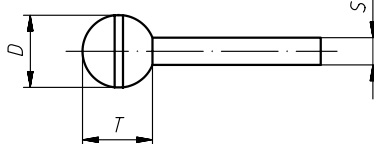

Ordering example: A201100404377

Further dimensions, qualities and shank lengths on request.



Grinding. Polishing (bonded)



PG 3

Product number	Description	Quality	D mm	T mm	S mm	recommended for							PG 3		
						Information on page 438									
A201100404377	KU 0404.03	CERAMIC 80 L V118	4	4	3 x 30	②	③	④				⑦		■	20
A201100606377	KU 0606.03	CERAMIC 80 L V118	6	6	3 x 30	②	③	④				⑦		■	20
A201101010677	KU 1010.06	CERAMIC 46 L V118	10	10	6 x 40	②	③	④				⑦		■	20
A201101313677	KU 1313.06	CERAMIC 46 L V118	13	13	6 x 40	②	③	④				⑦		■	20

Shape KU, Spherical (according to DIN 69170)



★★★

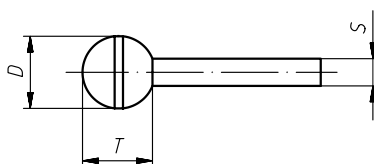

Ordering example: A201100404353

Further dimensions, qualities and shank lengths on request.



PG 3

Product number	Description	Quality	D mm	T mm	S mm	recommended for							PG 3		
						Information on page 438									
A2011004043530001	KU 0404.03	NDW 100 QU V115	4	4	3 x 30	②	③							■	20
A201100404353	KU 0404.03	NDW 100 QU V115	4	4	3 x 50	②	③							■	20
A2011006063530001	KU 0606.03	NDW 100 QU V115	6	6	3 x 30	②	③							■	20
A201100606353	KU 0606.03	NDW 100 QU V115	6	6	3 x 50	②	③							■	20
A2011008083530001	KU 0808.03	NDW 100 QU V115	8	8	3 x 30	②	③							■	20
A201100808353	KU 0808.03	NDW 100 QU V115	8	8	3 x 50	②	③							■	20

Shape KU, Spherical (according to DIN 69170)



Grinding, Polishing (bonded)

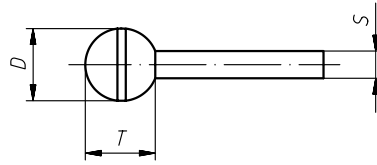

Ordering example: A201100606302

Further dimensions, qualities and shank lengths on request.



PG 3

Product number	Description	Quality	D mm	T mm	S mm	recommended for Information on page 438			
A201100606302	KU 0606.03	EKR 60 N V4	6	6	3 x 30	① ② ③	■	20	
A2011006063020001	KU 0606.03	EKR 80/100 QU V4	6	6	3 x 30	① ② ③	■	20	
A201100606312	KU 0606.03	EKWBR 60 0/P V7	6	6	3 x 30	① ②	■	20	
A201100606602	KU 0606.06	EKR 60 N V4	6	6	6 x 40	① ② ③	■	20	
A201100606612	KU 0606.06	EKWBR 60 0/P V7	6	6	6 x 40	① ②	■	20	
A201100808302	KU 0808.03	EKR 60 N V4	8	8	3 x 30	① ② ③	■	20	
A201100808312	KU 0808.03	EKWBR 60 0/P V7	8	8	3 x 30	① ②	■	20	
A201100808602	KU 0808.06	EKR 60 N V4	8	8	6 x 40	① ② ③	■	20	
A2011008086020001	KU 0808.06	EKR 60/80 QU V4	8	8	6 x 40	① ② ③	■	20	
A201101010302	KU 1010.03	EKR 60 N V4	10	10	3 x 30	① ② ③	■	20	
A201101010312	KU 1010.03	EKWBR 60 0/P V7	10	10	3 x 30	① ②	■	20	
A201101010347	KU 1010.03	RKD 80 P V21	10	10	3 x 30	② ③ ④	■	20	
A201101010602	KU 1010.06	EKR 60 N V4	10	10	6 x 40	① ② ③	■	20	
A201101313302	KU 1313.03	EKR 46 N V4	13	13	3 x 30	① ② ③	■	20	
A201101313602	KU 1313.06	EKR 46 N V4	13	13	6 x 40	① ② ③	■	20	
A2011013136020001	KU 1313.06	EKR 46 QU V4	13	13	6 x 40	① ② ③	■	20	
A201101616602	KU 1616.06	EKR 46 N V4	16	16	6 x 40	① ② ③	■	20	
A201101616647	KU 1616.06	RKD 60 P (6) V21	16	16	6 x 40	② ③ ④	■	20	
A201102020602	KU 2020.06	EKR 36 N V4	20	20	6 x 40	① ② ③	■	20	
A2011020206020001	KU 2020.06	EKR 60 P V21	20	20	6 x 40	① ② ③	■	20	
A201102020612	KU 2020.06	EKWBR. 46 0/P V7	20	20	6 x 40	① ②	■	20	
A201102525602	KU 2525.06	EKR 36 N V4	25	25	6 x 40	① ② ③	■	20	
A201102525627	KU 2525.06	NK 24 N BA soft	25	25	6 x 40	② ③ ④ ⑥	■	20	
A201102525647	KU 2525.06	RKD 30 QU V21	25	25	6 x 40	② ③ ④	■	20	
A201902525626	KU 2525.06	HOK 0-3 V9	25	25	6 x 40		⑧	■	20
A201103232602	KU 3232.06	EKR 30 N V4	32	32	6 x 40	① ② ③	■	20	
A201903838626	KU 3838.06	HOK 0-3 V9	38	38	6 x 40		⑧	■	20

Shape TO, Cup (according to DIN 69170)

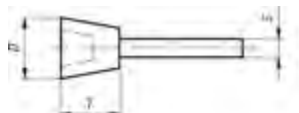

Ordering example: A202002019602

Further dimensions, qualities and shank lengths on request.



PG 3

Product number	Description	Quality	D mm	T mm	S mm	recommended for Information on page 438		
A202002019602	TO 2020.06	EKR 60 N V4	20	20	6 x 40	① ② ③	■	20
A202002524602	TO 2524.06	EKR 60 N V4	25	24	6 x 40	① ② ③	■	20
A202003229602	TO 3229.06	EKR 60 N V4	32	29	6 x 40	① ② ③	■	20
A202004036602	TO 4036.06	EKR 60 N V4	40	36	6 x 40	① ② ③	■	20

Shape KE, Conical round nose (according to DIN 69170)

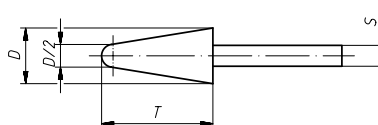

Ordering example: A201501632677



PG 3

Product number	Description	Quality	D mm	T mm	S mm	recommended for Information on page 438		
A201501632677	KE 1632.06	CERAMIC 46 L V118	16	32	6 x 40	② ③ ④ ⑦	■	20

Shape KE, Conical round nose (according to DIN 69170)



Ordering example: A201501632618A

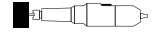

Grinding, Polishing (bonded)

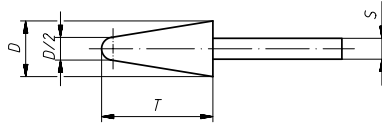

PG 3

Product number	Description	Quality	D mm	T mm	S mm	recommended for Information on page 438		
A201501632618A	KE 1632.06	SIC-ALU 80 V27 W	16	32	6 x 40	6	■	20
A201502040618A	KE 2040.06	SIC-ALU 80 V27 W	20	40	6 x 40	6	■	20

Shape KE, Conical round nose (according to DIN 69170)



Ordering example: A201501025647

Further dimensions, qualities and shank lengths on request.

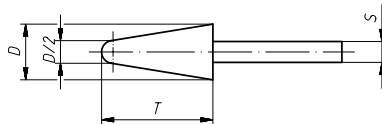
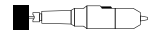

PG 3

Product number	Description	Quality	D mm	T mm	S mm	recommended for Information on page 438		
A201501025647	KE 1025.06	RKD 60 P (6) V21	10	25	6 x 40	② ③ ④	■	20
A201601025606	KE 1025.06	EKRBR 46/60 P V7	10	25	6 x 40	①	■	20
A201501632602	KE 1632.06	EKR 46 N V4	16	32	6 x 40	① ② ③	■	20
A201501632616	KE 1632.06	MK 36 N V10	16	32	6 x 40	② ④ ⑤	■	20
A201501640602	KE 1640.06	EKR 46 N V4	16	40	6 x 40	① ② ③	■	20
A2015016456470002	KE 1645.06	RKD 46 O V13	16	45	6 x 40	② ③ ④	■	20
A201601645606	KE 1645.06	EKRBR 46/60 P V7	16	45	6 x 40	①	■	20
A201502032602	KE 2032.06	EKR 36 N V4	20	32	6 x 40	① ② ③	■	20
A201502032616	KE 2032.06	MK 36 N V10	20	32	6 x 40	② ④ ⑤	■	20
A201502040602	KE 2040.06	EKR 36 N V4	20	40	6 x 40	① ② ③	■	20
A201502040616	KE 2040.06	MK 36 N V10	20	40	6 x 40	② ④ ⑤	■	20
A201502040647	KE 2040.06	RKD 36 O (6) V21	20	40	6 x 40	② ③ ④	■	20
A201502570602	KE 2570.06	EKR 36 N V4	25	70	6 x 40	① ② ③	■	20
A201503250647	KE 3250.06	RKD 30 O (6) V21	32	50	6 x 40	② ③ ④	■	20
A201503250833	KE 3250.08	HK 30 N V13	32	50	8 x 40	④ ⑤	■	20

Shape A, American shapes

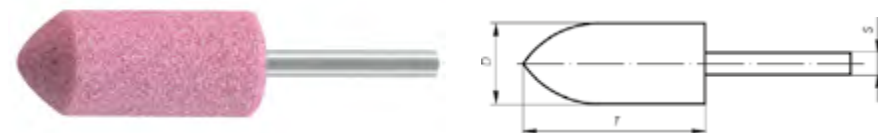

Ordering example: A206200620602

Further dimensions, qualities and shank lengths on request.



PG 3

Product number	Description	Shape	Quality	D inch	T inch	D mm	T mm	S mm	recommended for		
Information on page 438											
A2062022636020001	A1 2263.06		EKR 36 N V4	7/8	2 1/2	22	63	6 x 40	① ② ③		■ 20
A206202263633	A1 2263.06		HK 36/46 M V13	7/8	2 1/2	22	63	6 x 40		④ ⑤	■ 20
A206202532602	A2 2532.06		EKR 36 QU V4	1	1 1/4	25	32	6 x 40	① ② ③		■ 20
A206201645633	AS-3 1645.06		HK 36/46 M V13	5/8	1 3/4	16	45	6 x 40		④ ⑤	■ 20
A2062025706020001	A3 2570.06		EKR 36 N V4	1	2 3/4	25	70	6 x 40	① ② ③		■ 20
A206202570633	A3 2570.06		HK 36/46 M V13	1	2 3/4	25	70	6 x 40		④ ⑤	■ 20
A206402570833	A3 2570.08		HK 36/46 M V13	1	2 3/4	25	70	8 x 40		④ ⑤	■ 20
A206203232602	A4 3232.06		EKR 30/36 QU (7) V21	1 1/4	1 1/4	32	32	6 x 40	① ② ③		■ 20
A206202250602	A11 2250.06		EKR 36 QU V4	7/8	2	22	50	6 x 40	① ② ③		■ 20
A2062022506020001	A11 2250.06		EKR 36 N V4	7/8	2	22	50	6 x 40	① ② ③		■ 20
A206202250633	A11 2250.06		HK 36/46 M V13	7/8	2	22	50	6 x 40		④ ⑤	■ 20
A206202250626	A11 2250.06		HOK 0-3 V9	7/8	2	22	50	6 x 40		⑧	■ 20
A206402250833	A11 2250.08		HK 36/46 M V13	7/8	2	22	50	8 x 40		④ ⑤	■ 20
A206201832602	A12 1832.06		EKR 30/36 QU (7) V21	1	1 1/4	18	32	6 x 40	① ② ③		■ 20
A206200625602	A15 0625.06		EKR 80/100 QU V4	1/4	1	6	25	6 x 40	① ② ③		■ 20
A206200625633	A15 0625.06		HK 46/60 N V13	1/4	1	6	25	6 x 40		④ ⑤	■ 20
A206200620602	A24 0620.06		EKR 60/80 QU V4	1/4	3/4	6	20	6 x 40	① ② ③		■ 20
A206204010602	A36 4010.06		EKR 60/80 QU V4	1 5/8	3/8	40	10	6 x 40	① ② ③		■ 20
A206204010608	A36 4010.06		EKW 60 L (2) V13	1 5/8	3/8	40	10	6 x 40		③ ⑦ ⑨	■ 20
A206203206602	A37 3206.06		EKR 46 QU V4	1 1/4	1/4	32	6	6 x 40	① ② ③		■ 20

Shape B, American shapes



Grinding, Polishing
(bonded)

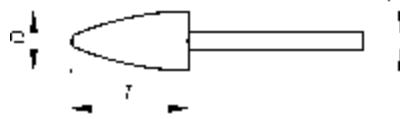

Ordering example: A206600816302

Further dimensions, qualities and shank lengths on request.

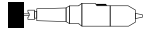

PG 3

Product number	Description	Shape	Quality	D inch	T inch	D mm	T mm	S mm	recommended for Information on page 438		
A206601616302	B41 1616.03		EKR 60/80 QU V4	5/8	5/8	16	16	3 x 30	① ② ③	■	20
A206601020302	B52 1020.03		EKR 46 QU V4	3/8	3/4	10	20	3 x 30	① ② ③	■	20
A206600816302	B53 0816.03		EKR 60/80 QU V4	5/16	5/8	8	16	3 x 30	① ② ③	■	20

Miniature mounted points

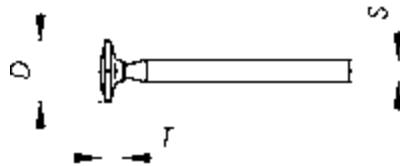

Ordering example: A202900001302

Further dimensions, qualities and shank lengths on request.

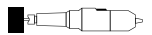

PG 3

Product number	Description	Shape	Quality	D mm	T mm	S mm	recommended for Information on page 438		
A202900001302	D1		EKR 100 N V4	9	2	3 x 30	① ② ③	■	20
A202900001311	D1		EKBR 100 M V1/6	9	2	3 x 30	② ③	■	20
A202900002302	D2		EKR 80 N V4	9	3	3 x 30	① ② ③	■	20
A202900002311	D2		EKBR 80 M V1/6	9	3	3 x 30	② ③	■	20
A202900003302	D3		EKR 100 N V4	8	2	3 x 30	① ② ③	■	20
A202900003311	D3		EKBR 100 M V1/6	8	2	3 x 30	② ③	■	20
A202900004302	D4		EKR 100 N V4	4	1	3 x 30	① ② ③	■	20
A202900004311	D4		EKBR 100 M V1/6	4	1	3 x 30	② ③	■	20
A202900005302	D5		EKR 80 N V4	5	3	3 x 30	① ② ③	■	20
A202900005311	D5		EKBR 80 M V1/6	5	3	3 x 30	② ③	■	20
A202900006302	D6		EKR 80 N V4	7/4	6	3 x 30	① ② ③	■	20

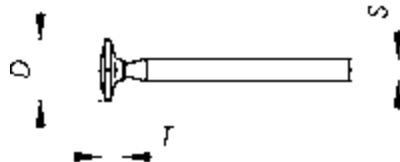
Miniature mounted points

Ordering example: A202900001302

Further dimensions, qualities and shank lengths on request.



Grinding. Polishing (bonded)



PG 3

Product number	Description	Shape	Quality	D mm	T mm	S mm	recommended for	Information on page 438		
A202900007302	D7		EKR 100 NV4	2,5/5	2,5	3 x 30	① ② ③		■	20
A202900007311	D7		EKBR 100 MV1/6	2,5/5	2,5	3 x 30	② ③		■	20
A202900008302	D8		EKR 100 NV4	2,5/6	3	3 x 30	① ② ③		■	20
A202900008311	D8		EKBR 100 MV1/6	2,5/6	3	3 x 30	② ③		■	20
A202900009302	D9		EKR 80 NV4	3,5/8	4	3 x 30	① ② ③		■	20
A202900009311	D9		EKBR 80 MV1/6	3,5/8	4	3 x 30	② ③		■	20
A202900010302	D10		EKR 100 NV4	2/3,2	4	3 x 30	① ② ③		■	20
A202900010311	D10		EKBR 100 MV1/6	2/3,2	4	3 x 30	② ③		■	20
A202900011302	D11		EKR 80 NV4	5	5	3 x 30	① ② ③		■	20
A202900012302	D12		EKR 80 NV4	4/7	6	3 x 30	① ② ③		■	20
A202900012311	D12		EKBR 80 MV1/6	4/7	6	3 x 30	② ③		■	20
A202900013302	D13		EKR 100 NV4	3	3	3 x 30	① ② ③		■	20
A202900013311	D13		EKBR 100 MV1/6	3	3	3 x 30	② ③		■	20
A202900014302	D14		EKR 80 NV4	4	4	3 x 30	① ② ③		■	20
A202900014311	D14		EKBR 80 MV1/6	4	4	3 x 30	② ③		■	20
A202900015302	D15		EKR 80 NV4	5	5	3 x 30	① ② ③		■	20
A202900015311	D15		EKBR 80 MV1/6	5	5	3 x 30	② ③		■	20
A202900016302	D16		EKR 100 NV4	3	4	3 x 30	① ② ③		■	20
A202900016311	D16		EKBR 100 MV1/6	3	4	3 x 30	② ③		■	20
A202900017302	D17		EKR 80 NV4	4	5	3 x 30	① ② ③		■	20
A202900017311	D17		EKBR 80 MV1/6	4	5	3 x 30	② ③		■	20
A202900018302	D18		EKR 80 NV4	7	8	3 x 30	① ② ③		■	20
A202900018311	D18		EKBR 80 MV1/6	7	8	3 x 30	② ③		■	20
A202900020302	D20		EKR 100 NV4	7	5	3 x 30	① ② ③		■	20
A202900021302	D21		EKR 100 NV4	8	1,6	3 x 30	① ② ③		■	20
A202900021311	D21		EKBR 100 MV1/6	8	1,6	3 x 30	② ③		■	20
A202900022302	D22		EKR 100 NV4	2,5	6	3 x 30	① ② ③		■	20
A202900022311	D22		EKBR 100 MV1/6	2,5	6	3 x 30	② ③		■	20
A202900023302	D23		EKR 80 NV4	5	6	3 x 30	① ② ③		■	20
A202900023311	D23		EKBR 80 MV1/6	5	6	3 x 30	② ③		■	20
A202900024302	D24		EKR 60 NV4	6	6	3 x 30	① ② ③		■	20
A202900024311	D24		EKBR 60 MV1/6	6	6	3 x 30	② ③		■	20
A202900025302	D25		EKR 100 NV4	5	1,5	3 x 30	① ② ③		■	20

Miniature mounted points

★★☆

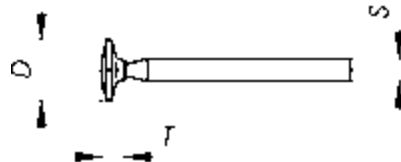
Grinding, Polishing (bonded)



Ordering example: A202900001302

Further dimensions, qualities and shank lengths on request.

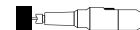

PG 3

Product number	Description	Shape	Quality	D mm	T mm	S mm	recommended for Information on page 438			
A202900026302	D26		EKR 100 NV4	6	2,5	3 x 30	① ② ③			■ 20
A202900026311	D26		EKBR 100 M V1/6	6	2,5	3 x 30	② ③			■ 20
A202900027302	D27		EKR 100 NV4	2/3,5	10	3 x 30	① ② ③			■ 20
A202900028302	D28		EKR 80 NV4	3,5/5,5	11	3 x 30	① ② ③			■ 20
A202900029302	D29		EKR 100 NV4	3	6,4	3 x 30	① ② ③			■ 20
A202900029311	D29		EKBR 100 M V1/6	3	6,4	3 x 30	② ③			■ 20
A202900030302	D30		EKR 100 NV4	4,4	10	3 x 30	① ② ③			■ 20
A202900030311	D30		EKBR 100 M V1/6	4,4	10	3 x 30	② ③			■ 20
A202900032302	D32		EKR 100 NV4	5	7	3 x 30	① ② ③			■ 20
A202900032311	D32		EKBR 100 M V1/6	5	7	3 x 30	② ③			■ 20
A202900033302	D33		EKR 80 NV4	6	8	3 x 30	① ② ③			■ 20
A202900033311	D33		EKBR 80 M V1/6	6	8	3 x 30	② ③			■ 20
A202900034302	D34		EKR 100 NV4	4,37	7	3 x 30	① ② ③			■ 20
A202900034311	D34		EKBR 100 M V1/6	4,37	7	3 x 30	② ③			■ 20
A202900035302	D35		EKR 80 NV4	6	10	3 x 30	① ② ③			■ 20
A202900035311	D35		EKBR 80 M V1/6	6	10	3 x 30	② ③			■ 20
A202900036302	D36		EKR 80 NV4	6	11	3 x 30	① ② ③			■ 20
A202900036311	D36		EKBR 80 M V1/6	6	11	3 x 30	② ③			■ 20

Taper sided, grinding wheels, Shape SE4 (nach ISO 603-12)



Ordering example: A2039080200320001

max. operating speed
50 m/s = 11.900 1/min

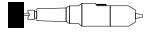

PG 3

Product number	Description	Quality	D mm	T mm	U mm	H mm	J mm	recommended for Information on page 438		
A2039080200320001	SE4 08020.16	HK 24 M BA soft	80	20	16	16	25	④ ⑤	■	10
A2039080200320002	SE4 08020.16	HK 16 P BA hart	80	20	16	16	25	④ ⑤	■	10
A2039080200320003	SE4 08020.20	HK 24 M BA soft	80	20	16	20	25	④ ⑤	■	10
A2039080200320004	SE4 08020.20	HK 16 P BA hart	80	20	16	20	25	④ ⑤	■	10

These tools must be used with a flange which complies with the regulations of DIN 69864.

Grinding, Polishing
(bonded)

Handstones



Grinding, Polishing
(bonded)

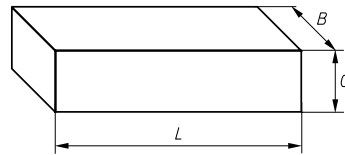

Ordering example: A20430000118

Further dimensions (see table below) and qualities on request.



PG 3

Product number	Description	Quality	L mm	B mm	C mm	recommended for Information on page 438			
A20430000118	RU 1	SICGR 60 O V23/green=fine	50	25	15				9 ■ 5
A20430000122	RU 1	SICDKL 24 O V23/dark=coarse	50	25	15				9 ■ 5
A20430000218	RU 2	SICGR 60 O V23/green=fine	100	30	15				9 ■ 5
A20430000222	RU 2	SICDKL 24 O V23/dark=coarse	100	30	15				9 ■ 5
A20430000318	RU 3	SICGR 60 O V23/green=fine	100	50	25				9 ■ 5
A20430000322	RU 3	SICDKL 24 O V23/dark=coarse	100	50	25				9 ■ 5
A20430000418	RU 4	SICGR 60 O V23/green=fine	150	50	25				9 ■ 5
A20430000422	RU 4	SICDKL 24 O V23/dark=coarse	150	50	25				9 ■ 5
A2043150251608	RU 5	EKW 100 E (9) V40	150	25	16,5		3		■ 5
A2043200502508	RU 6	EKW 100 E (9) V40	200	50	25		3		■ 5

RU 1-4 is particularly suitable for

- profiling
- opening of pores
- sharpening
- dressing

of bonded grinding and polishing tools.

Available dimensions for handstones

Shape	length mm	width mm	height mm
	25	15	5-30
	44	35	18-30
	48	19	5-30
	50	25	10-35
	90	70	20-35
	100	30	10-35
	100	50	10-35
	120	10	5-35
	150	25	10-35
	150	50	10-35
	200	50	10-35
half-round	216	78	20-35
	150	13	5-35

Mounted point-Assortment



Ordering example: A20480005677F1



PG 3

Product number	Description	Shank diameter mm	Quality	Contents	1 piece each	recommended for	Information on page 438		
A20480005677F1	Assortment Ceramic	6	Ceramic	5-pieces	ZY 1020, ZY 1632, SP 1320, KU 1313. KE 1632	② ③ ④ ⑦		■	1

Mounted point assortment INOX



Ordering example: A20480004627WF1



PG 3

Product number	Description	Shank diameter mm	Quality	Contents	1 piece each	recommended for	Information on page 438		
A20480004627WF1	Assortment Inox	6	NK BA	4-pieces	ZY 1332.06 NK 24 N BA Soft, ZY 2040.06 NK 24 N BA Soft, ZY2 4006.06 NK 24 N BA Soft, KU 2525.06 NKB/NK 24 R BA 98	② ③ ④ ⑥		■	1

Mounted point assortment Steel



Ordering example: A20480005602F1



PG 3

Product number	Description	Shank diameter mm	Quality	Contents	1 piece each	recommended for	Information on page 438		
A20480005602F1	Assortment Steel	6	EKR	5-pieces	ZY 1632.06 EKR 46 N V4, ZY 2525.06 EKR 36 N V4, WKS 2025.06 EKR 60 N V4, KU 2525.06, EKR 36 N V4, KE 1632.06, EKR 46 N V4	① ② ③		■	1

Mounted point-Assortment

★★★

Grinding, Polishing (bonded)



Ordering example: A20100000353

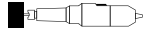

PG 3

Product number	Description	Shank diameter mm	Quality	Contents	1 piece each	recommended for Information on page 438		
A20100000353	Assortment 10	3 x 50	NDW	10-pieces	ZY 0408, ZY 0610, ZY 0810, ZY 1013, SP 0510, SP 0810, KU 0404, KU 0606, KU 0808, WR 1013	② ③	■	1

Mounted point-Assortment (according to DIN 69170)

★★☆



Ordering example: A20460000202



PG 3

Product number	Description	Image	Shank diameter mm	Quality	Contents	1 piece each	recommended for Information on page 438		
A204700001402	Assortment 14		3 x 30	EKR	14-pieces	ZY 0205, ZY 0306, ZY 0408, ZY 0510, ZY 0610, ZY 0810, ZY 0816, ZY 1010, ZY 1013, ZY 1313, KU 0808, ZY2 1303, ZY2 1604, ZY2 2006	① ② ③	■	1
A20460000202	Assortment 45		6 x 40	EKR	45-pieces	ZY 0306, ZY 0510, ZY 0408, ZY 0610, ZY 0810, ZY 0816, ZY 1010, ZY 1020, ZY 1032, ZY2 1303, ZY 1313, ZY 1320, ZY2 1604, ZY 1616, ZY 1620, ZY 1632, ZY2 2006, ZY 2020, ZY 2025, ZY 2032, ZY 2040, ZY2 2506, ZY2 2510, ZY 2520, ZY 2525, ZY 2532, ZY2 3208, ZY 3220, ZY 3232, ZY2 4010, ZY 4020, SP 0816, SP 1020, SP 1320, SP 2032, KE 1632, KE 1640, KE 2032, KE 2040, KU 1010, KU 1313, KU 1616, KU 2020, KU 2525, KU 3232	① ② ③	■	1

Mounted point-Assortment (according to DIN 69170)

★★☆

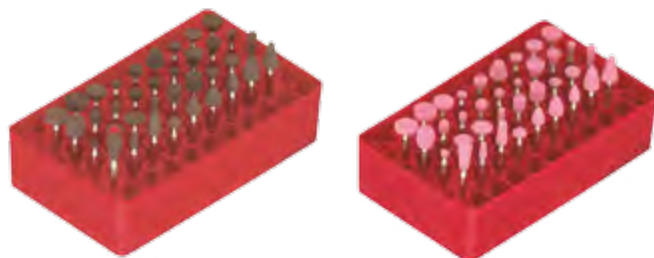

Ordering example: A204800003611



Grinding. Polishing (bonded)



PG 3

Product number	Description	Image	Shank diameter mm	Quality	Contents	1 piece each	recommended for Information on page 438		
A204800003611	Assortment 36		3 x 30	EKbr	36-pieces	D1, D2, D3, D4, D5, D6, D7, D8, D9, D10, D11, D12, D13, D14, D15, D16, D17, D18, D19, D20, D21, D22, D23, D24, D25, D26, D27, D28, D29, D30, D31, D32, D33, D34, D35, D36	② ③	■	1
A204800003602	Assortment 36		3 x 30	EKR	36-pieces	D1, D2, D3, D4, D5, D6, D7, D8, D9, D10, D11, D12, D13, D14, D15, D16, D17, D18, D19, D20, D21, D22, D23, D24, D25, D26, D27, D28, D29, D30, D31, D32, D33, D34, D35, D36	① ② ③	■	1

Grinding wheels – especially for your particular application

We are pleased to be able to offer you a “tailor-made” grinding wheel quality e.g.:

- Wheels in special qualities
- Wheels with special dimensions
- Wheels with special profiles
- Mounted points with imperial dimensions and/or imperial shanks
- Mounted points with internal threads and threaded shanks to suit
- Cup wheels
- Grinding wheels – plain and tapered
- Mounted points with extended shanks
- Mounted points with threaded shanks and extended shanks to suit
- Handstones and dressing sticks
- and many more

Please advise us of your application problem with all relevant information – the quicker this is done, the quicker we can react! The relevant information required is:

- Shape, dimensions, shank, bore size of the abrasive wheel (a sketch or technical drawing would be of great assistance)
- Material to be ground
- Type of application (e.g. fettling, deburring)
- Surface finish requirements
- Machine R.P.M
- anticipated order quantity
- wheel currently being used (type, quality...)
- etc.



Polishing tools

130 General Information	155 Marbling points and polishing points, group P6
131 Areas of application	157 Polishing roll, group P6
132 A summary of available shapes	158 Polishing disc, group P6
133 Polishing points, group P1	161 Small polishing points, group P7
136 Polishing points, group P2	
140 Felt polishing points, group P3	
144 Abrasive and diamond pastes	
146 Polishing sticks, group P4	
148 Polishing points, group P5	
151 Polishing wheels, group P6	
154 Mounting system for polishing wheels	

Product line marking

The product lines are illustrated by star symbols at the top of the table; please refer to page **14** and **15**.

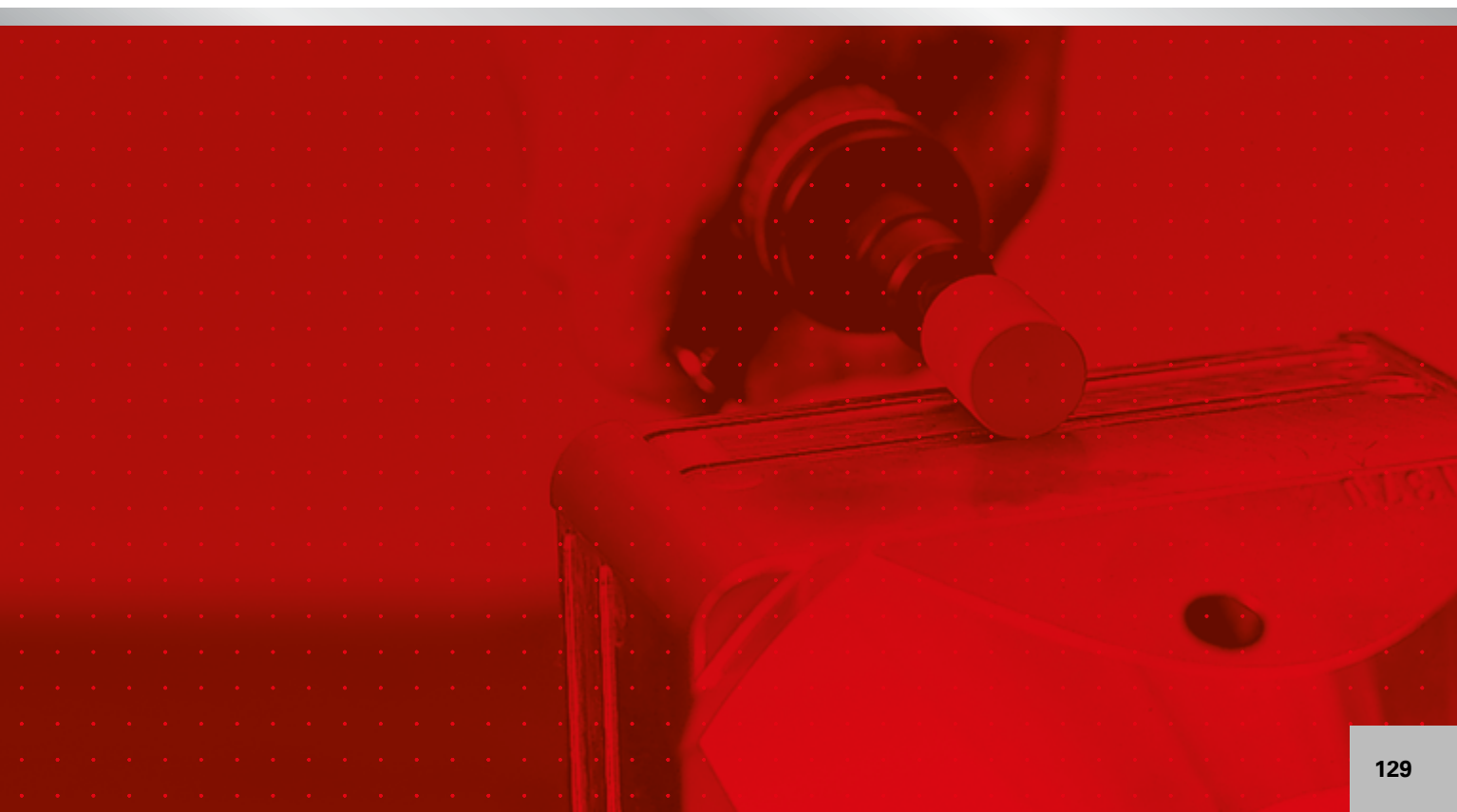
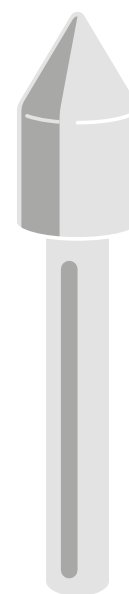

General Information

Should you wish to enhance your product with the desired optical polish or where a defined technical surface finish value must be achieved, there are many good reasons why LUKAS polishing tools can be used on your particular workpiece. Current examples of applications where the highest precision and tolerances must be achieved can be found in the car industry, pump and turbine manufacture and the aerospace industry. Polished surfaces guarantee hygienic and clean working conditions in the food and pharmaceutical industries. The tool and mould manufacturers polish surfaces to a mirror finish in order to achieve a precise replication of the profile to the finished product.

LUKAS polishing tools are divided into groups – P1 to P7 – to suit specific applications. These tools include polishing wheels, points and sticks to cover a wide variety of applications. On the following page, you will find an illustration giving a general overview of such applications.

Safety instructions

LUKAS polishing points under groups P1 and P5 are manufactured according to EN 12413 and are allowed to run at max. 50m/s. However, group P2 is only allowed max. 16m/s. The permissible peripheral speed of the product group P6 depends upon the hardness grade which in the case of MWP is max. 20m/s. The optimal working speed however generally lies below the maximum allowed; this reduces the heat generated and increases tool life. LUKAS polishing mounted points are supplied with a safety ticket which stipulates maximum R.P.M. for different shaft overhang lengths.

For the safe use of polishing points and wheels, please take note of the following operating instructions:

- FEPA safety recommendations for the correct use of abrasive products
- FEPA safety instructions for bonded abrasives

Areas of application

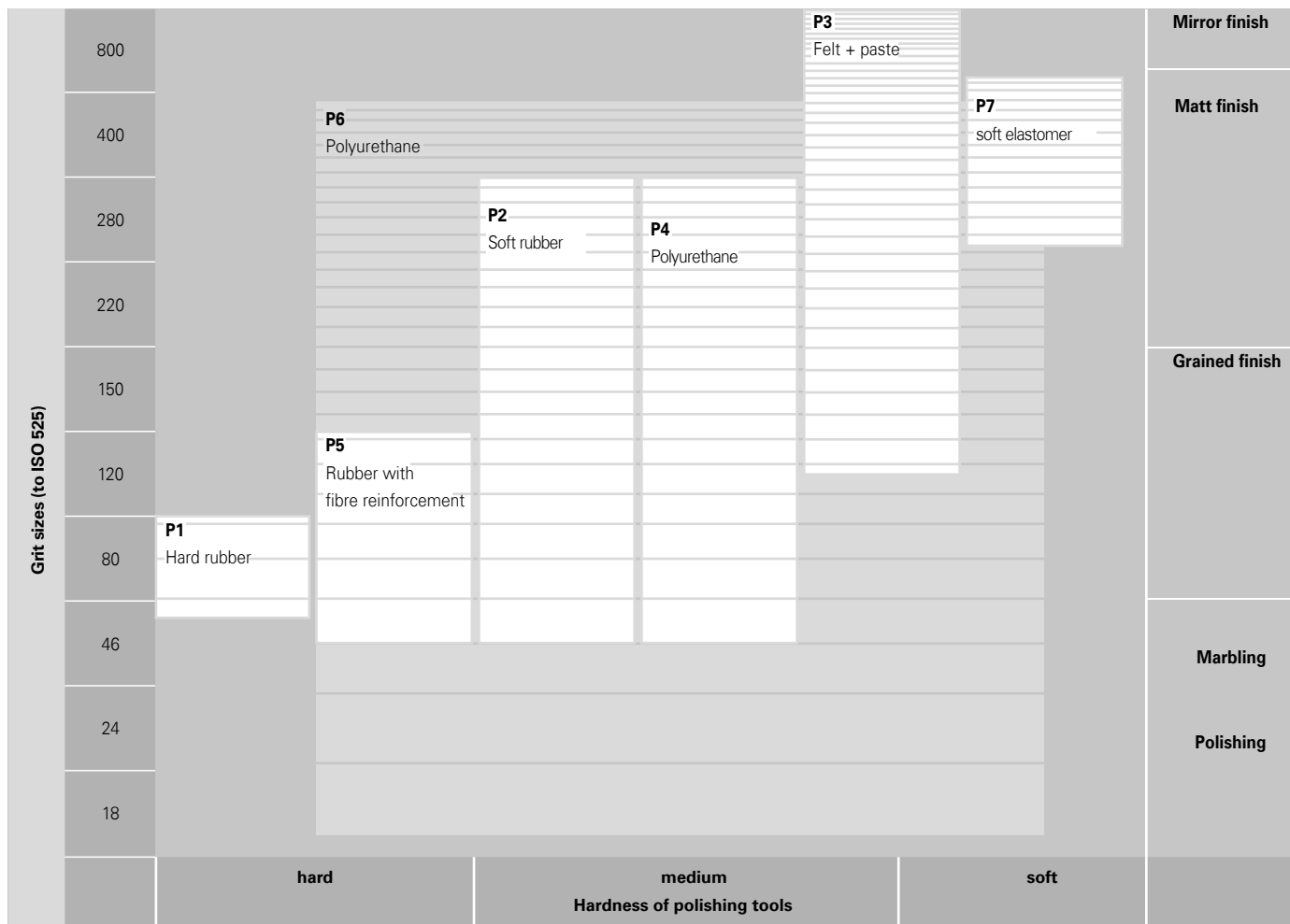

Grinding, Polishing (bonded)

P1	Polishing points consist of a hard rubber bonding with a grit size 100. They are suited for fine finishing applications and for the preparation of surfaces which require further polishing operations
P2	Polishing points and wheels are manufactured using a soft rubber bond in grit sizes 46 to 280. Grained and matt finishes on small surface areas can be produced; to achieve the required result, different grit sizes used in sequence should be applied.
P3	Felt polishing tools are used in conjunction with a SIC or diamond polishing paste to give the best results even up to a mirror finish.
P4	Polishing sticks are manufactured from polyurethane (PU). Areas of application and the results are similar to those detailed in group P2. Polishing sticks are used manually.
P5	Polishing points contain a fibre reinforcement to increase tool life. The surface finish achieved lies between group P1 and P2.
P6	Polishing tools are available in various forms – mounted points, marbling points, rolls for satin finishes, polishing wheels and polishing discs. The hardness of the polyurethane bonding (PU) can be divided into 4 categories – from soft to hard. Available grit sizes in SIC 24 to 400. These tools give the opportunity of a much wider field of application including larger surfaces. The main application is on stationary polishing machines e.g. centerless polishing of tubes.P
P7	Polishing mounted points with shaft diameter 2,35 mm using SIC grain in sizes 240 or 400 in a silicon bond. These small tools are very soft and are exceptionally suited for the polishing of jewellery and other small parts.

A summary of available shapes

Grinding, Polishing
(bonded)

shape	Type	Shape (Lukas)	Available product range
	Cylindrical, type 1	ZY	P1, P2, P3, P5, P6
	Cylindrical, type 2	ZY2	P1, P2
	Spherical	KE	P1, P2, P3
	Conical	KU	P2, P2, P3, P5
	Arch pointed nose	SP	P2, P3, P5
	Cylindrical round nose	WR	P1, P2
	Wheel	SE1	P3, P6
	Roll	PW	P6
	Stick	SF, SR, SV	P4
	Disc	R	P7
	Lense	L	P7
	Disc	PT	P6

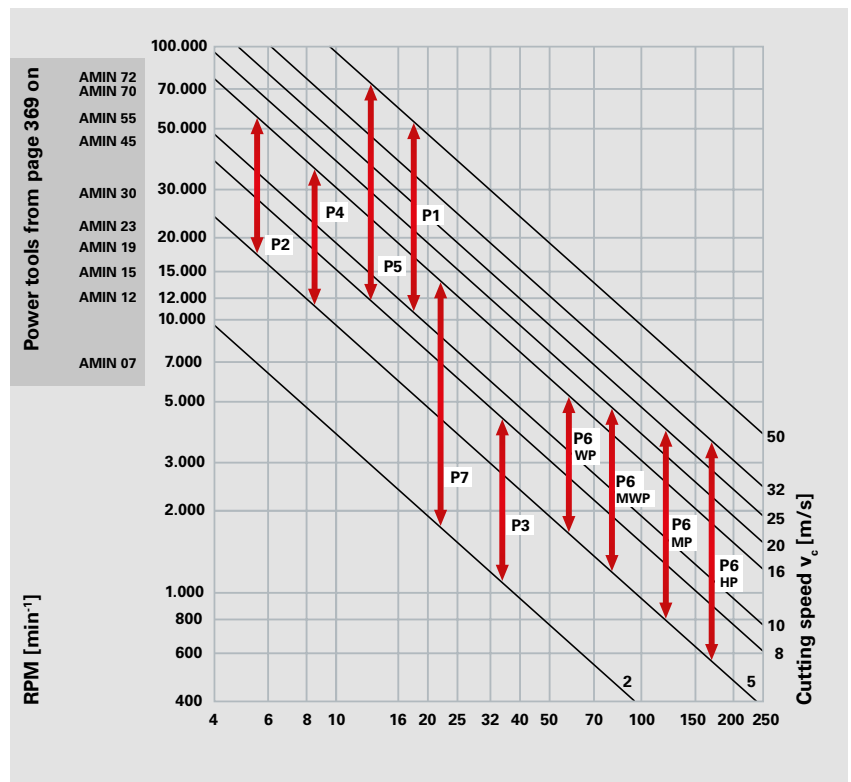

Quality and application P1

These polishing points are available in one grit combination only. The surface finish is similar to a finish with grit size 100. The hard-rubber bond makes these points particularly suitable for finishing

castings, hard and soft tool steels and also alloyed steel. There is no loading with these points. If applied with low pressure, they have a long and economical tool life.

Shape ZY, Cylindrical (according to DIN 69170)

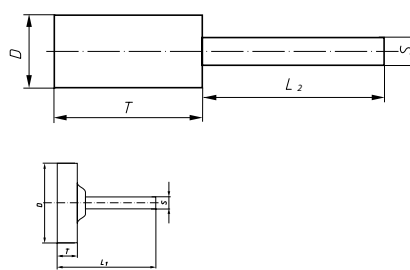

Ordering example: A2600004083

Further dimensions on request

v_{max.}: 50 m/s

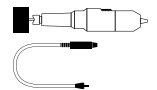

PG 3

Product number	Description	Type	D mm	T mm	S mm	L ₂ mm	recommended for	Information on page 438		
A2600004083	P1ZY 0408.03	1	4	8	3	30	1 2 3 4 5 7		■	20
A2600005103	P1ZY 0510.03	1	5	10	3	30	1 2 3 4 5 7		■	20
A2600006103	P1ZY 0610.03	1	6	10	3	30	1 2 3 4 5 7		■	20
A2600007103	P1ZY 0710.03	1	7	10	3	30	1 2 3 4 5 7		■	20
A2600008103	P1ZY 0810.03	1	8	10	3	30	1 2 3 4 5 7		■	20
A2600008166	P1ZY 0816.06	1	8	16	6	40	1 2 3 4 5 7		■	10
A2600008206	P1ZY 0820.06	1	8	20	6	40	1 2 3 4 5 7		■	10
A2600010103	P1ZY 1010.03	1	10	10	3	30	1 2 3 4 5 7		■	20
A2600010133	P1ZY 1013.03	1	10	13	3	30	1 2 3 4 5 7		■	20
A2600010163	P1ZY 1016.03	1	10	16	3	30	1 2 3 4 5 7		■	20
A2600010206	P1ZY 1020.06	1	10	20	6	40	1 2 3 4 5 7		■	10
A2607013033	P1ZY 1303.03	2	13	3	3	30	1 2 3 4 5 7		■	20
A2600013133	P1ZY 1313.03	1	13	13	3	30	1 2 3 4 5 7		■	20
A2600013163	P1ZY 1316.03	1	13	16	3	30	1 2 3 4 5 7		■	20
A2600013206	P1ZY 1320.06	1	13	20	6	40	1 2 3 4 5 7		■	10
A2607016043	P1ZY 1604.03	2	16	4	3	30	1 2 3 4 5 7		■	20
A2600016163	P1ZY 1616.03	1	16	16	3	30	1 2 3 4 5 7		■	20
A2600016206	P1ZY 1620.06	1	16	20	6	40	1 2 3 4 5 7		■	10
A2600016326	P1ZY 1632.06	1	16	32	6	40	1 2 3 4 5 7		■	10
A2607020063	P1ZY 2006.03	2	20	6	3	30	1 2 3 4 5 7		■	20
A2600020206	P1ZY 2020.06	1	20	20	6	40	1 2 3 4 5 7		■	10
A2600020326	P1ZY 2032.06	1	20	32	6	40	1 2 3 4 5 7		■	10
A2607032106	P1ZY 3210.06	2	32	10	6	40	1 2 3 4 5 7		■	10
A2600032166	P1ZY 3216.06	1	32	16	6	40	1 2 3 4 5 7		■	10
A2600040206	P1ZY 4020.06	1	40	20	6	40	1 2 3 4 5 7		■	10

Shape KS, conical pointed nose (according to DIN 69170)



Grinding, Polishing (bonded)

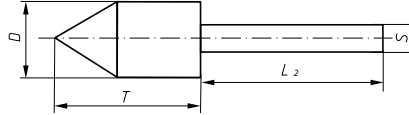

Ordering example: A2602016326

Further dimensions on request

$v_{max.}$: 50 m/s

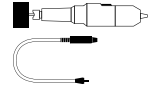

PG 3

Product number	Description	D mm	T mm	S mm	L ₂ mm	recommended for Information on page 438		
A2602016326	P1KS 1632.06	16	32	6	40	1 2 3 4 5 7	■	10

Shape KU, Spherical (according to DIN 69170)

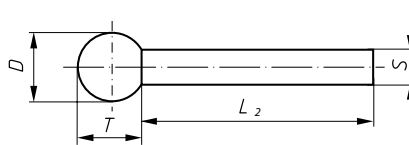

Ordering example: A2605008083

Further dimensions on request

$v_{max.}$: 50 m/s

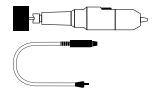

PG 3

Product number	Description	D mm	T mm	S mm	L ₂ mm	recommended for Information on page 438		
A2605008083	P1KU 0808.03	8	8	3	30	1 2 3 4 5 7	■	20
A2605016166	P1KU 1616.06	16	16	6	39	1 2 3 4 5 7	■	10

Shape WR, Cylindrical round nose (according to DIN 69170)

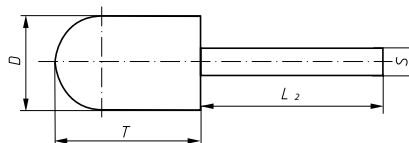

Ordering example:

$v_{max.}$: 50 m/s

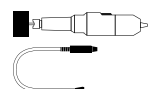

PG 3

available on request

Shape KE, Conical round nose (according to DIN 69170)

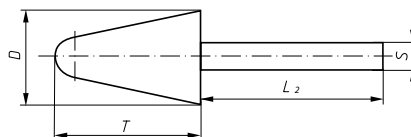

Ordering example: A2609020326

Further dimensions on request

$v_{max.}$: 50 m/s

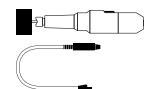

PG 3

Product number	Description	D mm	T mm	S mm	L ₂ mm	recommended for Information on page 438		
A2609020326	P1KE 2032.06	20	32	6	40	<input checked="" type="checkbox"/> 1 <input checked="" type="checkbox"/> 2 <input checked="" type="checkbox"/> 3 <input checked="" type="checkbox"/> 4 <input checked="" type="checkbox"/> 5 <input checked="" type="checkbox"/> 7	■	10

Grinding, Polishing (bonded)

Assortment, Polishing points, 114



Ordering example: A2600114

Further dimensions on request

$v_{max.}$: 50 m/s

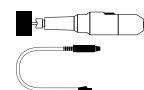

PG 3

Product number	Description	Contents	1 piece each	recommended for Information on page 438		
A2600114	Assortment 114	14-pieces	P1ZY 0408.03; P1ZY 0510.03; P1ZY 0610.03; P1ZY 0710.03; P1ZY 0810.03; P1ZY 1010.03; P1ZY 1013.03; P1ZY 1016.03; P1ZY 1303.03; P1ZY 1313.03; P1ZY 1316.03; P1ZY 1604.03; P1ZY 1616.03; P1ZY 2006.03	<input checked="" type="checkbox"/> 1 <input checked="" type="checkbox"/> 2 <input checked="" type="checkbox"/> 3 <input checked="" type="checkbox"/> 4 <input checked="" type="checkbox"/> 5 <input checked="" type="checkbox"/> 7	■	1

Specification and application P2

The polishing mounted points of this group are available in the five grit sizes as detailed below, and are available in a variety of shapes and sizes. They are colour coded to prevent any confusion and to avoid any errors in the polishing process. The soft rubber bonding allows for a very soft grinding effect. Polishing points of this group P2 are mainly used on a pre-machined surface where a

fine polished finish is required. Polishing wheels in this group are also available with a max. diameter 200mm. Exact dimensions and prices are available on request.



Colour	black	pale grey	red	brown	green
Grit	46	80	120	220	280

Shape ZY, Cylindrical (according to DIN 69170)

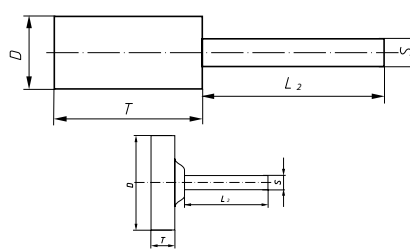

Ordering example: A2610004083080

Further dimensions and grit sizes on request

$v_{max.}$: 16 m/s

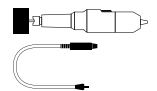

PG 3

Product number	Description	Grit	Type	D mm	T mm	S mm	L ₂ mm	recommended for		
A2610004083080	P2ZY 0408.03	80	1	4	8	3	30	① ② ③ ④ ⑤ ⑥ ⑦ ⑧	■	20
A2610004083120	P2ZY 0408.03	120	1	4	8	3	30	① ② ③ ④ ⑤ ⑥ ⑦ ⑧	■	20
A2610004083220	P2ZY 0408.03	220	1	4	8	3	30	① ② ③ ④ ⑤ ⑥ ⑦ ⑧	■	20
A2610004083280	P2ZY 0408.03	280	1	4	8	3	30	① ② ③ ④ ⑤ ⑥ ⑦ ⑧	■	20
A2610005103080	P2ZY 0510.03	80	1	5	10	3	30	① ② ③ ④ ⑤ ⑥ ⑦ ⑧	■	20
A2610005103120	P2ZY 0510.03	120	1	5	10	3	30	① ② ③ ④ ⑤ ⑥ ⑦ ⑧	■	20
A2610005103220	P2ZY 0510.03	220	1	5	10	3	30	① ② ③ ④ ⑤ ⑥ ⑦ ⑧	■	20
A2610005103280	P2ZY 0510.03	280	1	5	10	3	30	① ② ③ ④ ⑤ ⑥ ⑦ ⑧	■	20
A2610006103080	P2ZY 0610.03	80	1	6	10	3	30	① ② ③ ④ ⑤ ⑥ ⑦ ⑧	■	20
A2610006103120	P2ZY 0610.03	120	1	6	10	3	30	① ② ③ ④ ⑤ ⑥ ⑦ ⑧	■	20
A2610006103220	P2ZY 0610.03	220	1	6	10	3	30	① ② ③ ④ ⑤ ⑥ ⑦ ⑧	■	20
A2610006103280	P2ZY 0610.03	280	1	6	10	3	30	① ② ③ ④ ⑤ ⑥ ⑦ ⑧	■	20
A2610008103046	P2ZY 0810.03	46	1	8	10	3	30	① ② ③ ④ ⑤ ⑥ ⑦ ⑧	■	20

Shape ZY, Cylindrical (according to DIN 69170)

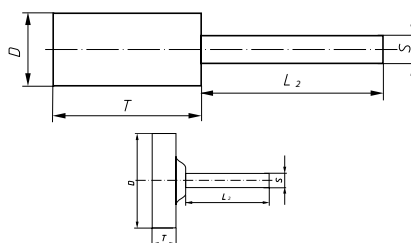

Ordering example: A2610004083080

Further dimensions and grit sizes on request

v_{max.}: 16 m/s

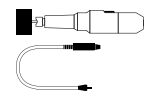

PG 3

Product number	Description	Grit	Type	D mm	T mm	S mm	L ₂ mm	recommended for Information on page 438		
A2610008103080	P2ZY 0810.03	80	1	8	10	3	30	① ② ③ ④ ⑤ ⑥ ⑦ ⑧	■	20
A2610008103120	P2ZY 0810.03	120	1	8	10	3	30	① ② ③ ④ ⑤ ⑥ ⑦ ⑧	■	20
A2610008103220	P2ZY 0810.03	220	1	8	10	3	30	① ② ③ ④ ⑤ ⑥ ⑦ ⑧	■	20
A2610008103280	P2ZY 0810.03	280	1	8	10	3	30	① ② ③ ④ ⑤ ⑥ ⑦ ⑧	■	20
A2610008166080	P2ZY 0816.06	80	1	8	16	6	30	① ② ③ ④ ⑤ ⑥ ⑦ ⑧	■	10
A2610008166120	P2ZY 0816.06	120	1	8	16	6	30	① ② ③ ④ ⑤ ⑥ ⑦ ⑧	■	10
A2610008166220	P2ZY 0816.06	220	1	8	16	6	30	① ② ③ ④ ⑤ ⑥ ⑦ ⑧	■	10
A2610008166280	P2ZY 0816.06	280	1	8	16	6	30	① ② ③ ④ ⑤ ⑥ ⑦ ⑧	■	10
A2610010103046	P2ZY 1010.03	46	1	10	10	3	30	① ② ③ ④ ⑤ ⑥ ⑦ ⑧	■	20
A2610010103080	P2ZY 1010.03	80	1	10	10	3	30	① ② ③ ④ ⑤ ⑥ ⑦ ⑧	■	20
A2610010103120	P2ZY 1010.03	120	1	10	10	3	30	① ② ③ ④ ⑤ ⑥ ⑦ ⑧	■	20
A2610010103220	P2ZY 1010.03	220	1	10	10	3	30	① ② ③ ④ ⑤ ⑥ ⑦ ⑧	■	20
A2610010103280	P2ZY 1010.03	280	1	10	10	3	30	① ② ③ ④ ⑤ ⑥ ⑦ ⑧	■	20
A2610010206080	P2ZY 1020.06	80	1	10	20	6	40	① ② ③ ④ ⑤ ⑥ ⑦ ⑧	■	10
A2610010206120	P2ZY 1020.06	120	1	10	20	6	40	① ② ③ ④ ⑤ ⑥ ⑦ ⑧	■	10
A2610010206220	P2ZY 1020.06	220	1	10	20	6	40	① ② ③ ④ ⑤ ⑥ ⑦ ⑧	■	10
A2610010206280	P2ZY 1020.06	280	1	10	20	6	40	① ② ③ ④ ⑤ ⑥ ⑦ ⑧	■	10
A2610013133080	P2ZY 1313.03	80	1	13	13	3	40	① ② ③ ④ ⑤ ⑥ ⑦ ⑧	■	20
A2610013133120	P2ZY 1313.03	120	1	13	13	3	40	① ② ③ ④ ⑤ ⑥ ⑦ ⑧	■	20
A2610013133220	P2ZY 1313.03	220	1	13	13	3	40	① ② ③ ④ ⑤ ⑥ ⑦ ⑧	■	20
A2610013133280	P2ZY 1313.03	280	1	13	13	3	40	① ② ③ ④ ⑤ ⑥ ⑦ ⑧	■	20
A2610013163120	P2ZY 1316.03	120	1	13	16	3	40	① ② ③ ④ ⑤ ⑥ ⑦ ⑧	■	20
A2610013206046	P2ZY 1320.06	46	1	13	20	6	40	① ② ③ ④ ⑤ ⑥ ⑦ ⑧	■	10
A2610013206080	P2ZY 1320.06	80	1	13	20	6	40	① ② ③ ④ ⑤ ⑥ ⑦ ⑧	■	10
A2610013206120	P2ZY 1320.06	120	1	13	20	6	40	① ② ③ ④ ⑤ ⑥ ⑦ ⑧	■	10
A2610013206220	P2ZY 1320.06	220	1	13	20	6	40	① ② ③ ④ ⑤ ⑥ ⑦ ⑧	■	10
A2610013206280	P2ZY 1320.06	280	1	13	20	6	40	① ② ③ ④ ⑤ ⑥ ⑦ ⑧	■	10
A2610016163120	P2ZY 1616.03	120	1	16	16	3	40	① ② ③ ④ ⑤ ⑥ ⑦ ⑧	■	20
A2610016206080	P2ZY 1620.06	80	1	16	20	6	40	① ② ③ ④ ⑤ ⑥ ⑦ ⑧	■	10
A2610016206120	P2ZY 1620.06	120	1	16	20	6	40	① ② ③ ④ ⑤ ⑥ ⑦ ⑧	■	10
A2610016206220	P2ZY 1620.06	220	1	16	20	6	40	① ② ③ ④ ⑤ ⑥ ⑦ ⑧	■	10
A2610016206280	P2ZY 1620.06	280	1	16	20	6	40	① ② ③ ④ ⑤ ⑥ ⑦ ⑧	■	10
A2610016326080	P2ZY 1632.06	80	1	16	32	6	40	① ② ③ ④ ⑤ ⑥ ⑦ ⑧	■	10
A2610016326120	P2ZY 1632.06	120	1	16	32	6	40	① ② ③ ④ ⑤ ⑥ ⑦ ⑧	■	10
A2610016326220	P2ZY 1632.06	220	1	16	32	6	40	① ② ③ ④ ⑤ ⑥ ⑦ ⑧	■	10
A2610020206046	P2ZY 2020.06	46	1	20	20	6	40	① ② ③ ④ ⑤ ⑥ ⑦ ⑧	■	10
A2610020206080	P2ZY 2020.06	80	1	20	20	6	40	① ② ③ ④ ⑤ ⑥ ⑦ ⑧	■	10

Shape ZY, Cylindrical (according to DIN 69170)



Grinding, Polishing (bonded)

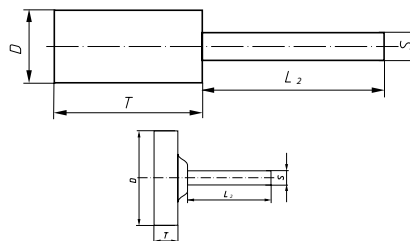

Ordering example: A2610004083080

Further dimensions and grit sizes on request

v_{max.}: 16 m/s

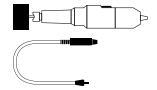

PG 3

Product number	Description	Grit	Type	D mm	T mm	S mm	L ₂ mm	recommended for Information on page 438		
A2610020206120	P2ZY 2020.06	120	1	20	20	6	40	① ② ③ ④ ⑤ ⑥ ⑦ ⑧	■	10
A2610020206220	P2ZY 2020.06	220	1	20	20	6	40	① ② ③ ④ ⑤ ⑥ ⑦ ⑧	■	10
A2610020206280	P2ZY 2020.06	280	1	20	20	6	40	① ② ③ ④ ⑤ ⑥ ⑦ ⑧	■	10
A2610020326080	P2ZY 2032.06	80	1	20	32	6	40	① ② ③ ④ ⑤ ⑥ ⑦ ⑧	■	10
A2610020326120	P2ZY 2032.06	120	1	20	32	6	40	① ② ③ ④ ⑤ ⑥ ⑦ ⑧	■	10
A2610020326220	P2ZY 2032.06	220	1	20	32	6	40	① ② ③ ④ ⑤ ⑥ ⑦ ⑧	■	10
A2610020326280	P2ZY 2032.06	280	1	20	32	6	40	① ② ③ ④ ⑤ ⑥ ⑦ ⑧	■	10
A2617025106120	P2ZY 2510.06	120	2	25	10	6	40	① ② ③ ④ ⑤ ⑥ ⑦ ⑧	■	10
A2617032106120	P2ZY 3210.06	120	2	32	10	6	40	① ② ③ ④ ⑤ ⑥ ⑦ ⑧	■	10
A2617032106220	P2ZY 3210.06	220	2	32	10	6	40	① ② ③ ④ ⑤ ⑥ ⑦ ⑧	■	10
A2610032206120	P2ZY 3220.06	120	1	32	20	6	40	① ② ③ ④ ⑤ ⑥ ⑦ ⑧	■	10
A2610032326120	P2ZY 3232.06	120	1	32	32	6	40	① ② ③ ④ ⑤ ⑥ ⑦ ⑧	■	10
A2610032326280	P2ZY 3232.06	280	1	32	32	6	40	① ② ③ ④ ⑤ ⑥ ⑦ ⑧	■	10
A2617040106120	P2ZY 4010.06	120	2	40	10	6	40	① ② ③ ④ ⑤ ⑥ ⑦ ⑧	■	10
A2610040206120	P2ZY 4020.06	120	1	40	20	6	40	① ② ③ ④ ⑤ ⑥ ⑦ ⑧	■	10

Shape SP, Arch pointed nose (according to DIN 69170)

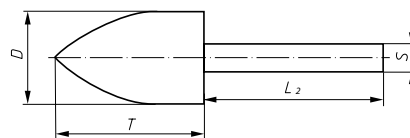

Ordering example: A2611013206120

Further dimensions and grit sizes on request

v_{max.}: 16 m/s

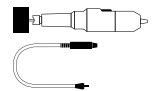

PG 3

Product number	Description	Grit	D mm	T mm	S mm	L ₂ mm	recommended for Information on page 438		
A2611013206120	P2SP 1320.06	120	13	20	6	40	① ② ③ ④ ⑤ ⑥ ⑦ ⑧	■	10
A2611020326220	P2SP 2032.06	220	20	32	6	40	① ② ③ ④ ⑤ ⑥ ⑦ ⑧	■	10

Shape KU, Spherical (according to DIN 69170)

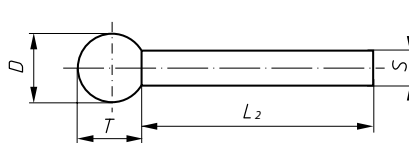

Ordering example: A2615008083120

Further dimensions and grit sizes on request

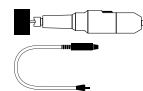
 $v_{max.}: 16 \text{ m/s}$

PG 3

Product number	Description	Grit	D mm	T mm	S mm	L ₂ mm	recommended for Information on page 438		
A2615008083120	P2KU 0808.03	120	8	8	3	30	① ② ③ ④ ⑤ ⑥ ⑦ ⑧	■	20
A2615010103120	P2KU 1010.03	120	10	10	3	30	① ② ③ ④ ⑤ ⑥ ⑦ ⑧	■	20
A2615016166120	P2KU 1616.06	120	16	16	6	40	① ② ③ ④ ⑤ ⑥ ⑦ ⑧	■	10
A2615016166220	P2KU 1616.06	220	16	16	6	40	① ② ③ ④ ⑤ ⑥ ⑦ ⑧	■	10

Shape WR, Cylindrical round nose (according to DIN 69170)

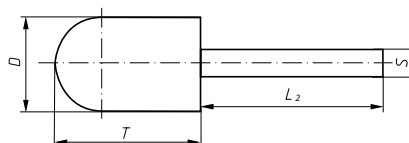

Ordering example: A2618016326120

Further dimensions and grit sizes on request

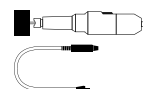
 $v_{max.}: 16 \text{ m/s}$

PG 3

Product number	Description	Grit	D mm	T mm	S mm	L ₂ mm	recommended for Information on page 438		
A2618016326120	P2WR 1632.06	120	16	32	6	40	① ② ③ ④ ⑤ ⑥ ⑦ ⑧	■	10

Shape KE, Conical round nose (according to DIN 69170)

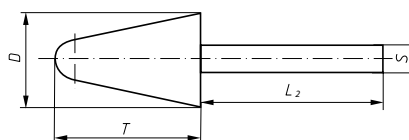

Ordering example: A2619010206080

Further dimensions and grit sizes on request

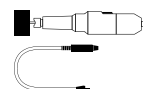
 $v_{max.}: 16 \text{ m/s}$

PG 3

Product number	Description	Grit	D mm	T mm	S mm	L ₂ mm	recommended for Information on page 438		
A2619010206080	P2KE 1020.06	80	10	20	6	40	① ② ③ ④ ⑤ ⑥ ⑦ ⑧	■	10
A2619010206120	P2KE 1020.06	120	10	20	6	40	① ② ③ ④ ⑤ ⑥ ⑦ ⑧	■	10

Felt polishing points, group P3

LUKAS felt polishing points are available in two specifications:

- H3 as per DIN 61200
- H3-S super hard and particularly effective when used in conjunction with diamond paste

The optimal peripheral speed for LUKAS felt polishing points is 2–8 m/s.

The LUKAS assortment of felt polishing tools reflects years of experience in this field and encompasses the most common shapes and sizes. Due to the extreme flexibility, felt polishing points together with LUKAS diamond paste are ideally suited for polishing exceptionally complex shapes e.g. pressure and injection moulds, drawing- press- and cutting tools, dies, bearings, spindles, rolls, gauges etc.

Grinding, Polishing (bonded)

Shape ZY, Cylindrical

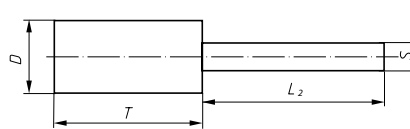

Ordering example: A3700006103
Further dimensions on request

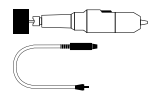

								PG 3	
Product number	Description	Quality	D mm	T mm	S mm	L ₂ mm	recommended for Information on page 438		
A3700006103	P3ZY 0610.03	H3	6	10	3	40	① ② ③ ④ ⑤ ⑥ ⑦ ⑧ ⑨	■	20
A37000061030001	P3ZY 0610.03	H3-S	6	10	3	40	① ② ③ ④ ⑤ ⑥ ⑦ ⑧ ⑨	■	20
A3700008103	P3ZY 0810.03	H3	8	10	3	40	① ② ③ ④ ⑤ ⑥ ⑦ ⑧ ⑨	■	20
A37000081030001	P3ZY 0810.03	H3-S	8	10	3	40	① ② ③ ④ ⑤ ⑥ ⑦ ⑧ ⑨	■	20
A3700010123	P3ZY 1012.03	H3	10	12	3	38	① ② ③ ④ ⑤ ⑥ ⑦ ⑧ ⑨	■	20
A37000101230001	P3ZY 1012.03	H3-S	10	12	3	38	① ② ③ ④ ⑤ ⑥ ⑦ ⑧ ⑨	■	20
A3700010156	P3ZY 1015.06	H3	10	15	6	40	① ② ③ ④ ⑤ ⑥ ⑦ ⑧ ⑨	■	10
A37000101560001	P3ZY 1015.06	H3-S	10	15	6	40	① ② ③ ④ ⑤ ⑥ ⑦ ⑧ ⑨	■	10
A3700012153	P3ZY 1215.03	H3	12	15	3	40	① ② ③ ④ ⑤ ⑥ ⑦ ⑧ ⑨	■	20
A37000121530001	P3ZY 1215.03	H3-S	12	15	3	40	① ② ③ ④ ⑤ ⑥ ⑦ ⑧ ⑨	■	20
A3700012206	P3ZY 1220.06	H3	12	20	6	40	① ② ③ ④ ⑤ ⑥ ⑦ ⑧ ⑨	■	10
A37000122060001	P3ZY 1220.06	H3-S	12	20	6	40	① ② ③ ④ ⑤ ⑥ ⑦ ⑧ ⑨	■	10
A3700016206	P3ZY 1620.06	H3	16	20	6	40	① ② ③ ④ ⑤ ⑥ ⑦ ⑧ ⑨	■	10
A3700020256	P3ZY 2025.06	H3	20	25	6	40	① ② ③ ④ ⑤ ⑥ ⑦ ⑧ ⑨	■	10
A37000202560001	P3ZY 2025.06	H3-S	20	25	6	40	① ② ③ ④ ⑤ ⑥ ⑦ ⑧ ⑨	■	10
A3700025306	P3ZY 2530.06	H3	25	30	6	40	① ② ③ ④ ⑤ ⑥ ⑦ ⑧ ⑨	■	10
A3700030406	P3ZY 3040.06	H3	30	40	6	40	① ② ③ ④ ⑤ ⑥ ⑦ ⑧ ⑨	■	10

Shape SP, Arch pointed nose

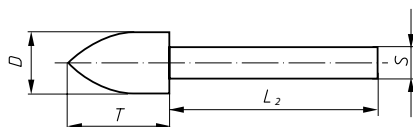

Ordering example: A3701006103

Further dimensions on request

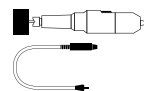

PG 3

Product number	Description	Quality	D mm	T mm	S mm	L ₂ mm	recommended for Information on page 438		
A3701006103	P3SP 0610.03	H3	6	10	3	40	① ② ③ ④ ⑤ ⑥ ⑦ ⑨	■	20
A3701008103	P3SP 0810.03	H3	8	10	3	40	① ② ③ ④ ⑤ ⑥ ⑦ ⑨	■	20
A3701010123	P3SP 1012.03	H3	10	12	3	40	① ② ③ ④ ⑤ ⑥ ⑦ ⑨	■	20
A3701010156	P3SP 1015.06	H3	10	15	6	40	① ② ③ ④ ⑤ ⑥ ⑦ ⑨	■	10
A3701012206	P3SP 1220.06	H3	12	20	6	40	① ② ③ ④ ⑤ ⑥ ⑦ ⑨	■	10
A3701020256	P3SP 2025.06	H3	20	25	6	40	① ② ③ ④ ⑤ ⑥ ⑦ ⑨	■	10
A3701025306	P3SP 2530.06	H3	25	30	6	40	① ② ③ ④ ⑤ ⑥ ⑦ ⑨	■	10
A3701030406	P3SP 3040.06	H3	30	40	6	40	① ② ③ ④ ⑤ ⑥ ⑦ ⑨	■	10

Shape KU, Spherical

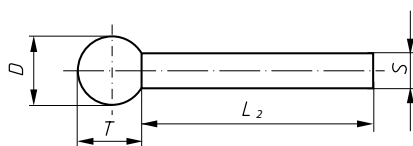

Ordering example: A3703006063

Further dimensions on request

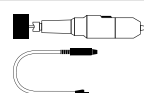

PG 3

Product number	Description	Quality	D mm	T mm	S mm	L ₂ mm	recommended for Information on page 438		
A3703006063	P3KU 0605.03	H3	6	5,5	3	39,5	① ② ③ ④ ⑤ ⑥ ⑦ ⑨	■	20
A3703008083	P3KU 0807.03	H3	8	7,5	3	42,5	① ② ③ ④ ⑤ ⑥ ⑦ ⑨	■	20
A3703010103	P3KU 1009.03	H3	10	9	3	41	① ② ③ ④ ⑤ ⑥ ⑦ ⑨	■	20
A3703010106	P3KU 1009.06	H3	10	9	6	41	① ② ③ ④ ⑤ ⑥ ⑦ ⑨	■	10
A3703012126	P3KU 1211.06	H3	12	11	6	39	① ② ③ ④ ⑤ ⑥ ⑦ ⑨	■	10
A3703020206	P3KU 2019.06	H3	20	19	6	41	① ② ③ ④ ⑤ ⑥ ⑦ ⑨	■	10

Shape KE, Conical round nose



Grinding, Polishing
(bonded)

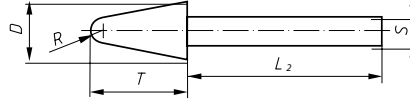

Ordering example: A3705010123

Further dimensions on request

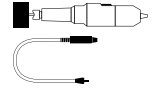

PG 3

Product number	Description	Quality	D mm	T mm	S mm	L ₂ mm	R mm	recommended for Information on page 438		
A3705010123	P3KE 1012.03	H3	10	12	3	38	2,5	① ② ③ ④ ⑤ ⑥ ⑦ ⑧ ⑨	■	20
A3705010156	P3KE 1015.06	H3	10	15	6	40	2,5	① ② ③ ④ ⑤ ⑥ ⑦ ⑧ ⑨	■	10
A37050101560001	P3KE 1015.06	H3-S	10	15	6	40	2,5	① ② ③ ④ ⑤ ⑥ ⑦ ⑧ ⑨	■	10
A3705016206	P3KE 1620.06	H3	16	20	6	40	3	① ② ③ ④ ⑤ ⑥ ⑦ ⑧ ⑨	■	10
A3705020256	P3KE 2025.06	H3	20	25	6	40	3,5	① ② ③ ④ ⑤ ⑥ ⑦ ⑧ ⑨	■	10
A3705025306	P3KE 2530.06	H3	25	30	6	40	4,5	① ② ③ ④ ⑤ ⑥ ⑦ ⑧ ⑨	■	10
A3705030406	P3KE 3040.06	H3	30	40	6	40	6,5	① ② ③ ④ ⑤ ⑥ ⑦ ⑧ ⑨	■	10

Application example P3



Shape S1, Wheels

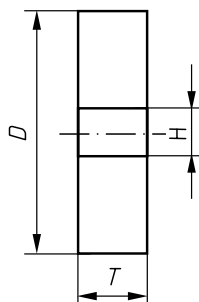

Ordering example: A3750040106

Further dimensions on request

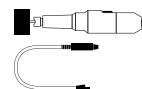

PG 3

Product number	Description	Quality	D mm	T mm	H mm	recommended for Information on page 438		
A3750040106	P3S1 4010.06	H3	40	10	6	1 2 3 4 5 6 7 9	■	10
A3750050106	P3S1 5010.06	H3	50	10	6	1 2 3 4 5 6 7 9	■	10
A3750050206	P3S1 5020.06	H3	50	20	6	1 2 3 4 5 6 7 9	■	10
A3750060106	P3S1 6010.06	H3	60	10	6	1 2 3 4 5 6 7 9	■	10
A3750060206	P3S1 6020.06	H3	60	20	6	1 2 3 4 5 6 7 9	■	10

Arbors for felt polishing wheels

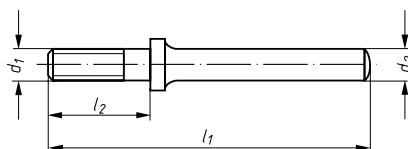

Ordering example: A1630780

The delivery includes for each stud

- 2 washers Ø 18 mm
- 2 washers Ø 30 mm
- 1 hex nut

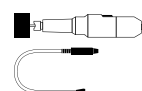

PG 8

Product number	Description	d ₁ mm	l ₂ mm	d ₂ mm	l ₁ mm	n max. (1/min)	recommended for Information on page 438		
A1630780	ASB 780	M6	20	6	63	7.000		■	5
A1630781	ASB 781	M6	30	6	73	7.000		■	5

Specification and application of diamond pastes

Diamond paste Super-E

Thanks to the high concentration of diamond grains, you can polish even the hardest materials quickly and economically. The optimal shape of the monocrystalline diamonds and the very narrow grain-size distribution guarantee perfect polishing results. Because of its agglomerate-free production and high viscosity – which can be thinned to any degree with water, oil or alcohol – our diamond paste is also ideal for use in machines. The paste was specially developed for mould making.

Features:

- high grain concentration
- perfect grain shape
- free from agglomerates
- narrow grain-size distribution
- monocrystalline
- high viscosity

Benefits/uses:

- polishes the hardest materials quickly and economically
- optimised for machine application
- highly effective
- ideal for mould making
- thin with water, oil or alcohol



Grinding compound



Ordering example: A3760120

Contents: 250 g



PG 13

Product number	Description	Quality	Grit	µm	recommended for Information on page 438		
A3760120	SP-1	medium	120	88 - 125	1 2 3 4 5 6 7	■	1
A3760180	SP-2	fine	180	55 - 88	1 2 3 4 5 6 7	■	1
A3760320	SP-3	very fine	320	20 - 40	1 2 3 4 5 6 7	■	1

Ingredient: silicon carbide paste, oil-soluble, can be used with thinners, cleaned with oil, spirit or petrol

Application: For polishing pre-ground surfaces; particularly suited for hard metallic surfaces e.g. steel, iron, cast iron, bronze, brass and copper

Diamond pastes



Ordering example: A3410119105



PG 13

Product number	Description	Quality	Grit size µ	Colour of paste	Contents	recommended for Information on page 438		
A3410119105	E-091	Super-E	1	blue	5 g	1 2 3 4 5 6 7 9	■	1
A3410119110	E-091	Super-E	1	blue	10 g	1 2 3 4 5 6 7 9	■	1
A3410119205	E-092	Super-E	3	green	5 g	1 2 3 4 5 6 7 9	■	1
A3410119210	E-092	Super-E	3	green	10 g	1 2 3 4 5 6 7 9	■	1
A3410119305	E-093	Super-E	6	yellow	5 g	1 2 3 4 5 6 7 9	■	1
A3410119310	E-093	Super-E	6	yellow	10 g	1 2 3 4 5 6 7 9	■	1
A3410119405	E-094	Super-E	9	red	5 g	1 2 3 4 5 6 7 9	■	1
A3410119410	E-094	Super-E	9	red	10 g	1 2 3 4 5 6 7 9	■	1
A3410119505	E-095	Super-E	15	pale brown	5 g	1 2 3 4 5 6 7 9	■	1
A3410119510	E-095	Super-E	15	pale brown	10 g	1 2 3 4 5 6 7 9	■	1

Specification and application P4

Tools within this group are bonded with polyurethane (PU) and are manufactured in various hardnesses. They contain a mixture of abrasive grain (aluminium oxide, silicon carbide) and fillers. To optically differentiate between qualities, these tools are colour coded. Products in this group have a relatively dense structure. Pores

resulting from the manufacturing process are of no detriment. A range of flexibility from soft to hard relating to the cross section are available. These polishing sticks are mainly used manually for mould manufacture.

Colour	Quality	Colour	Quality	Colour	Quality
pale grey	SiC 80 soft	pale green	SiC 240 soft	pale red	EKW 150 soft
gray	SiC 80 hard	green	SiC 240 hard	red	EKW 150 hard
pale blue	SiC 150 soft	beige	EKW 80 soft	pale brown	EKW 240 soft
blue	SiC 150 hard	dark beige	EKW 80 hard	brown	EKW 240 hard

Polishing sticks, flat

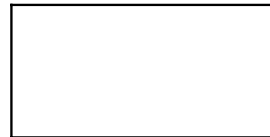

Ordering example: P4SF 0612.070

Further dimensions on request

All items are available within a few days ex-intermediate stock.

Description	H mm	B mm	L mm	recommended for Information on page 438	PG 3	
					▲	📦
P4SF 0612.070	6	12	70	① ② ③ ④ ⑤ ⑥ ⑦	▲	10
P4SF 0612.140	6	12	140	① ② ③ ④ ⑤ ⑥ ⑦	▲	10
P4SF 0816.070	8	16	70	① ② ③ ④ ⑤ ⑥ ⑦	▲	10
P4SF 0816.140	8	16	140	① ② ③ ④ ⑤ ⑥ ⑦	▲	10
P4SF 0816.210	8	16	210	① ② ③ ④ ⑤ ⑥ ⑦	▲	10
P4SF 1020.070	10	20	70	① ② ③ ④ ⑤ ⑥ ⑦	▲	10
P4SF 1020.140	10	20	140	① ② ③ ④ ⑤ ⑥ ⑦	▲	10
P4SF 1020.210	10	20	210	① ② ③ ④ ⑤ ⑥ ⑦	▲	10
P4SF 1020.280	10	20	280	① ② ③ ④ ⑤ ⑥ ⑦	▲	10

Polishing sticks, round

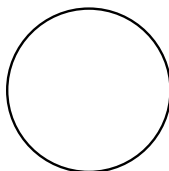

Ordering example: P4SR 0006.70

Further dimensions on request

All items are available within a few days ex-intermediate stock.



PG 3

Description	Ø mm	L mm	recommended for Information on page 438		
P4SR 0006.070	6	70	① ② ③ ④ ⑤ ⑥ ⑦	▲	10
P4SR 0006.140	6	140	① ② ③ ④ ⑤ ⑥ ⑦	▲	10
P4SR 0010.140	10	140	① ② ③ ④ ⑤ ⑥ ⑦	▲	10
P4SR 0010.210	10	210	① ② ③ ④ ⑤ ⑥ ⑦	▲	10
P4SR 0010.070	10	70	① ② ③ ④ ⑤ ⑥ ⑦	▲	10
P4SR 0012.070	12	70	① ② ③ ④ ⑤ ⑥ ⑦	▲	10
P4SR 0012.140	12	140	① ② ③ ④ ⑤ ⑥ ⑦	▲	10
P4SR 0012.210	12	210	① ② ③ ④ ⑤ ⑥ ⑦	▲	10
P4SR 0012.280	12	280	① ② ③ ④ ⑤ ⑥ ⑦	▲	10
P4SR 0015.070	15	70	① ② ③ ④ ⑤ ⑥ ⑦	▲	10
P4SR 0015.140	15	140	① ② ③ ④ ⑤ ⑥ ⑦	▲	10
P4SR 0015.210	15	210	① ② ③ ④ ⑤ ⑥ ⑦	▲	10
P4SR 0015.280	15	280	① ② ③ ④ ⑤ ⑥ ⑦	▲	10

Polishing sticks, square



Ordering example: P4SV 0606.070

Further dimensions on request

All items are available within a few days ex-intermediate stock.



PG 3

Description	H mm	B mm	L mm	recommended for Information on page 438		
P4SV 0606.070	6	6	070	① ② ③ ④ ⑤ ⑥ ⑦	▲	10
P4SV 0606.140	6	6	140	① ② ③ ④ ⑤ ⑥ ⑦	▲	10
P4SV 1010.070	10	10	70	① ② ③ ④ ⑤ ⑥ ⑦	▲	10
P4SV 1010.140	10	10	140	① ② ③ ④ ⑤ ⑥ ⑦	▲	10
P4SV 1010.210	10	10	210	① ② ③ ④ ⑤ ⑥ ⑦	▲	10
P4SV 1212.140	12	12	140	① ② ③ ④ ⑤ ⑥ ⑦	▲	10
P4SV 1212.210	12	12	210	① ② ③ ④ ⑤ ⑥ ⑦	▲	10
P4SV 1515.070	15	15	070	① ② ③ ④ ⑤ ⑥ ⑦	▲	10
P4SV 1515.140	15	15	140	① ② ③ ④ ⑤ ⑥ ⑦	▲	10
P4SV 1515.210	15	15	210	① ② ③ ④ ⑤ ⑥ ⑦	▲	10
P4SV 1515.280	15	15	280	① ② ③ ④ ⑤ ⑥ ⑦	▲	10

Specification and application P5

The polishing points of this group are characterized by their special structure and bonding i.e. fibre reinforced. This makes them ideally suited for fine finishing of aluminium and associated alloys, non-ferrous metals and low and high alloyed steels. Due to the fibre reinforcement, these tools have exceptional edge-fray

resistance and stability. Polishing points in group P5 are available in grit sizes detailed below; they are identified with a red marking.



Colour	black	pale grey	red
Grit	46	80	120

Shape ZY, Cylindrical (according to DIN 69170)



Ordering example: A2620004083080

Further dimensions and grit sizes on request

$v_{max.}: 50 \text{ m/s}$

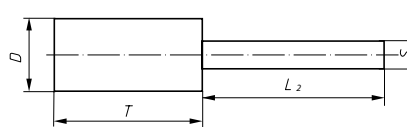
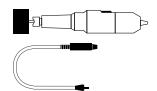

PG 3

Product number	Description	Grit	D mm	T mm	S mm	L ₂ mm	recommended for Information on page 438		
A2620004083080	P5ZY 0408.03	80	4	8	3	30	① ② ③ ④ ⑤ ⑥ ⑦	■	20
A2620004083120	P5ZY 0408.03	120	4	8	3	30	① ② ③ ④ ⑤ ⑥ ⑦	■	20
A2620005103080	P5ZY 0510.03	80	5	10	3	30	① ② ③ ④ ⑤ ⑥ ⑦	■	20
A2620005103120	P5ZY 0510.03	120	5	10	3	30	① ② ③ ④ ⑤ ⑥ ⑦	■	20
A2620006103080	P5ZY 0610.03	80	6	10	3	30	① ② ③ ④ ⑤ ⑥ ⑦	■	20
A2620006103120	P5ZY 0610.03	120	6	10	3	30	① ② ③ ④ ⑤ ⑥ ⑦	■	20
A2620008103080	P5ZY 0810.03	80	8	10	3	30	① ② ③ ④ ⑤ ⑥ ⑦	■	20
A2620008103120	P5ZY 0810.03	120	8	10	3	30	① ② ③ ④ ⑤ ⑥ ⑦	■	20
A2620008166046	P5ZY 0816.06	46	8	16	6	30	① ② ③ ④ ⑤ ⑥ ⑦	■	10
A2620008166080	P5ZY 0816.06	80	8	16	6	30	① ② ③ ④ ⑤ ⑥ ⑦	■	10

Shape ZY, Cylindrical (according to DIN 69170)

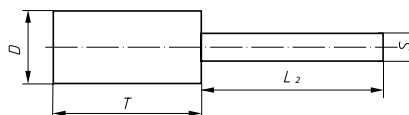

Ordering example: A2620004083080

Further dimensions and grit sizes on request

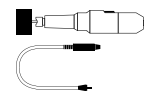
 $v_{max.}: 50 \text{ m/s}$

Grinding, Polishing (bonded)



PG 3

Product number	Description	Grit	D mm	T mm	S mm	L ₂ mm	recommended for Information on page 438		
A2620008166120	P5ZY 0816.06	120	8	16	6	40	1 2 3 4 5 6 7	■	10
A2620010103080	P5ZY 1010.03	80	10	10	3	30	1 2 3 4 5 6 7	■	20
A2620010103120	P5ZY 1010.03	120	10	10	3	30	1 2 3 4 5 6 7	■	20
A2620010206046	P5ZY 1020.06	46	10	20	6	40	1 2 3 4 5 6 7	■	10
A2620010206080	P5ZY 1020.06	80	10	20	6	40	1 2 3 4 5 6 7	■	10
A2620010206120	P5ZY 1020.06	120	10	20	6	40	1 2 3 4 5 6 7	■	10
A2620013133120	P5ZY 1313.03	120	13	13	3	30	1 2 3 4 5 6 7	■	20
A2620013163080	P5ZY 1316.03	80	13	16	3	30	1 2 3 4 5 6 7	■	20
A2620013206080	P5ZY 1320.06	80	13	20	6	40	1 2 3 4 5 6 7	■	10
A2620013206120	P5ZY 1320.06	120	13	20	6	40	1 2 3 4 5 6 7	■	10
A2620016206080	P5ZY 1620.06	80	16	20	6	40	1 2 3 4 5 6 7	■	10
A2620016206120	P5ZY 1620.06	120	16	20	6	40	1 2 3 4 5 6 7	■	10
A2620016326046	P5ZY 1632.06	46	16	32	6	40	1 2 3 4 5 6 7	■	10
A2620016326080	P5ZY 1632.06	80	16	32	6	40	1 2 3 4 5 6 7	■	10
A2620020206080	P5ZY 2020.06	80	20	20	6	40	1 2 3 4 5 6 7	■	10
A2620020326046	P5ZY 2032.06	46	20	32	6	40	1 2 3 4 5 6 7	■	10
A2620020326120	P5ZY 2032.06	120	20	32	6	40	1 2 3 4 5 6 7	■	10
A2620032326080	P5ZY 3232.06	80	32	32	6	40	1 2 3 4 5 6 7	■	10
A2620040166120	P5ZY 4016.06	120	40	16	6	40	1 2 3 4 5 6 7	■	10

Shape SP, Arch pointed nose (according to DIN 69170)



Grinding, Polishing
(bonded)

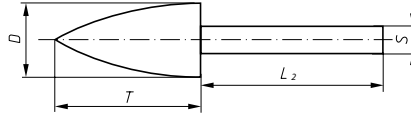

Ordering example: A2621020326080

Further dimensions and grit sizes on request.

$v_{max.}$: 50 m/s

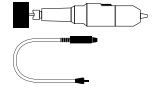

PG 3

Product number	Description	Grit	D mm	T mm	S mm	L ₂ mm	recommended for Information on page 438		
A2621020326080	P5SP 2032.06	80	20	32	6	40	<input checked="" type="checkbox"/> 1 <input checked="" type="checkbox"/> 2 <input checked="" type="checkbox"/> 3 <input checked="" type="checkbox"/> 4 <input checked="" type="checkbox"/> 5 <input checked="" type="checkbox"/> 6 <input checked="" type="checkbox"/> 7	■	10

Shape KU, Spherical (according to DIN 69170)

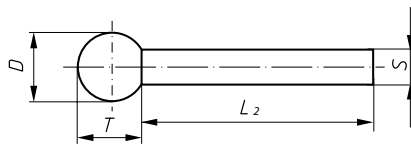

Ordering example: A2625008083080

Further dimensions and grit sizes on request.

$v_{max.}$: 50 m/s

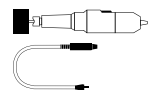

PG 3

Product number	Description	Grit	D mm	T mm	S mm	L ₂ mm	recommended for Information on page 438		
A2625008083080	P5KU 0808.03	80	8	8	3	30	<input checked="" type="checkbox"/> 1 <input checked="" type="checkbox"/> 2 <input checked="" type="checkbox"/> 3 <input checked="" type="checkbox"/> 4 <input checked="" type="checkbox"/> 5 <input checked="" type="checkbox"/> 6 <input checked="" type="checkbox"/> 7	■	20

Specification and application P6

Products in group P6 are manufactured with a polyurethane bond (PU) in different hardnesses.

These tools

- can be easily profiled
- quickly generate an excellent surface finish
- produce little heat during the polishing process
- do not load
- require no dressing
- contain no softener
- do not increase in hardness after long storage
- are ideal for both stationary and manual application

These polishing tools are used to improve surface finish and geometry. The main applications are the polishing and finishing of steel, brass, precious metals, sintered metals and plastic. They can be used with or without coolant.

For dressing, a dressing stick (page 124) or diamond dressing tool can be used.

Due to long tool life and a good edge-fray resistance, the tools are ideally suited for automated processes e.g. centerless polishing of tubes or marbling of high alloyed steel plates.

The following grades are available:

- WP** = soft, very flexible
- MWP** = medium to soft
- MP** = medium for general application
- HP** = hard, resilient for flat surfaces
- SHP** = super hard, for stationary applications

The bonding is mixed with silicon carbide "SIC", Aluminium oxide white or aluminium oxide "A" grain in the FEPA grit sizes 24 to 1200.

Application examples marbling points P6



Application recommendations polishing tools P6

Grinding, Polishing (bonded)

	Removing rust, cleaning, tarnish removal	Cylindrical and surface grinding	Sharpening, dressing	Marbling, matt finishing		Deburring, cleaning up and rounding off				Burnishing				Pre-finishing				Polishing	
	MWP	SHP	SHP	WP	MWP	WP	MWP	MP	HP	WP	MWP	MP	HP	WP	MWP	MP	HP	WP	MWP
Gold, silver, nickel, aluminium, copper, brass																		400	400
															240	240			
																150			
																120	120		
						80			80	80						80			
					46	46				46						46			
Constructional steel	46																		
Stainless steel, Titanium			400															400	400
			240													240	240		240
									150							150	150		
			120								120	120				120			
			80		80	80	80		80	80	80	80	80						
					46		46				46	46	46	46					
					24				24										
Hardened steel, Carbide		240															240		
		150											150						
		120											120						
		80					80												
							46												
Glass															400				
															240				
															150				
							80												
Rubber												46							
Wood												80							
Paint	46											80							
Solder	240																		
Tin													80						
													46						

Grit sizes

Polishing wheels, Shape SE 1

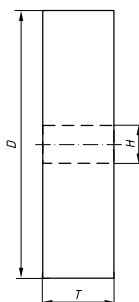
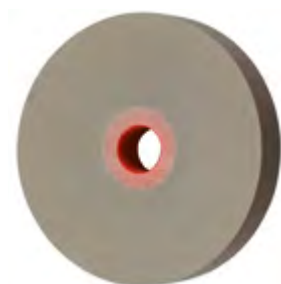

Ordering example: A29100600060041

Further dimensions and grit sizes on request

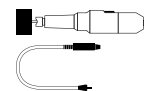
 $v_{max.}$: MWP = 20 m/s
 WP = 16 m/s
 SHP = 32 m/s

PG 4

Product number	Description	Quality / Grit	D mm	T mm	H mm	recommended for Information on page 438		
A29100600060041	P6SE1 06006 B.06	SC 80 MWP	60	6	6	1 2 3 4 5 6 7 9	■	1
A29100600060061	P6SE1 06006 B.06	SC 150 MWP	60	6	6	1 2 3 4 5 6 7 9	■	1
A29101000100041	P6SE1 10010 B.25	SC 80 MWP	100	10	25	1 2 3 4 5 6 7 9	■	1
A29101000200021	P6SE1 10020 B.25	SC 46 MWP	100	20	25	1 2 3 4 5 6 7 9	■	1
A29101000200041	P6SE1 10020 B.25	SC 80 MWP	100	20	25	1 2 3 4 5 6 7 9	■	1
A29101000200061	P6SE1 10020 B.25	SC 150 MWP	100	20	25	1 2 3 4 5 6 7 9	■	1
A29101000200091	P6SE1 10020 B.25	SC 400 MWP	100	20	25	1 2 3 4 5 6 7 9	■	1
A29101250100041	P6SE1 12510 B.25	SC 80 MWP	125	10	25	1 2 3 4 5 6 7 9	■	1
A29101250100061	P6SE1 12510 B.25	SC 150 MWP	125	10	25	1 2 3 4 5 6 7 9	■	1
A29101250200041	P6SE1 12520 B.25	SC 80 MWP	125	20	25	1 2 3 4 5 6 7 9	■	1
A29101250200061	P6SE1 12520 B.25	SC 150 MWP	125	20	25	1 2 3 4 5 6 7 9	■	1
A29101500100061	P6SE1 15010 B.25	SC 150 MWP	150	10	25	1 2 3 4 5 6 7 9	■	1
A29101500100069	P6SE1 15010 B.25	SC 150 SHP	150	10	25	1 2 3 4 5 6 7 9	■	1
A29101500150059	P6SE1 15015 B.20	SC 120 SHP	150	15	20	1 2 3 4 5 6 7 9	■	1
A29101500200040	P6SE1 15020 B.25	SC 80 WP	150	20	25	1 2 3 4 5 6 7 9	■	1
A29101500200041	P6SE1 15020 B.25	SC 80 MWP	150	20	25	1 2 3 4 5 6 7 9	■	1
A29101500200061	P6SE1 15020 B.25	SC 150 MWP	150	20	25	1 2 3 4 5 6 7 9	■	1
A29101500250021	P6SE1 15025 B.20	SC 46 MWP	150	25	20	1 2 3 4 5 6 7 9	■	1
A29101500250040	P6SE1 15025 B.25	SC 80 WP	150	25	25	1 2 3 4 5 6 7 9	■	1
A29101500250061	P6SE1 15025 B.25	SC 150 MWP	150	25	25	1 2 3 4 5 6 7 9	■	1
A29101500250074	P6SE1 15025 B.20	SC 240 MP	150	25	20	1 2 3 4 5 6 7 9	■	1
A29102000250041	P6SE1 20025 B.25	SC 80 MWP	200	25	25	1 2 3 4 5 6 7 9	■	1
A29102000250061	P6SE1 20025 B.25	SC 150 MWP	200	25	25	1 2 3 4 5 6 7 9	■	1

These polishing wheels are supplied in a medium bond in the two grit sizes 80 and 150. Upon request these polishing wheels can also be delivered with the bonding HP ($v_{max.}$ 32 m/s) or MP ($v_{max.}$ 25 m/s).

Safety instructions: Grinding and polishing wheels on stationary machines are to be used only from both sides with the appropriate flanges. The diameter of flange must be 2/3 of the wheel diameter. The flanges are provided with a recess (1–2 mm depth) up to 5–10 mm from the outer edge.

Mounting system for polishing wheels

★★☆

Ordering example: A6981008000



PG 7

Product number	Description	recommended for Information on page 438	
A6981008000	Mounting system MCA+ K25		<div style="display: flex; align-items: center;"> ■ 1 </div>

The mounting system for polishing wheels consists of a plastic sleeve (MCA) and a mounting arbor with 8 mm diameter shank (K25) which is solely applicable to shape SE1 in the dimensions 10010 B 25 and 10020 B 25. It is not permitted to use this mounting system for polishing wheels with larger diameters. Maximum peripheral wheel speed using this mounting method is 10m/s; this means a maximum spindle speed of 1900 R.P.M. with a wheel diameter of 100 mm.

Marbling points, Shape ZY, Cylinder

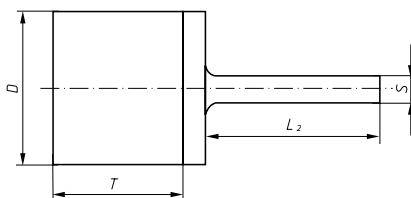

Ordering example: A29200200306021

Further dimensions and grit sizes on request

v_{max.}: 10 m/s

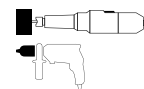

PG 4

Product number	Description	Quality / Grit	D mm	T mm	S mm	L ₂ mm	recommended for Information on page 438										
A29200200306021	P6MA ZY 2030.06	SC 46 MWP	20	30	6	35	1	2	3	4	5	6	7	9	■	1	
A29200300306021	P6MA ZY 3030.06	SC 46 MWP	30	30	6	35	1	2	3	4	5	6	7	9	■	1	
A29200400306046	P6MA ZY 4030.06	SC 46 MWP	40	30	6	35	1	2	3	4	5	6	7	9	■	1	
A29200500306046	P6MA ZY 5030.06	SC 46 MWP	50	30	6	35	1	2	3	4	5	6	7	9	■	1	
A29200500306034	P6MA ZY 5030.06	SC 60 MP	50	30	6	35	1	2	3	4	5	6	7	9	■	1	
A29200600306046	P6MA ZY 6030.06	SC 46 MWP	60	30	6	35	1	2	3	4	5	6	7	9	■	1	

The marbling points can be used to work stainless steels, aluminium and non-ferrous metals (peacock-eye, clouds).

The marbling points do not load with abrasive dust and their quality lasts up to the plastic cap.

Polishing points, Shape ZY, Cylindrical



Grinding, Polishing
(bonded)

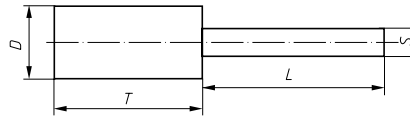

Ordering example: A29300080103048

Further dimensions and grit sizes on request.

v_{max.}: 20 m/s

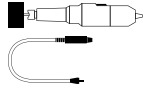

								PG 4										
Product number	Description	Quality/Grit	D mm	T mm	S mm	L mm	recommended for	Information on page 438										
A29300080103048	P6ZY 0810.03	SC 80 HP	8	10	3	30	1	2	3	4	5	6	7	9	■	10		
A29300080103068	P6ZY 0810.03	SC 150 HP	8	10	3	30	1	2	3	4	5	6	7	9	■	10		
A29300080103078	P6ZY 0810.03	SC 240 HP	8	10	3	30	1	2	3	4	5	6	7	9	■	10		
A29300080163048	P6ZY 0816.03	SC 80 HP	8	16	3	30	1	2	3	4	5	6	7	9	■	10		
A29300080163068	P6ZY 0816.03	SC 150 HP	8	16	3	30	1	2	3	4	5	6	7	9	■	10		
A29300080163078	P6ZY 0816.03	SC 240 HP	8	16	3	30	1	2	3	4	5	6	7	9	■	10		
A29300100103048	P6ZY 1010.03	SC 80 HP	10	10	3	30	1	2	3	4	5	6	7	9	■	10		
A29300100103068	P6ZY 1010.03	SC 150 HP	10	10	3	30	1	2	3	4	5	6	7	9	■	10		
A29300100103078	P6ZY 1010.03	SC 240 HP	10	10	3	30	1	2	3	4	5	6	7	9	■	10		
A29300100203048	P6ZY 1020.03	SC 80 HP	10	20	3	30	1	2	3	4	5	6	7	9	■	10		
A29300100203068	P6ZY 1020.03	SC 150 HP	10	20	3	30	1	2	3	4	5	6	7	9	■	10		
A29300100203078	P6ZY 1020.03	SC 240 HP	10	20	3	30	1	2	3	4	5	6	7	9	■	10		
A29300130203048	P6ZY 1320.03	SC 80 HP	13	20	3	30	1	2	3	4	5	6	7	9	■	10		
A29300160203028	P6ZY 1620.03	SC 46 HP	16	20	3	30	1	2	3	4	5	6	7	9	■	10		
A29300160203048	P6ZY 1620.03	SC 80 HP	16	20	3	30	1	2	3	4	5	6	7	9	■	10		
A29300160203068	P6ZY 1620.03	SC 150 HP	16	20	3	30	1	2	3	4	5	6	7	9	■	10		
A29300160203078	P6ZY 1620.03	SC 240 HP	16	20	3	40	1	2	3	4	5	6	7	9	■	10		
A69300160203094	P6ZY 1620.03	SC 400 MP	16	20	3	40	1	2	3	4	5	6	7	9	■	10		
A693001602030H0	P6ZY 1620.03	SC 800 WP	16	20	3	40	1	2	3	4	5	6	7	9	■	10		
A29300200206028	P6ZY 2020.06	SC 46 HP	20	20	6	40	1	2	3	4	5	6	7	9	■	10		
A29300200206068	P6ZY 2020.06	SC 150 HP	20	20	6	40	1	2	3	4	5	6	7	9	■	10		
A69300200306044	P6ZY 2030.06	SC 80 MP	20	30	6	40	1	2	3	4	5	6	7	9	■	10		
A29300250206048	P6ZY 2520.06	SC 80 HP	25	20	6	40	1	2	3	4	5	6	7	9	■	10		
A29300300306028	P6ZY 3030.06	SC 46 HP	30	30	6	40	1	2	3	4	5	6	7	9	■	10		
A29300300306068	P6ZY 3030.06	SC 150 HP	30	30	6	40	1	2	3	4	5	6	7	9	■	10		
A29300300306078	P6ZY 3030.06	SC 240 HP	30	30	6	40	1	2	3	4	5	6	7	9	■	10		
A69300400306078	P6ZY 4030.06	SC 240 HP	40	30	6	40	1	2	3	4	5	6	7	9	■	10		
A29300400406028	P6ZY 4040.06	SC 46 HP	40	40	6	40	1	2	3	4	5	6	7	9	■	10		
A69300400406048	P6ZY 4040.06	SC 80 HP	40	40	6	40	1	2	3	4	5	6	7	9	■	10		
A69300400406064	P6ZY 4040.06	SC 150 MP	40	40	6	40	1	2	3	4	5	6	7	9	■	10		
A29300400406068	P6ZY 4040.06	SC 150 HP	40	40	6	40	1	2	3	4	5	6	7	9	■	10		
A69300400406091	P6ZY 4040.06	SC 400 MWP	40	40	6	40	1	2	3	4	5	6	7	9	■	10		
A29300500406028	P6ZY 5040.06	SC 46 HP	50	40	6	40	1	2	3	4	5	6	7	9	■	10		
A29300500406068	P6ZY 5040.06	SC 150 HP	50	40	6	40	1	2	3	4	5	6	7	9	■	10		
A29300600406028	P6ZY 6040.06	SC 46 HP	60	40	6	40	1	2	3	4	5	6	7	9	■	10		
A29300600406068	P6ZY 6040.06	SC 150 HP	60	40	6	40	1	2	3	4	5	6	7	9	■	10		

The polishing points are most suitable to work metal parts which are difficult or not accessible with grinding wheels.

Applications: Bores, fillet weldings, moulds tools

Polishing roll, P6PW

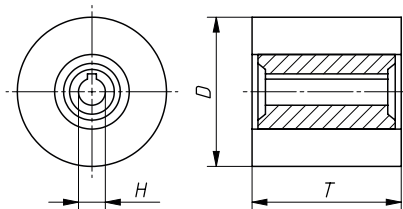

Ordering example: A29401000500041

Further dimensions and grit sizes on request

Machines to suit: page 376

v_{max.}: 16 m/s

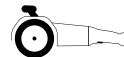

PG 4

Product number	Description	Quality / Grit	D mm	T mm	H mm	recommended for Information on page 438		
A29401000500041	P6PW 100050	SC 80 MWP	100	50	19	1 2 3 4 5 6 7 9	■	1
A29401001000011	P6PW 100100	SC 24 MWP	100	100	19	1 2 3 4 5 6 7 9	■	1
A29401001000020	P6PW 100100	SC 46 WP	100	100	19	1 2 3 4 5 6 7 9	■	1
A29401001000021	P6PW 100100	SC 46 MWP	100	100	19	1 2 3 4 5 6 7 9	■	1
A29401001000040	P6PW 100100	SC 80 WP	100	100	19	1 2 3 4 5 6 7 9	■	1
A29401001000041	P6PW 100100	SC 80 MWP	100	100	19	1 2 3 4 5 6 7 9	■	1

Polishing roll P6PW for the polishing machine
for perfectly brushed or dull-brushed surfaces

Set Polishing discs P6PT



Grinding, Polishing (bonded)

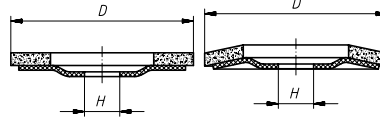

Ordering example: A6700023

v_{max.}: 32 m/s

SIC = Silicon carbide

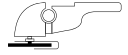

PG 4

Product number	Description	Quality	D mm	Contents	je 1	recommended for	Information on page 438		
A6700023	P6PT 125 (flat) SET	P6PT	125	4-pieces	P150, 240, 400, 800	1 2 3 4 5 6 7		■	1
A6700024	P6PT 125 (dished) SET	P6PT	125	4-pieces	P150, 240, 400, 800	1 2 3 4 5 6 7		■	1

Create extremely smooth surfaces – right up to mirror finish – very quickly on large surfaces.

Range of application:

- polishing of different surfaces
- cleaning and derusting
- removing paint and coatings
- replaces cloth discs, felt discs and polishing pastes

Benefits:

- for standard controlled angle grinders
- clean working conditions, as no abrasive paste is required
- rapid work progress

Polishing disc P6PT

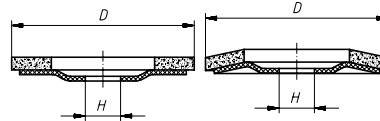

Ordering example: A671612515014

v_{max.}: 32 m/s

SIC = Silicon carbide

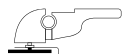

PG 4

Product number	Description	Quality	D mm	reinforced hardness	recommended for	Information on page 438		
A671612515014	P6PT 125 (flat)	SC 150 MP	125	medium	1 2 3 4 5 6 7		■	5
A671612515014001	P6PT 125 (flat)	SC 150 MWP	125	medium	1 2 3 4 5 6 7		■	5
A671612524014	P6PT 125 (flat)	SC 240 MWP	125	fine	1 2 3 4 5 6 7		■	5
A671612540014	P6PT 125 (flat)	SC 400 WP	125	very fine	1 2 3 4 5 6 7		■	5
A671612580014	P6PT 125 (flat)	SC 800 WP	125	ultra fine	1 2 3 4 5 6 7		■	5
A671712515014	P6PT 125 (dished)	SC 150 MP	125	medium	1 2 3 4 5 6 7		■	5
A671712524014	P6PT 125 (dished)	SC 240 MWP	125	fine	1 2 3 4 5 6 7		■	5
A671712540014	P6PT 125 (dished)	SC 400 WP	125	very fine	1 2 3 4 5 6 7		■	5
A671712580014	P6PT 125 (dished)	SC 800 WP	125	ultra fine	1 2 3 4 5 6 7		■	5
A6717125120014	P6PT 125 (dished)	SC 1200 WP	125	ultra fine	1 2 3 4 5 6 7		■	5

Polishing disc P6PT quality CG

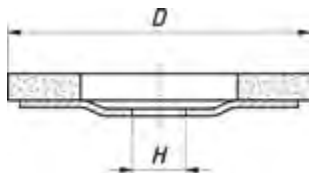

Ordering example: A671611506014

$v_{max.}$: 80 m/s

EKW = Aluminum oxide white



PG 4

Product number	Description	Quality	D mm	B mm	n max. (1/min)	recommended for Information on page 438									
A671611506014	P6PT 115 (flat)	EKW 60 SHP CG	115	22,23	13.300	1 2 3 4 5 6							■	5	
A671611512014	P6PT 115 (flat)	EKW 120 SHP CG	115	22,23	13.300	1 2 3 4 5 6							■	5	
A671612506014	P6PT 125 (flat)	EKW 60 SHP CG	125	22,23	12.200	1 2 3 4 5 6							■	5	
A671612512014	P6PT 125 (flat)	EKW 120 SHP CG	125	22,23	12.200	1 2 3 4 5 6							■	5	

Grinding, Polishing (bonded)

Polishing wheels, Shape SE1 CG

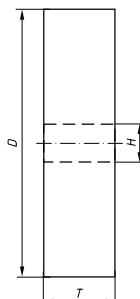

Ordering example: A29100800060B39

Further dimensions and grit sizes in request

$v_{max.}$: 63 m/s

EKW = Aluminum oxide white

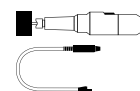

PG 4

Product number	Description	Quality/Grit	D mm	T mm	H mm	recommended for Information on page 438									
A29100800060B39	P6SE1 08006 B.06	EKW 60 SHP CG	80	6	6	1 2 3 4 5 6							■	20	
A29100800060B59	P6SE1 08006 B.06	EKW 120 SHP CG	80	6	6	1 2 3 4 5 6							■	20	
A29101500100B39	P6SE1 15010 B.25	EKW 60 SHP CG	150	10	25	1 2 3 4 5 6							■	10	
A29101500100B59	P6SE1 15010 B.25	EKW 120 SHP CG	150	10	25	1 2 3 4 5 6							■	10	
A29102000200B39	P6SE1 20020 B.25	EKW 60 SHP CG	200	20	25	1 2 3 4 5 6							■	10	
A29102000200B59	P6SE1 20020 B.25	EKW 120 SHP CG	200	20	25	1 2 3 4 5 6							■	10	

Polishing points, Cylindrical, Group P6 CG



★★★

Grinding, Polishing
(bonded)

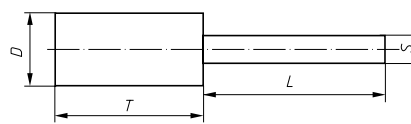

Ordering example: A29300130203B39

Further dimensions and grit sizes on request.

$v_{max.}$: 50 m/s

EKW = Aluminum oxide white

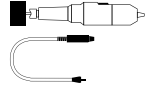

PG 4

Product number	Description	Quality/Grit	D mm	T mm	S mm	L mm	recommended for Information on page 438									
A29300130203B39	P6ZY 1320.03	EKW 60 SHP CG	13	20	3	30	1	2	3	4	5	6	7		■	10
A29300130203B59	P6ZY 1320.03	EKW 120 SHP CG	13	20	3	30	1	2	3	4	5	6	7		■	10
A29300160206B39	P6ZY 1620.06	EKW 60 SHP CG	16	20	6	40	1	2	3	4	5	6	7		■	10
A69300160206B59	P6ZY 1620.06	EKW 120 SHP CG	16	20	6	40	1	2	3	4	5	6	7		■	10
A69300200206B39	P6ZY 2020.06	EKW 60 SHP CG	20	20	6	40	1	2	3	4	5	6	7		■	10
A29300200206B59	P6ZY 2020.06	EKW 120 SHP CG	20	20	6	40	1	2	3	4	5	6	7		■	10
A29300300306B39	P6ZY 3030.06	EKW 60 SHP CG	30	30	6	40	1	2	3	4	5	6	7		■	10
A69300300306B59	P6ZY 3030.06	EKW 120 SHP CG	30	30	6	40	1	2	3	4	5	6	7		■	10

Specification and application P7

LUKAS polishing points, discs and lenses have been especially developed for intricate mechanical and laboratory use. The small

est dimensions in various shapes allow for the fine machining of intricate workpieces and structures.

Polishing discs and polishing lenses in a soft elastomer bonding

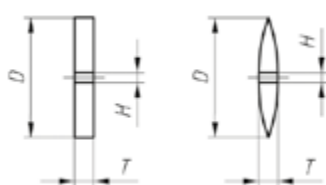

Ordering example: A2950000101007

Further dimensions and grit sizes on request

v_{max} : 16 m/s

Suitable mounting arbors on request

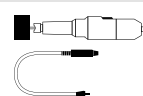

PG 4

Product number	Description	Quality	Shape	D mm	T mm	H mm	recommended for		
A2950000101007	P7- R22	SICGR 240		22	3,5	1,8	Information on page 438	1 2 3 4 5 6 7 9	■ 100
A2950000105007	P7- L22	SICGR 240		22	3,4	1,8	Information on page 438	1 2 3 4 5 6 7 9	■ 100

Assortment of small polishing points with soft elastomer bond mounted on shank



Ordering example: A29551301582077

Individual tools available on request.

v_{max} : 16 m/s

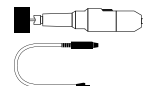

PG 4

Product number	Description	Quality	Contents	shank mm	recommended for		
A29551301582077	P7Sort. 130-15	SICGR 240	12-pieces	2,35	Information on page 438	1 2 3 4 5 6 7 9	■ 1
A29551301582071	P7Sort. 130-15	SICGR 400	12-pieces	2,35	Information on page 438	1 2 3 4 5 6 7 9	■ 1

● Inox/Steel
 ● Steel
 ● Aluminium
 ● Stone
 ● Cast material
 ● Plastic
 ● Titanium

Tungsten carbide granulate-tipped tools

164 Technical Information

165 HGW-discs

165 HGW-core drills

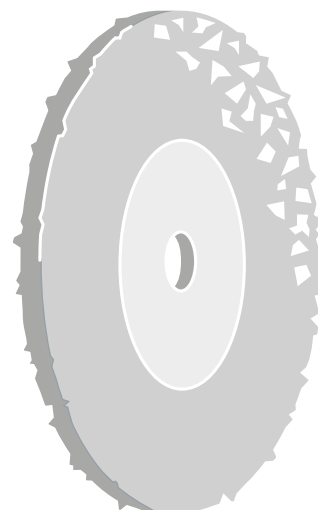

Product line marking

The product lines are illustrated by star symbols at the top of the table; please refer to page **14** and **15**.

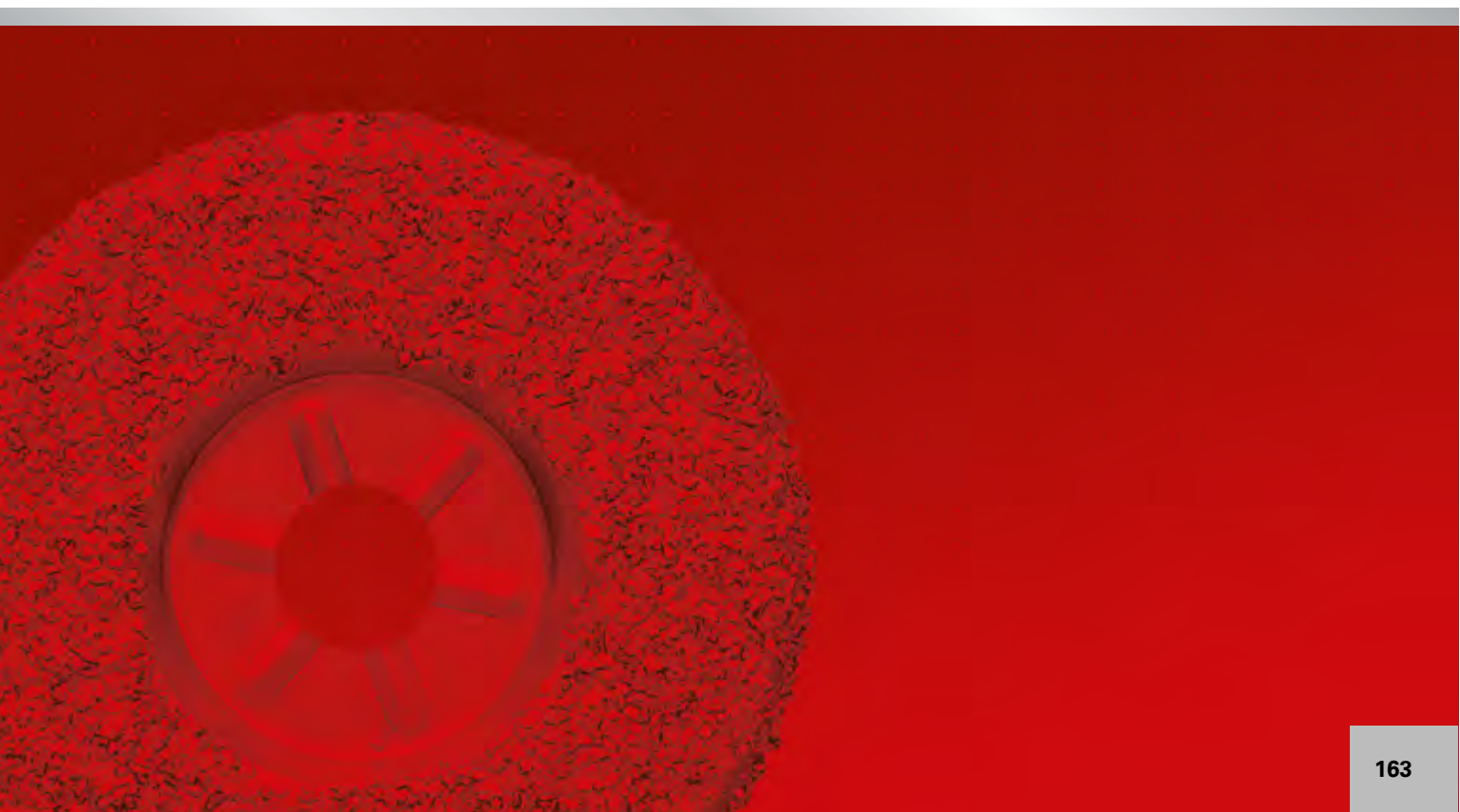

Technical Information

HGW is supplied in a wide range of grit sizes – very coarse to extra fine – and in both a dense and open structure. Please select the individual grit sizes from the table below.



Application examples

Coarse grit is used to grind soft materials; the harder the material, the finer the grit. A special manufacturing process is used to bond the grit to the core. Special coatings are available, but are dependent upon a wide variety of technical parameters. Please send your enquiry.

Safety regulations

We strongly recommend that use is made of machines with variable speeds in order to optimize cutting speeds; this will lie between 10-50 m/sec., depending on the material to be ground.



Tungsten Carbide Granulate-tipped disc, HGWT

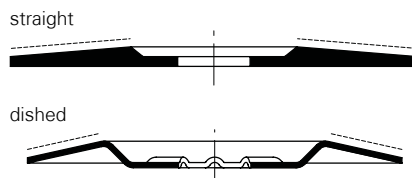

Ordering example: A18031151E

Further dimensions and grits on request

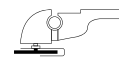

PG 3

Product number	Description	Grit	Type	Diameter mm	Bore mm	n max. (1/min)	recommended for				Information on page 438	PG 3		
A18031151E	HGWT 115 S	0,3-0,5 E	dished	115	22,2	10.500					8	9	■	1
A18031152E	HGWT 115 S	0,8-1,2 E	dished	115	22,2	10.500					8	9	■	1
A18031153E	HGWT 115 S	1,2-1,8 E	dished	115	22,2	10.500					8	9	■	1
A18031255E	HGWT 125 S	2,5-3,0 E	straight	125	22,2	9.600					8	9	■	1

Grinding, Polishing (bonded)

Core Drill-Set



Ordering example: A18300012E



PG 3

Product number	Description	Grit	Description	recommended for	Information on page 438	PG 3					
A18300012E	HGWB-Set	0,8-1,2 E	4 core drills Ø 33, 53, 63, 73 mm, including base plate, carbide center point and hexagonal shank (SW9)					8	9	■	1

Cutting and Grinding Discs

168 Technical Information

169 Structure and Components

170 Safety

171 Labelling

173 Cutting discs

185 Grinding discs

Product line marking

The product lines are illustrated by star symbols at the top of the table; please refer to page **14** and **15**.

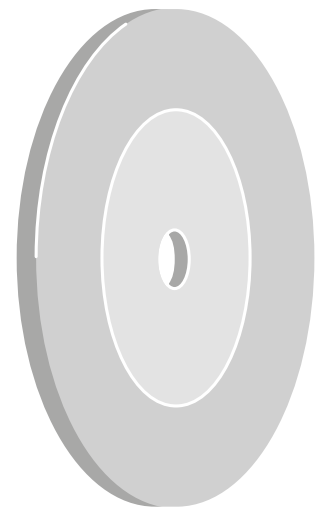

Technical Information

Durability

Resin bonded grinding and cutting wheels for free-hand application must be used within three years of manufacture. Please see metal ring for the expiry date which is specified by month and year; for instance V07/2018.



Labelling system for resin bonded grinding wheels

Example:

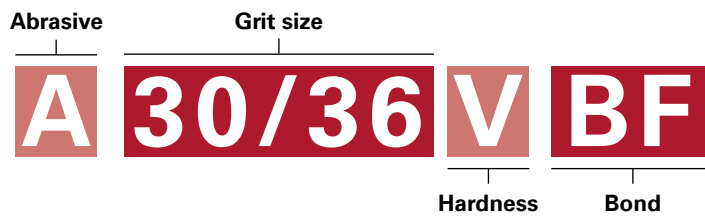

Abrasive Type	Grit			Hardness Grade			Bond
	coarse	medium	fine	soft	medium	hard	
A – aluminium oxide	12	36	60	M	R	U	BA – resin bond
C – silicon carbide	up to	up to	bis	Q	S	V	BF – resin bond, fibre-reinforced
Z – zirconia alumina	24	54	120	P	T	Z	

Working speed

LUKAS grinding discs are developed and tested for specific maximum working speeds and grinding processes.

Prior to mounting the grinding tool on the machine, it must be ensured that the machine's nominal speed (as specified on nameplate) does not exceed the maximum operating speed indicated on the grinding wheel or disc.



Maximum operating speed	Diameter of Disc [mm] /RPM [min-1]										
	50	76	100	115	125	150	180	230	300	350	400
80 m/s	30.500	20.100	15.300	13.300	12.200	10.200	8.500	6.600	5.100	4.400	3.800
100 m/s	38.200	25.100	19.100	16.650	16.600	12.700	10.600	8.300	6.400	5.400	4.700

Structure and Components

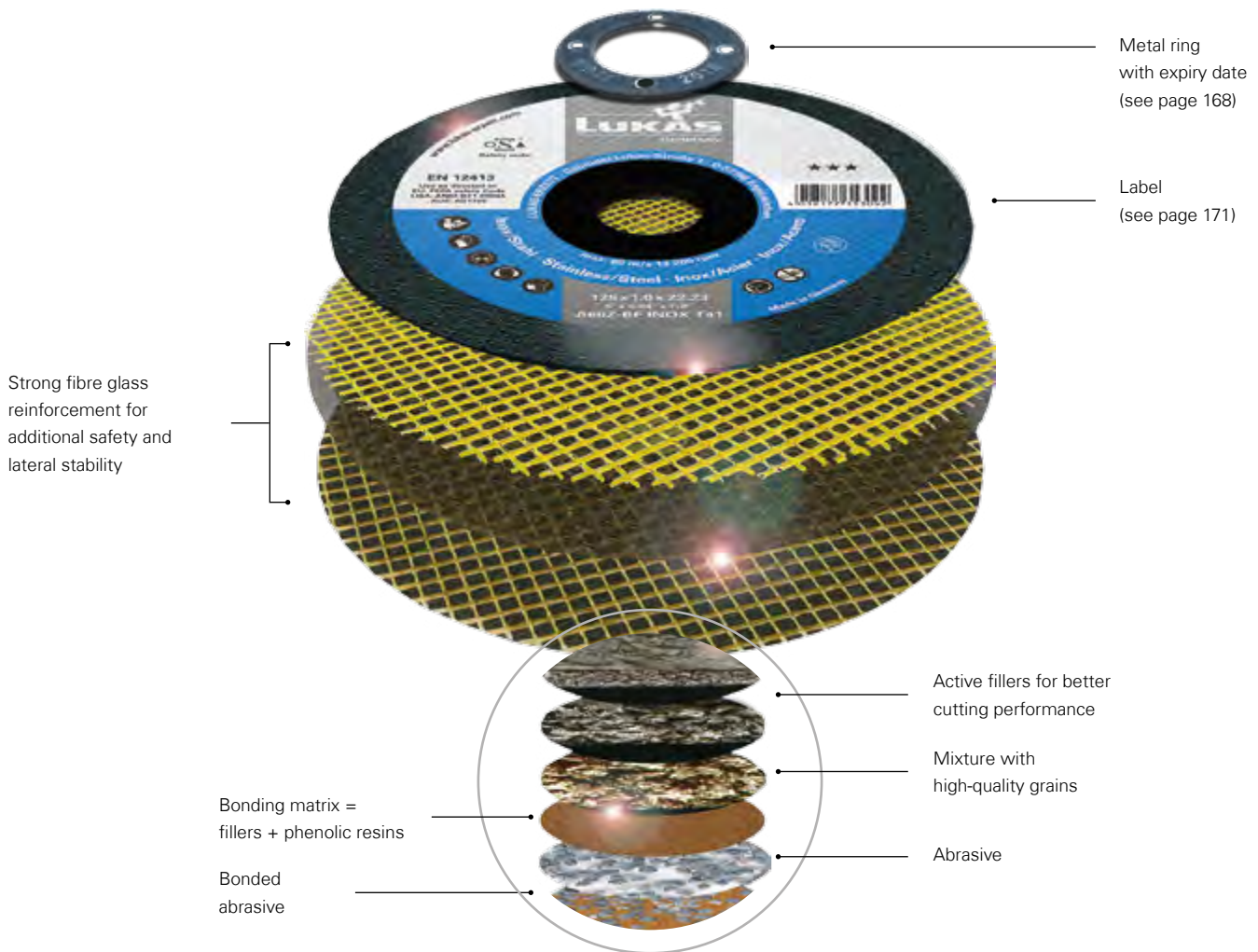

Cutting, Grinding (conventional)

Abrasive



Semi-friable aluminium oxide



Zirconia alumina



Vitrified coated roasted aluminium oxide



Ceramic grain

Safety

With regards to occupational safety and operational convenience, LUKAS responsibility to the customer is taken very seriously. Our products are designed, manufactured and produced in accordance with the most stringent quality standards to provide a maximum of customer value at minimum risk. We are a member of both, the German Abrasive Association (VDS) and the Organisation for the Safety of Abrasives (oSa) and thus actively contribute to users' health and safety.

Applied standards:

- Safety Requirements for Bonded Abrasives Products: EN12413
- Safety Requirements for Diamond Blades: EN13236

Safety recommendations

- Don't handle wheels roughly.
- Don't use non-reinforced cut-off wheels on portable machines.
- Don't store wheels in a damp atmosphere or in extreme temperatures.
- Don't mount a damaged wheel.
- Don't ever exceed the maximum operating speed marked on the wheel.
- Don't force a wheel onto a machine spindle.
- Don't use mounting flanges which are incorrect, damaged, dirty or burred.
- Don't tighten the mounting nut or locking flange excessively. To do so can distort the flanges and discs.
- Don't use a machine without a wheel guard.
- Don't use wheels without proper ventilation or dust protection equipment.
- Don't apply side pressure to cut-off wheels. You should not bend the wheel.



- Don't stop the wheel by applying pressure to the periphery or face. Always switch the machine off and allow the wheel to stop revolving.
- Don't allow the wheel to be trapped or pinched in the cut.
- Don't apply excessive pressure onto the wheel so that the driving motor slows down.
- Don't drop or lower a portable machine by the cable or airline onto the floor. A wheel can be easily cracked, if it is put down hard, by the weight of the machine. This is a common cause of wheel breakage.
- Don't grind with a depressed centre grinding wheel at an angle below 30 degrees to the work piece.
- Don't use a machine in a position where you do not have full control of the machine and you are not well balanced.

Clamping System

The use of flanges with unequal diameters is not allowed. Both flanges between which the bonded abrasive is mounted must have the same outer diameter and similar contact areas (according to EN60745-2-3:2007 and ANSI B.7.1).

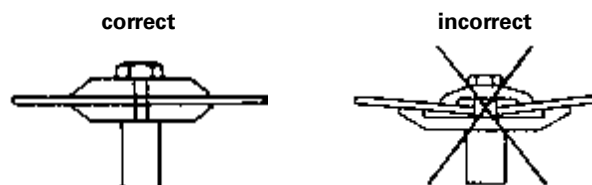

Labelling

Safety standard

Manufactured according to EN 12413

Safety recommendations

max. operating speed

A = Aluminium oxide
C = Silicon carbide
AC = Aluminium oxide / Silicon carbide
ZA = zirconia alumina / aluminium oxide

Quality
★★★ High Performance
★★☆ Industry
★☆☆ Base

EAN Code

Application

max. rpm

Application instructions

60 = Grit size
(16/very coarse, 36/medium, 60/Fine)

B = resin bond
F = fibre-reinforced

125 x 1,0 x 22,23
5'' x 0,04'' x 7/8''
A60Z-BF INOX T41

125 x 1,0 x 22,23 = D x U x H
5'' x 0,04'' x 7/8'' = D x U x H
Diameter x thickness x bore size

Cutting, Grinding (conventional)

Types of resin-bonded grinding wheels

<p>Cutting discs U = (0,8 mm–4,5 mm) (USA: Typ 1)</p> <p>T 41 Straight cutting discs</p> <ul style="list-style-type: none"> • Available in diameters from 50 (2") to 230 mm (9") for freehand applications • from 300 mm (12") to 500 mm (20") for use in stationary machines 	<p>Cutting discs U = (0,8 mm–4,5 mm) (USA: Typ 27)</p> <p>T 42 Depressed centre cutting discs</p> <ul style="list-style-type: none"> • Available in diameters from 76 (3") to 230 mm (9"), allowed for freehand use. 	<p>Grinding discs U = (3 mm–10 mm) (USA: Typ 27)</p> <p>T 27 Depressed centre grinding discs</p> <ul style="list-style-type: none"> • Available in diameters from 76 (3") to 230 mm (9"), allowed for freehand use.
---	---	--

Cutting discs

174 Qualities and areas of application

176 Free-hand cutting disc for angle grinders

183 Large cutting disc (greater than 230 mm)





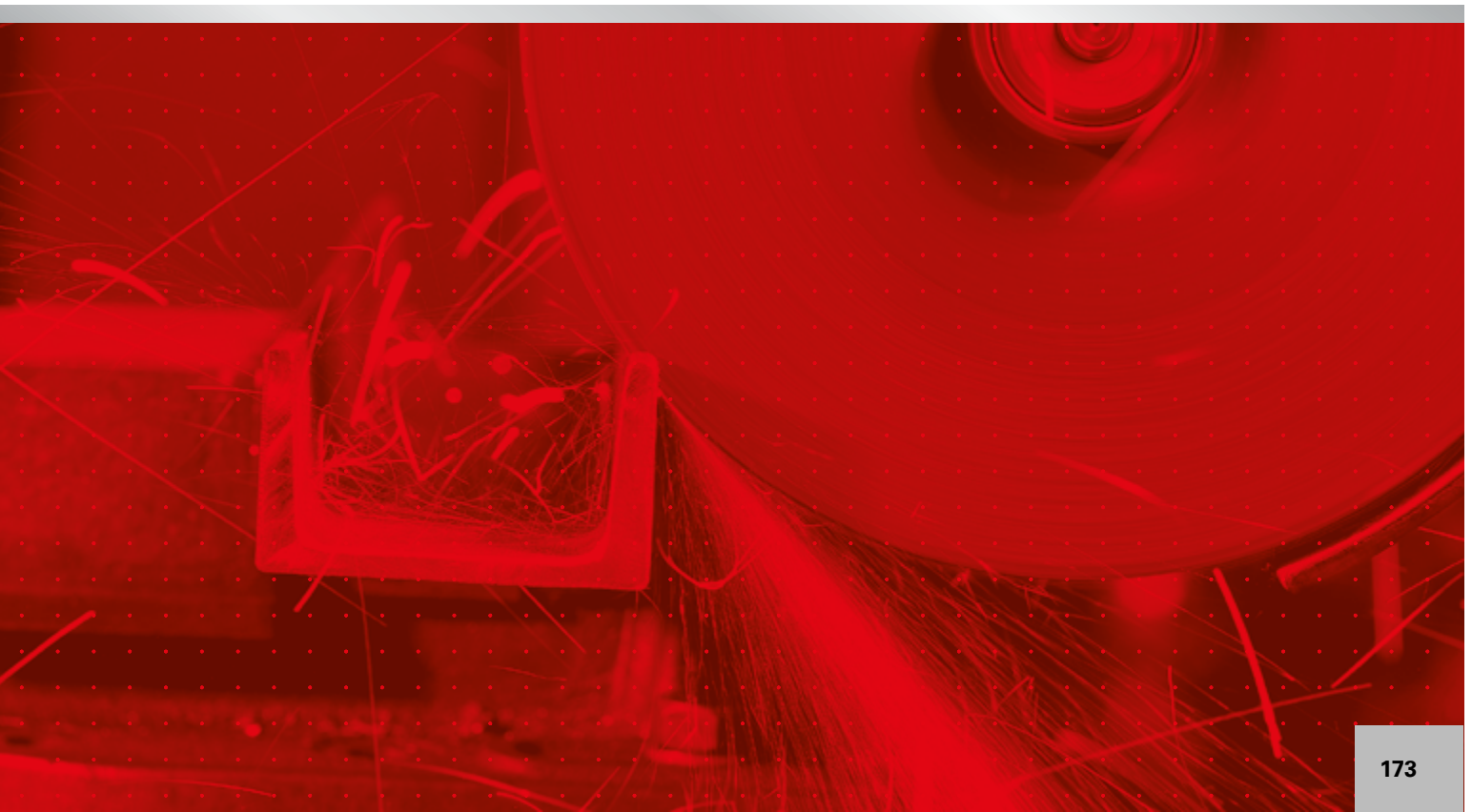
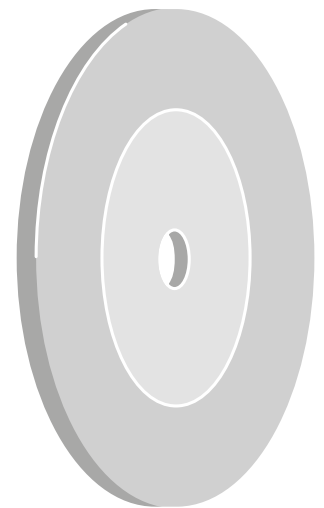

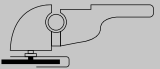

Product line marking

The product lines are illustrated by star symbols at the top of the table; please refer to page **14** and **15**.

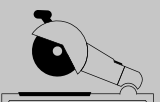
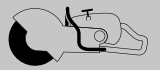

Cutting discs

Cutting, Grinding
(conventional)

Type	Product line	Material				
		Inox/Steel	Steel	Aluminium	Stone/ Cast material	Cast material
Free-hand cutting disc for angle grinders (100 mm – 230 mm) 	★★★	Page 176–177 	Page 180 			
	★★☆	Page 178 	Page 181 			
	★☆☆	Page 179–180 	Page 182–183 			
Large cutting disc (greater than 230 mm)  	★★☆					
	★☆☆	Page 183 				

PROGRESS

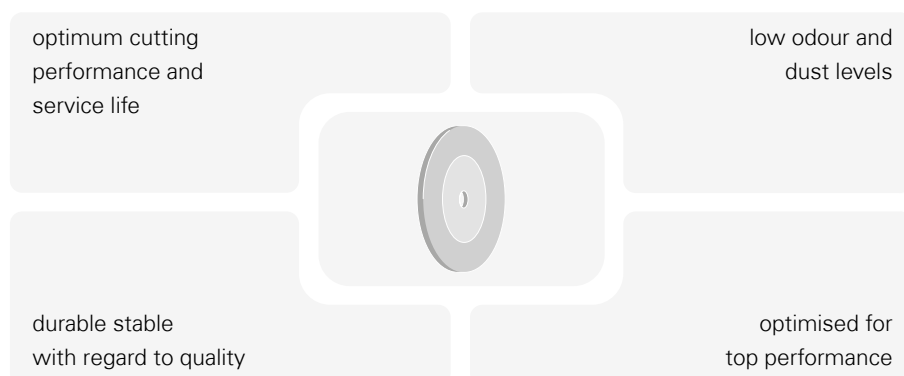

- maximum service life and cutting performance due to innovative bonding technology
- high cutting speed at low cutting temperature
- low odour and dust levels during daily usage
- ergonomic work position and maximum durability without use of excessive force
- maximum shelf life with high levels of stability with regard to quality thanks to top quality raw materials
- energy optimised for your high performance angle grinders
- environmentally friendly manufacturing process, made in Germany using up-to-date production processes and optimised formulations
- perfect for a wide variety of Inox and steel materials
- precise cutting

Cutting discs for stainless steel – PROGRESS

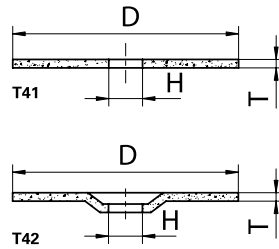

Ordering example: AT007226V9802

T41 = flat

T42 = depressed centre

Iron, sulphur and chlorine free

v_{max.}: 80 m/s

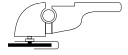

PG 7

Product number	Description	Quality	Ø D mm	T mm	H mm	n max. (1/min)	Recommended for Information on page 438		
AT007226V9802	T41 100x1,0	A60Z-BF Inox	100	1,0	16,00	15.300	① ② ③ ④ ⑤ ⑥ ⑦	■	50
AT007231V9802	T41 115x1,0	A60Z-BF Inox	115	1,0	22,23	13.300	① ② ③ ④ ⑤ ⑥ ⑦	■	50
AT007235V9802	T41 115x1,6	A46Z-BF Inox	115	1,6	22,23	13.300	① ② ③ ④ ⑤ ⑥ ⑦	■	50
AT007211V9802	T41 115x2,5	A30Z-BF Inox	115	2,5	22,23	13.300	① ② ③ ④ ⑤ ⑥ ⑦	■	25
AT007233V9802	T41 125x1,0	A60Z-BF Inox	125	1,0	22,23	12.200	① ② ③ ④ ⑤ ⑥ ⑦	■	50
AT007237V9802	T41 125x1,6	A46Z-BF Inox	125	1,6	22,23	12.200	① ② ③ ④ ⑤ ⑥ ⑦	■	50
AT007213V9802	T41 125x2,5	A30Z-BF Inox	125	2,5	22,23	12.200	① ② ③ ④ ⑤ ⑥ ⑦	■	25
AT007239V9802	T41 150x1,2	A60Z-BF Inox	150	1,2	22,23	10.200	① ② ③ ④ ⑤ ⑥ ⑦	■	50
AT007241V9802	T41 150x1,6	A46Z-BF Inox	150	1,6	22,23	10.200	① ② ③ ④ ⑤ ⑥ ⑦	■	25
AT007243V9802	T41 180x1,6	A46Z-BF Inox	180	1,6	22,23	8.500	① ② ③ ④ ⑤ ⑥ ⑦	■	25
AT007245V9802	T41 230x2,0	A46Z-BF Inox	230	2,0	22,23	6.600	① ② ③ ④ ⑤ ⑥ ⑦	■	25
AT007219V9802	T41 230x2,5	A30Z-BF Inox	230	2,5	22,23	6.600	① ② ③ ④ ⑤ ⑥ ⑦	■	25
AT005301V9802	T42 115x0,8	A60Z-BF Inox	115	0,8	22,23	13.300	① ② ③ ④ ⑤ ⑥ ⑦	■	50
AT007212V9802	T42 115x2,5	A30Z-BF Inox	115	2,5	22,23	13.300	① ② ③ ④ ⑤ ⑥ ⑦	■	25
AT005302V9802	T42 125x0,8	A60Z-BF Inox	125	0,8	22,23	12.200	① ② ③ ④ ⑤ ⑥ ⑦	■	50
AT007214V9802	T42 125x2,5	A30Z-BF Inox	125	2,5	22,23	12.200	① ② ③ ④ ⑤ ⑥ ⑦	■	25
AT007244V9802	T42 180x1,6	A46Z-BF Inox	180	1,6	22,23	8.500	① ② ③ ④ ⑤ ⑥ ⑦	■	25
AT007220V9802	T42 230x2,5	A30Z-BF Inox	230	2,5	22,23	6.600	① ② ③ ④ ⑤ ⑥ ⑦	■	25

Cutting, Grinding
(conventional)

Cutting disc set – PROGRESS

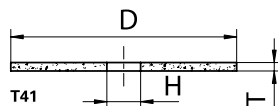

Ordering example: AT007231V9807010

T41 = flat

Iron, sulphur and chlorine free

 $v_{max.}: 80 \text{ m/s}$



PG 7

Product number	Description	Quality	Ø D mm	T mm	H mm	n max. (1/min)	Recommended for Information on page 438		
AT007231V9807010	T41 115x1,0	A60Z-BF Inox	115	1,0	22,23	13.300	① ② ③ ④ ⑤ ⑥ ⑦	■	10
AT007233V9807010	T41 125x1,0	A60Z-BF Inox	125	1,0	22,23	12.200	① ② ③ ④ ⑤ ⑥ ⑦	■	10

Handy take-away pack for construction sites

- in safety packaging
- moisture proof

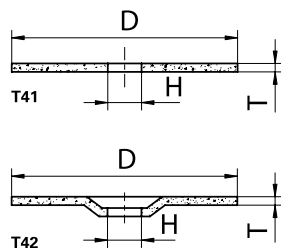
Cutting discs for stainless steel – PROMAX



Ordering example: AT001657V9802

T41 = flat

T42 = depressed centre

Iron, sulphur and chlorine free

v_{max.}: 80 m/s

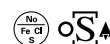
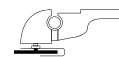

PG 7

Product number	Description	Quality	Ø D mm	T mm	H mm	n max. (1/min)	Recommended for Information on page 438		
AT005841V9802	T41 115x1,0	A60X-BF Inox	115	1,0	22,23	13.300	① ② ③ ④ ⑤ ⑥ ⑦	■	50
AT003346V9802	T41 115x1,6	A46X-BF Inox	115	1,6	22,23	13.300	① ② ③ ④ ⑤ ⑥ ⑦	■	50
AT001657V9802	T41 115x2,0	A36U-BF Inox	115	2,0	22,23	13.300	① ② ③ ④ ⑤ ⑥ ⑦	■	25
AT005842V9802	T41 125x1,0	A60X-BF Inox	125	1,0	22,23	12.200	① ② ③ ④ ⑤ ⑥ ⑦	■	50
AT003348V9802	T41 125x1,6	A46X-BF Inox	125	1,6	22,23	12.200	① ② ③ ④ ⑤ ⑥ ⑦	■	50
AT001687V9802	T41 125x2,0	A36U-BF Inox	125	2,0	22,23	12.200	① ② ③ ④ ⑤ ⑥ ⑦	■	25
AT003327V9802	T41 150x1,6	A46X-BF Inox	150	1,6	22,23	10.200	① ② ③ ④ ⑤ ⑥ ⑦	■	25
AT001743V9802	T41 180x2,0	A36U-BF Inox	180	2,0	22,23	8.500	① ② ③ ④ ⑤ ⑥ ⑦	■	25
AT005864V9802	T41 230x1,9	A46X-BF Inox	230	1,9	22,23	6.600	① ② ③ ④ ⑤ ⑥ ⑦	■	25
AT001782V9802	T41 230x2,0	A36U-BF Inox	230	2,0	22,23	6.600	① ② ③ ④ ⑤ ⑥ ⑦	■	25
AT001696V9802	T42 125x2,5	A30U-BF Inox	125	2,5	22,23	12.200	① ② ③ ④ ⑤ ⑥ ⑦	■	25
AT005571V9802	T42 180x1,6	A46X-BF Inox	180	1,6	22,23	8.500	① ② ③ ④ ⑤ ⑥ ⑦	■	25
AT005877V9802	T42 230x1,9	A46X-BF Inox	230	1,9	22,23	6.600	① ② ③ ④ ⑤ ⑥ ⑦	■	25
AT004464V9802	T42 230x3,0	A30U-BF Inox	230	3,0	22,23	6.600	① ② ③ ④ ⑤ ⑥ ⑦	■	25

Cutting disc set – PROMAX

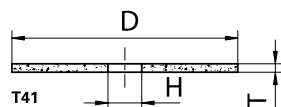

Ordering example: AT005841V9807010

T41 = flat

Iron, sulphur and chlorine free

v_{max.}: 80 m/s

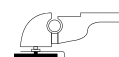

PG 7

Product number	Description	Quality	Ø D mm	T mm	H mm	n max. (1/min)	Recommended for Information on page 438		
AT005841V9807010	T41 115x1,0	A60X-BF Inox	115	1,0	22,23	13.300	① ② ③ ④ ⑤ ⑥ ⑦	■	10
AT005842V9807010	T41 125x1,0	A60X-BF Inox	125	1,0	22,23	12.200	① ② ③ ④ ⑤ ⑥ ⑦	■	10

Handy take-away pack for construction sites

- in safety packaging
- moisture proof

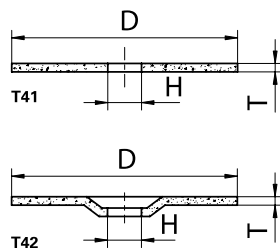
Cutting discs for stainless steel – PREMIUMFLEX

Ordering example: AT000647V9802

T41 = flat

T42 = depressed centre

Iron, sulphur and chlorine free

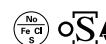
 $v_{max.}: 80 \text{ m/s}$

PG 7

Product number	Description	Quality	Ø D mm	T mm	H mm	n max. (1/min)	Recommended for Information on page 438		
AT003108V9802	T41 100x1,0	A60S-BF Inox	100	1,0	16,00	15.300	① ② ③ ④ ⑤ ⑥ ⑦	■	50
AT004643V9802	T41 115x1,0	A60S-BF Inox	115	1,0	22,23	13.300	① ② ③ ④ ⑤ ⑥ ⑦	■	50
AT000647V9802	T41 115x1,6	A46T-BF Inox	115	1,6	22,23	13.300	① ② ③ ④ ⑤ ⑥ ⑦	■	50
AT002672V9802	T41 125x1,0	A60S-BF Inox	125	1,0	22,23	12.200	① ② ③ ④ ⑤ ⑥ ⑦	■	50
AT000674V9802	T41 125x1,6	A46T-BF Inox	125	1,6	22,23	12.200	① ② ③ ④ ⑤ ⑥ ⑦	■	50
AT000700V9802	T41 150x1,6	A46T-BF Inox	150	1,6	22,23	10.200	① ② ③ ④ ⑤ ⑥ ⑦	■	25
AT000716V9802	T41 180x1,6	A46T-BF Inox	180	1,6	22,23	8.500	① ② ③ ④ ⑤ ⑥ ⑦	■	25
AT000742V9802	T41 230x1,9	A46T-BF Inox	230	1,9	22,23	6.600	① ② ③ ④ ⑤ ⑥ ⑦	■	25
AT003568V9802	T41 230x3,0	A24/30S-BF Inox	230	3,0	22,23	6.600	① ② ③ ④ ⑤ ⑥ ⑦	■	25
AT001442V9802	T42 115x2,5	A24/30S-BF Inox	115	2,5	22,23	13.300	① ② ③ ④ ⑤ ⑥ ⑦	■	25
AT004157V9802	T42 125x2,5	A24/30S-BF Inox	125	2,5	22,23	12.200	① ② ③ ④ ⑤ ⑥ ⑦	■	25
AT000718V9802	T42 180x1,6	A46T-BF Inox	180	1,6	22,23	8.500	① ② ③ ④ ⑤ ⑥ ⑦	■	25
AT000744V9802	T42 230x1,9	A46T-BF Inox	230	1,9	22,23	6.600	① ② ③ ④ ⑤ ⑥ ⑦	■	25
AT005451V9802	T42 230x2,5	A24/30S-BF Inox	230	2,5	22,23	6.600	① ② ③ ④ ⑤ ⑥ ⑦	■	25
AT004168V9802	T42 230x3,0	A24/30S-BF Inox	230	3,0	22,23	6.600	① ② ③ ④ ⑤ ⑥ ⑦	■	25

Cutting, Grinding (conventional)

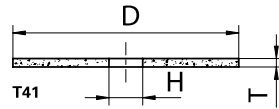
Cutting disc set – PREMIUMFLEX



Bestell-Bespiel: AT002672V9807010

T41 = flat

Iron, sulphur and chlorine free

v_{max.}: 80 m/s

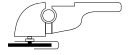

PG 7

Product number	Description	Quality	Ø D mm	T mm	H mm	n max. (1/min)	Recommended for Information on page 438		
AT004643V9807010	T41 115x1,0	A60S-BF Inox	115	1,0	22,23	13.300	① ② ③ ④ ⑤ ⑥ ⑦	■	10
AT002672V9807010	T41 125x1,0	A60S-BF Inox	125	1,0	22,23	12.200	① ② ③ ④ ⑤ ⑥ ⑦	■	10

Handy take-away pack for construction sites

- in safety packaging
- moisture proof

Cutting discs for steel – PROGRESS

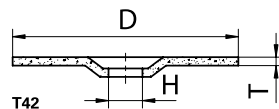
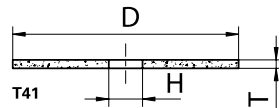

Ordering example: AT007271V9802

T41 = flat

T42 = depressed centre

v_{max.}: 80 m/s

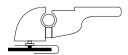

PG 7

Product number	Description	Quality	Ø D mm	T mm	H mm	n max. (1/min)	Recommended for Information on page 438		
AT007276V9802	T41 115x1,0	A60Z-BF Steel	115	1,0	22,23	13.300	① ② ③ ⑤	■	50
AT007271V9802	T41 115x1,6	A46Z-BF Steel	115	1,6	22,23	13.300	① ② ③ ⑤	■	50
AT007278V9802	T41 125x1,0	A60Z-BF Steel	125	1,0	22,23	12.200	① ② ③ ⑤	■	50
AT007273V9802	T41 125x1,6	A46Z-BF Steel	125	1,6	22,23	12.200	① ② ③ ⑤	■	50
AT007284V9802	T41 230x1,9	A46Z-BF Steel	230	1,9	22,23	6.600	① ② ③ ⑤	■	25

Cutting discs for steel – PROMAX

★★☆☆

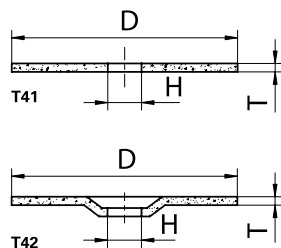

Ordering example: AT001656V9802

T41 = flat

T42 = depressed centre

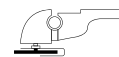
 $v_{max.}: 80 \text{ m/s}$

PG 7

Product number	Description	Quality	Ø D mm	T mm	H mm	n max. (1/min)	Recommended for Information on page 438					PG 7		
AT005840V9802	T41 115x1,0	A60X-BF Steel	115	1,0	22,23	13.300	1	2	3	5			■	50
AT013301V9802	T41 115x1,6	A46X-BF Steel	115	1,6	22,23	13.300	1	2	3	5			■	50
AT001656V9802	T41 115x2,0	A36U-BF Steel	115	2,0	22,23	13.300	1	2	3	5			■	25
AT005835V9802	T41 125x1,0	A60X-BF Steel	125	1,0	22,23	12.200	1	2	3	5			■	50
AT013302V9802	T41 125x1,6	A46X-BF Steel	125	1,6	22,23	12.200	1	2	3	5			■	50
AT001686V9802	T41 125x2,0	A36U-BF Steel	125	2,0	22,23	12.200	1	2	3	5			■	25
AT011086V9802	T41 125x2,5	A30X-BF Steel	125	2,5	22,23	12.200	1	2	3	5			■	25
AT013303V9802	T41 150x1,6	A46X-BF Steel	150	1,6	22,23	10.200	1	2	3	5			■	25
AT013305V9802	T41 180x1,6	A46X-BF Steel	180	1,6	22,23	8.500	1	2	3	5			■	25
AT001742V9802	T41 180x2,0	A36U-BF Steel	180	2,0	22,23	8.500	1	2	3	5			■	25
AT005867V9802	T41 230x1,9	A46X-BF Steel	230	1,9	22,23	6.600	1	2	3	5			■	25
AT001781V9802	T41 230x2,0	A36U-BF Steel	230	2,0	22,23	6.600	1	2	3	5			■	25
AT001785V9802	T41 230x3,0	A30U-BF Steel	230	3,0	22,23	6.600	1	2	3	5			■	25
AT001665V9802	T42 115x2,5	A30U-BF Steel	115	2,5	22,23	13.300	1	2	3	5			■	25
AT001695V9802	T42 125x2,5	A30U-BF Steel	125	2,5	22,23	12.200	1	2	3	5			■	25
AT001724V9802	T42 150x2,5	A30U-BF Steel	150	2,5	22,23	10.200	1	2	3	5			■	25
AT001750V9802	T42 180x3,0	A30U-BF Steel	180	3,0	22,23	8.500	1	2	3	5			■	25
AT001790V9802	T42 230x2,5	A30U-BF Steel	230	2,5	22,23	6.600	1	2	3	5			■	25

 Cutting, Grinding
(conventional)

Cutting discs for steel – PREMIUMFLEX

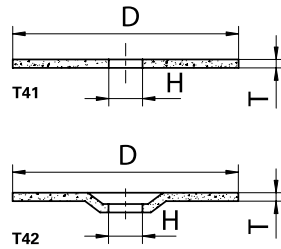
★☆☆



Ordering example: AT000638V9802

T41 = flat

T42 = depressed centre

v_{max.}: 80 m/s

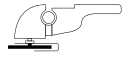

PG 7

Product number	Description	Quality	Ø D mm	T mm	H mm	n max. (1/min)	Recommended for Information on page 438							
AT006440V9802	T41 115x1,0	A60S-BF Steel	115	1,0	22,23	13.300	1	2	3	5			■	50
AT000648V9802	T41 115x1,6	A46T-BF Steel	115	1,6	22,23	13.300	1	2	3	5			■	50
AT000656V9802	T41 115x2,5	A24R-BF Steel	115	2,5	22,23	13.300	1	2	3	5			■	25
AT006710V9802	T41 125x1,0	A60S-BF Steel	125	1,0	22,23	12.200	1	2	3	5			■	50
AT000675V9802	T41 125x1,6	A46T-BF Steel	125	1,6	22,23	12.200	1	2	3	5			■	50
AT000679V9802	T41 125x2,5	A24R-BF Steel	125	2,5	22,23	12.200	1	2	3	5			■	25
AT000707V9802	T41 150x2,5	A24R-BF Steel	150	2,5	22,23	10.200	1	2	3	5			■	25
AT000717V9802	T41 180x1,6	A46T-BF Steel	180	1,6	22,23	8.500	1	2	3	5			■	25
AT000728V9802	T41 180x3,0	A24R-BF Steel	180	3,0	22,23	8.500	1	2	3	5			■	25
AT000743V9802	T41 230x1,9	A46T-BF Steel	230	1,9	22,23	6.600	1	2	3	5			■	25
AT000967V9802	T41 230x2,0	A36T-BF Steel	230	2,0	22,23	6.600	1	2	3	5			■	25
AT000750V9802	T41 230x3,0	A24R-BF Steel	230	3,0	22,23	6.600	1	2	3	5			■	25
AT000638V9802	T42 100x2,5	A24R-BF Steel	100	2,5	16	15.300	1	2	3	5			■	25
AT000662V9802	T42 115x2,5	A24R-BF Steel	115	2,5	22,23	13.300	1	2	3	5			■	25
AT000688V9802	T42 125x2,5	A24R-BF Steel	125	2,5	22,23	15300	1	2	3	5			■	25
AT000732V9802	T42 180x3,0	A24R-BF Steel	180	3,0	22,23	8.500	1	2	3	5			■	25
AT000745V9802	T42 230x1,9	A46T-BF Steel	230	1,9	22,23	6.600	1	2	3	5			■	25
AT000754V9802	T42 230x3,0	A24R-BF Steel	230	3,0	22,23	6.600	1	2	3	5			■	25

Cutting, Grinding
(conventional)

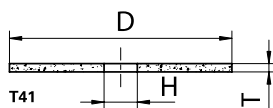
Stationary cutting discs for stainless steel – PREMIUMFLEX

Ordering example: AT010003

T41 = flat

Iron, sulphur and chlorine free

 $v_{max.}: 80 \text{ m/s}$

PG 7

Product number	Description	Quality	Ø D mm	T mm	H mm	n max. (1/min)	Recommended for Information on page 438		
AT010003	T41 300x3,5	A30S-BF Inox	300	3,5	32,00	5.100	1 2 3 4 5 6 7	■	10
AT020208	T41 350x2,6	A30S-BF Inox	350	2,6	25,40	4.400	1 2 3 4 5 6 7	■	10

Cutting, Grinding (conventional)

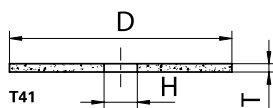
Cutting discs for steel – PREMIUMFLEX

Ordering example: AT010052

T41 = flat

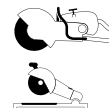
 $v_{max.}: 100 \text{ m/s}$

PG 7

Product number	Description	Quality	Ø D mm	T mm	H mm	n max. (1/min)	Recommended for Information on page 438		
AT010052	T41 300x4,0	A24R-BF	300	4,0	20,00	6.400	1 2 3 5	■	10
AT010055	T41 350x4,0	A24R-BF	350	4,0	20,00	5.400	1 2 3 5	■	10
AT010057	T41 350x4,0	A24R-BF	350	4,0	25,40	5.400	1 2 3 5	■	10

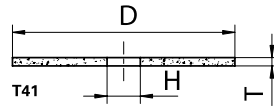
Stationary cutting discs for steel – PREMIUMFLEX



Ordering example: AT001774

T41 = flat

v_{max.}: 80 m/s bzw. 100 m/s



PG 7

Product number	Description	Quality	Ø D mm	T mm	H mm	n max. (1/min)	Recommended for Information on page 438							
AT010028	T41 300x2,6	A36S-BF Steel	300	2,6	25,40	6.400 / 80 m/s	① ② ③ ⑤						■	10
AT001774	T41 300x3,5	A30T-BF Steel	300	3,5	22,23	6.400 / 100 m/s	① ② ③ ⑤						■	10
AT001776	T41 300x3,5	A30T-BF Steel	300	3,5	25,40	6.400 / 100 m/s	① ② ③ ⑤						■	10
AT010020	T41 300x3,5	A30T-BF Steel	300	3,5	32,00	6.400 / 100 m/s	① ② ③ ⑤						■	10
AT010029	T41 350x2,6	A36S-BF Steel	350	2,6	25,40	5.400 / 80 m/s	① ② ③ ⑤						■	10
AT010022	T41 350x3,5	A30T-BF Steel	350	3,5	25,40	5.400 / 100 m/s	① ② ③ ⑤						■	10
AT010023	T41 350x3,5	A30T-BF Steel	350	3,5	32,00	5.400 / 100 m/s	① ② ③ ⑤						■	10
AT010030	T41 400x3,2	A36S-BF Steel	400	3,2	25,40	4.700 / 80 m/s	① ② ③ ⑤						■	5
AT010026	T41 400x4,0	A30T-BF Steel	400	4,0	32,00	4.700 / 100 m/s	① ② ③ ⑤						■	5

Cutting, Grinding
(conventional)

Grinding discs

186 Qualities and areas of application

188 Free-hand grinding discs for angle grinders

Product line marking

The product lines are illustrated by star symbols at the top of the table; please refer to page **14** and **15**.

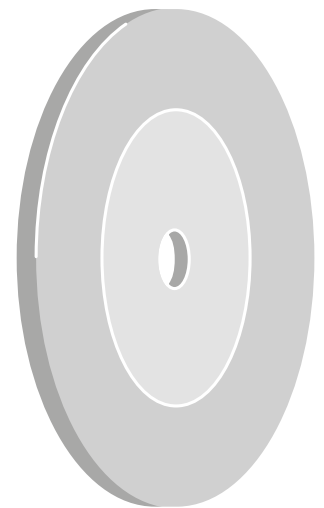

Cutting, Grinding
(conventional)

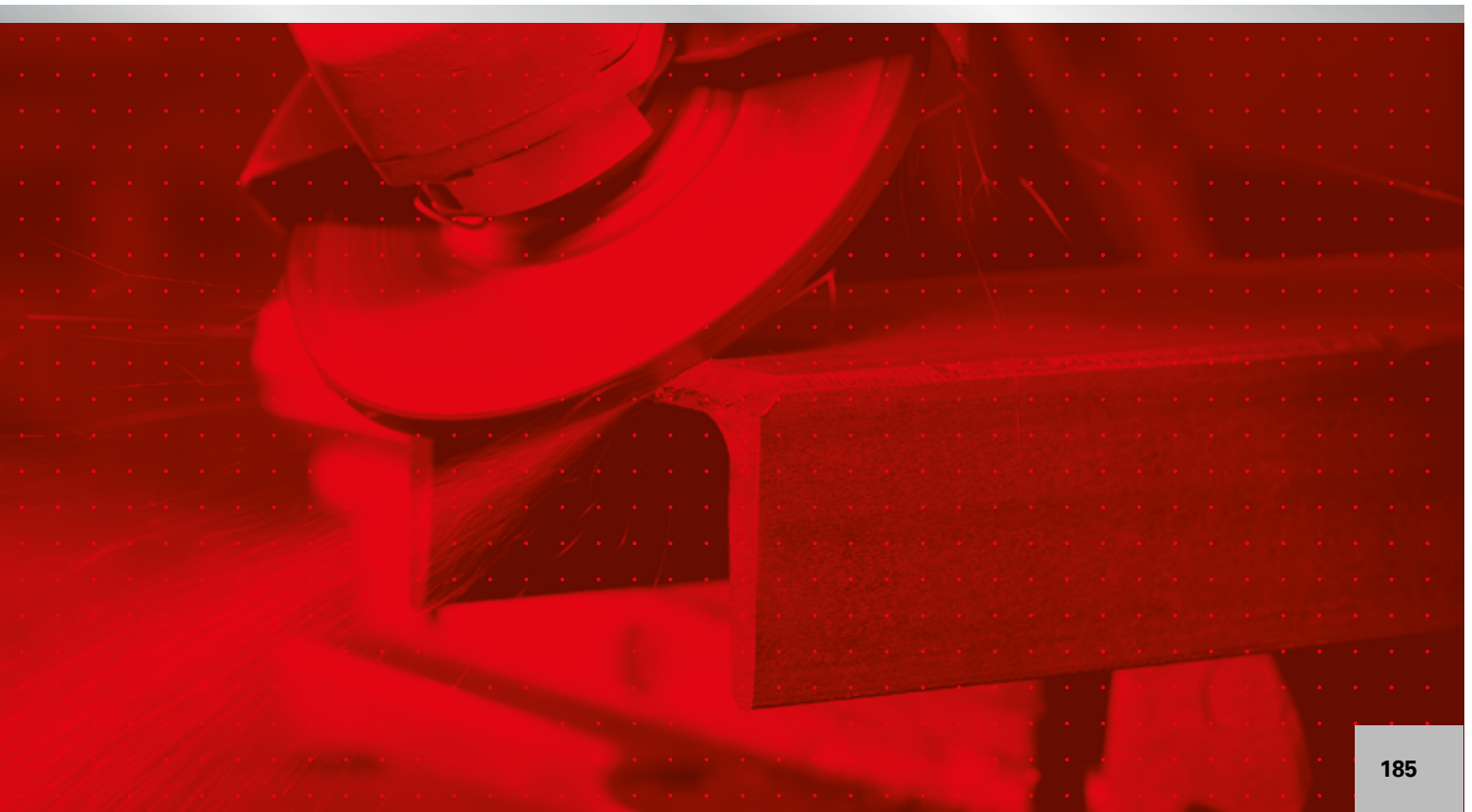

Grinding discs

Type	Product line	Material					
		INOX/Steel	Steel	Aluminium	Stone/ Cast material	Cast material	
Free-hand grinding discs for angle grinders 	★★★	Page 188 	Page 190 				
	★★☆	Page 189 	Page 190 		Page 192 	Page 191 	
	★☆☆	Page 189 	Page 191 		Page 193 	Page 192 	

Cutting, Grinding
(conventional)

PROGRESS

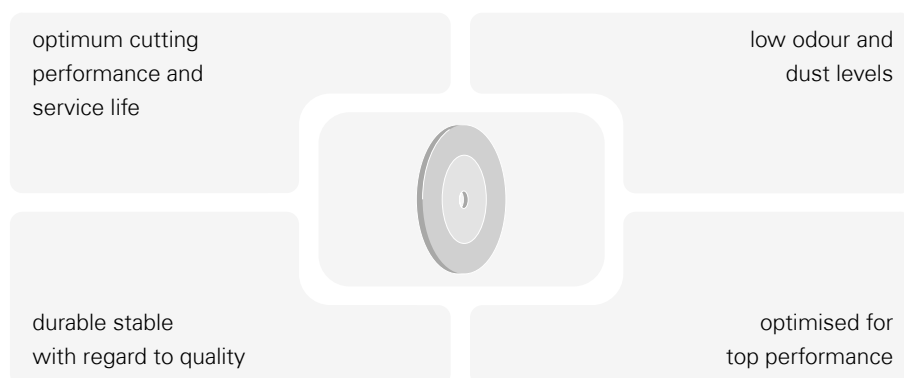

- maximum service life and cutting performance due to innovative bonding technology
- high cutting speed at low cutting temperature
- low odour and dust levels during daily usage
- ergonomic work position and maximum durability without use of excessive force
- maximum shelf life with high levels of stability with regard to quality thanks to top quality raw materials
- energy optimised for your high performance angle grinders
- environmentally friendly manufacturing process, made in Germany using up-to-date production processes and optimised formulations
- perfect for a wide variety of inox and steel materials
- precise cutting



Cutting and grinding
without tool change.
Safe. Precise. Perfect.

**Grinding and cutting discs to machine stainless steel –
PROGRESS COOL JOBBER**

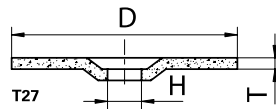

Ordering example: AS015675V9802

T27 = depressed centre

Iron, sulphur and chlorine free

$v_{max.}$: 80 m/s

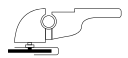

PG 7

Product number	Description	Quality	Ø D mm	T mm	H mm	n max. (1/min)	Recommended for Information on page 438		
AS015675V9802	T27 115x2,0	A36V-BF Inox COOL JOBBER	115	2,0	22,23	13.300	1 2 3 4 6	■	25
AS015676V9802	T27 125x2,0	A36V-BF Inox COOL JOBBER	125	2,0	22,23	12.200	1 2 3 4 6	■	25

Grinding discs to machine stainless steel – PROGRESS

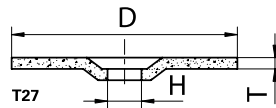

Ordering example: AS013491V9802

T27 = depressed centre

Iron, sulphur and chlorine free

$v_{max.}$: 80 m/s

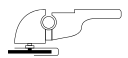

PG 7

Product number	Description	Quality	Ø D mm	T mm	H mm	n max. (1/min)	Recommended for Information on page 438		
AS013491V9802	T27 115x7,0	A24U-BF Inox	115	7,0	22,23	13.300	1 2 3 4 6	■	10
AS013492V9802	T27 125x7,0	A24U-BF Inox	125	7,0	22,23	12.200	1 2 3 4 6	■	10
AS013496V9802	T27 230x7,0	A24U-BF Inox	230	7,0	22,23	6.600	1 2 3 4 6	■	10

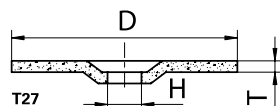
Grinding discs for stainless steel – PROMAX

Ordering example: AS003100V9802

T27 = depressed centre

Iron, sulphur and chlorine free

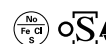
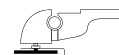
 $v_{max.}: 80 \text{ m/s}$

PG 7

Product number	Description	Quality	Ø D mm	T mm	H mm	n max. (1/min)	Recommended for Information on page 438		
AS003100V9802	T27 115x6,0	A24X-BF Inox	115	6,0	22,23	13.300	1 2 3 4 6	■	10
AS003101V9802	T27 125x6,0	A24X-BF Inox	125	6,0	22,23	12.200	1 2 3 4 6	■	10
AS003103V9802	T27 180x6,0	A24X-BF Inox	180	6,0	22,23	8.500	1 2 3 4 6	■	10
AS003104V9802	T27 230x6,0	A24X-BF Inox	230	6,0	22,23	6.600	1 2 3 4 6	■	10

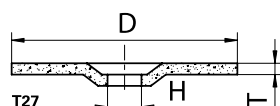
Cutting, Grinding (conventional)

Grinding discs for stainless steel – PREMIUMFLEX

Ordering example: AS000105V9802

T27 = depressed centre

Iron, sulphur and chlorine free

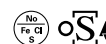
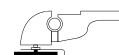
 $v_{max.}: 80 \text{ m/s}$

PG 7

Product number	Description	Quality	Ø D mm	T mm	H mm	n max. (1/min)	Recommended for Information on page 438		
AS002037V9802	T27 100x6,0	A24/30S-BF Inox	100	6,0	16,00	15.300	1 2 3 4	■	10
AS000105V9802	T27 115x6,0	A24/30S-BF Inox	115	6,0	22,23	13.300	1 2 3 4	■	10
AS000106V9802	T27 125x6,0	A24/30S-BF Inox	125	6,0	22,23	12.200	1 2 3 4	■	10
AS000107V9802	T27 150x6,0	A24/30S-BF Inox	150	6,0	22,23	10.200	1 2 3 4	■	10
AS000108V9802	T27 180x6,0	A24/30S-BF Inox	180	6,0	22,23	8.500	1 2 3 4	■	10
AS000109V9802	T27 230x6,0	A24/30S-BF Inox	230	6,0	22,23	6.600	1 2 3 4	■	10

Grinding discs for steel – PROGRESS

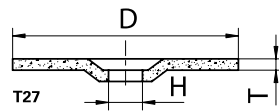
★★★



Ordering example: AS012451V9802

T27 = depressed centre

v_{max.}: 80 m/s

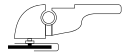

PG 7

Product number	Description	Quality	Ø D mm	T mm	H mm	n max. (1/min)	Recommended for Information on page 438		
AS012451V9802	T27 115x7,0	A24X-BF Steel	115	7,0	22,23	13.300	① ② ③	■	10
AS012453V9802	T27 125x7,0	A24X-BF Steel	125	7,0	22,23	12.200	① ② ③	■	10
AS012458V9802	T27 150x7,0	A24X-BF Steel	150	7,0	22,23	10.200	① ② ③	■	10
AS012466V9802	T27 180x7,0	A24X-BF Steel	180	7,0	22,23	8.500	① ② ③	■	10
AS012468V9802	T27 230x7,0	A24X-BF Steel	230	7,0	22,23	6.600	① ② ③	■	10

Grinding discs for steel – PROMAX

★★☆

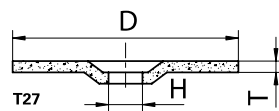

Ordering example: AS001679V9802

T27 = depressed centre

v_{max.}: 80 m/s



PG 7

Product number	Description	Quality	Ø D mm	T mm	H mm	n max. (1/min)	Recommended for Information on page 438		
AS001679V9802	T27 115x6,0	A24/30T-BF Steel	115	6,0	22,23	13.300	① ② ③ ⑤	■	10
AS001710V9802	T27 125x6,0	A24/30T-BF Steel	125	6,0	22,23	12.200	① ② ③ ⑤	■	10
AS001811V9802	T27 230x6,0	A24/30T-BF Steel	230	6,0	22,23	6.600	① ② ③ ⑤	■	10

Grinding discs for steel – PREMIUMFLEX

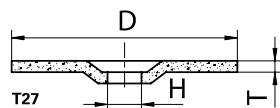

Ordering example: AS000667V9802

T27 = depressed centre

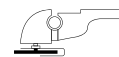
 $v_{max.}: 80 \text{ m/s}$

PG 7

Product number	Description	Quality	Ø D mm	T mm	H mm	n max. (1/min)	Recommended for Information on page 438		
AS000667V9802	T27 115x6,0	A24/30S-BF Steel	115	6,0	22,23	13.300	1 2 3		■ 10
AS000690V9802	T27 125x4,0	A24/30S-BF Steel	125	4,0	22,23	12.200	1 2 3		■ 10
AS000692V9802	T27 125x6,0	A24/30S-BF Steel	125	6,0	22,23	12.200	1 2 3		■ 10
AS000712V9802	T27 150x6,0	A24/30S-BF Steel	150	6,0	22,23	10.200	1 2 3		■ 10
AS000737V9802	T27 180x7,0	A24/30S-BF Steel	180	7,0	22,23	8.500	1 2 3		■ 10
AS000762V9802	T27 230x6,0	A24/30S-BF Steel	230	6,0	22,23	6.600	1 2 3		■ 10

Cutting, Grinding (conventional)

Grinding discs for cast iron – PROMAX

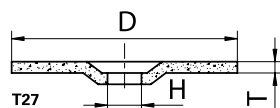

Ordering example: AS001711V9802

T27 = depressed centre

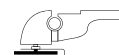
 $v_{max.}: 80 \text{ m/s}$

PG 7

Product number	Description	Quality	Ø D mm	T mm	H mm	n max. (1/min)	Recommended for Information on page 438		
AS001711V9802	T27 125x6,0	ZA24R-BF Cast	125	6,0	22,23	12.200	1 2 3 5		■ 10
AS001773V9802	T27 180x6,0	ZA24R-BF Cast	180	6,0	22,23	8.500	1 2 3 5		■ 10
AS001812V980201	T27 230x6,0	ZA24R-BF Cast	230	6,0	22,23	6.600	1 2 3 5		■ 10

Grinding discs for cast iron – PREMIUMFLEX

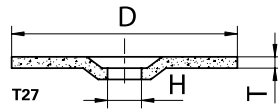

Ordering example: AS000867V9802

T27 = depressed centre

v_{max.}: 80 m/s

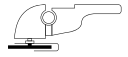

PG 7

Product number	Description	Quality	Ø D mm	T mm	H mm	n max. (1/min)	Recommended for Information on page 438		
AS000867V9802	T27 180x8,0	AC24P-BF Cast	180	8,0	22,23	8.500	5		10

Cutting, Grinding
(conventional)

Grinding discs for stone and cast iron – Promax

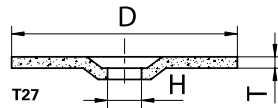

Ordering example: AS000320V9802

T27 = depressed centre

v_{max.}: 80 m/s

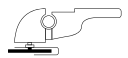

PG 7

Product number	Description	Quality	Ø D mm	T mm	H mm	n max. (1/min)	Recommended for Information on page 438		
AS000320V9802	T27 180x6,0	C24R-BF Stone	180	6,0	22,23	8.500	5 7		10

Grinding discs for stone and cast iron – PREMIUMFLEX

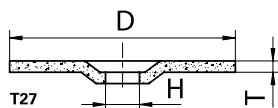

Ordering example: AS001600V9802

T27 = flat

v_{max.}: 80 m/s

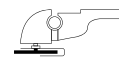

PG 7

Product number	Description	Quality	Ø D mm	T mm	H mm	n max. (1/min)	Recommended for Information on page 438		
AS001600V9802	T27 230x6,0	AC24S-BF Stone	230	6,0	22,23	6.600	5 10 11 12	■	10

Cutting, Grinding (conventional)

Flexible Grinding and Polishing Tools

196 General Information/Qualities

199 Lamellar Flap Discs

235 Flap wheel consisting of an abrasive fleece

251 Flap wheel consisting of an abrasive fleece and abrasive cloth combination

259 Flap wheels

269 Flap rolls

277 Abrasive Bands and Mandrels

291 Abrasive Rolls and Mandrels

297 Abrasive Caps and Abrasive Sleeves

309 Abrasive Discs and Mandrels

329 Fibre discs, backing plates, economy rolls, abrasive sheets and fleece rolls

Product line marking



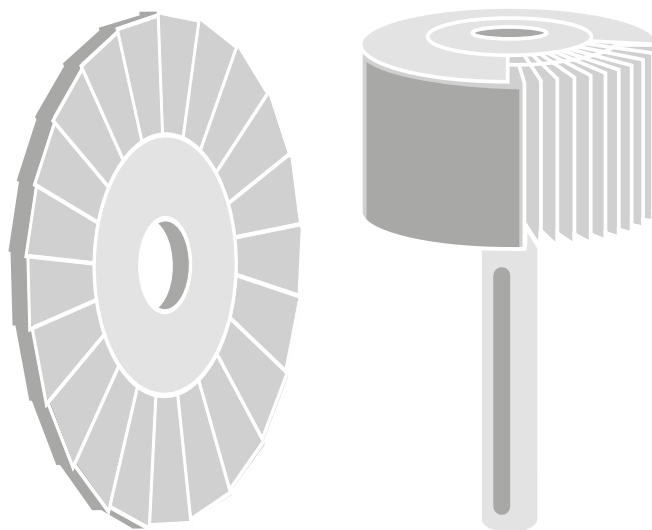



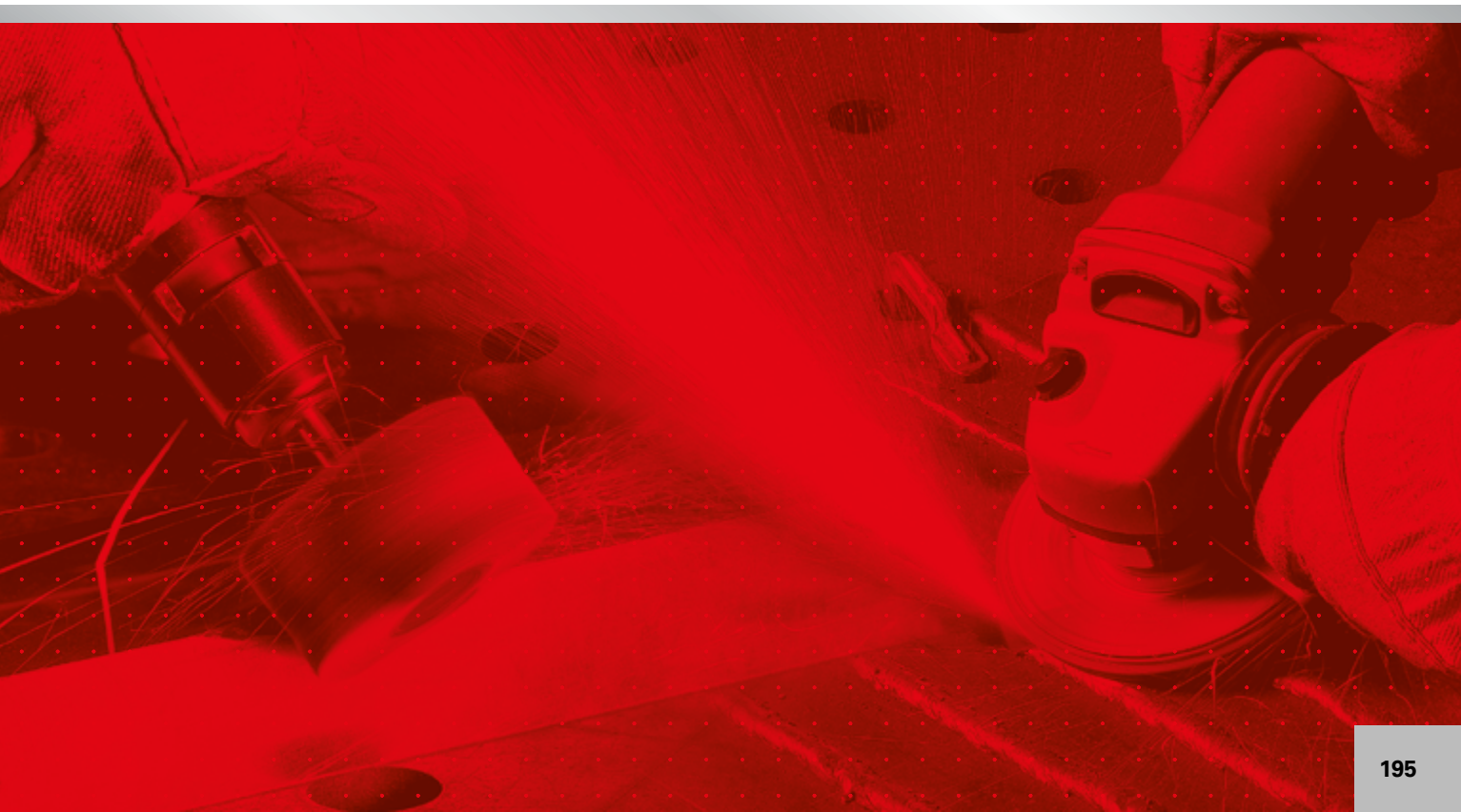

The product lines are illustrated by star symbols at the top of the table; please refer to page **14** and **15**.

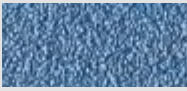

Grinding, Polishing
(flexible)









Qualities and Applications

Quality		Characteristics	Applications/Grinding	Available as	Page
 NK	Abrasive cloth reg. Aluminium Oxide	tough grain	Forged steel, malleable iron, grey cast iron, carbon steel, deep-drawn steels, steel band, zinc die castings, nonferrous metals, wood	mounted flap wheels flap wheels flap rolls flap rolls bands abrasive rolls caps abrasive sleeves discs fibre discs Economy rolls sheets of abrasive cloth	221–223 225 236 238–239 261–262 271 282–284 286–289 293–295 299–308 307 314 322–324 332–334 337 338
 NKE	Abrasive cloth using reg. Aluminium Oxide with special coating containing active grinding additives	tough grain	Chrome-nickel and other alloyed steels, deep drawn steels, titanium and titanium alloyed steels, heat resistant steels	mounted flap wheels discs	247 315
 ZK	Abrasive cloth with Zirconia Alum. Oxide	very tough and resilient grain	Forged steels, metals difficult to machine and with extreme hard surfaces i.e. welds, titanium and titanium alloys, heat resistant steels	Lamellar Flap Discs abrasive belts discs fibre discs	207, 211, 215, 218–227, 320 281, 289 313, 319 332
 Z POWER	Abrasive cloth using Zirconia Alum. Oxide with special coating containing active grinding additives	optimum stock removal rate, excellent tool life	all alloyed steels	Lamellar Flap Discs abrasive bands abrasive discs	206, 210 280 312–313
 ZKS	Abrasive cloth using Zirconia Alum. Oxide with special coating containing active grinding additives	M-Bonding with polyester fibre excellent stock removal rate with very good tool life	Forged steels, metals difficult to machine and with extreme hard surfaces i.e. welds, titanium and titanium alloys, heat resistant steels	Lamellar Flap Discs	211 218–220 227
 NKS	Abrasive cloth using reg. Aluminium Oxide with special coating containing active grinding additives	optimum stock removal rate, excellent tool life	corrosion and heat resistant steel	abrasive caps	299 301 303 305
 SIC	Abrasive cloth with Silicon carbide	cool cutting; special quality for the aircraft industry	Aluminium and aluminium alloys, brittle material, glass ceramics, titanium and titanium alloys, heat resistant steels, plastics	flap discs mounted flap wheels discs	211 248 315–316 322
 CERAMIC	Abrasive cloth ceramic grain	optimum stock removal rate without shredding of grain. Very stable due to reinforced backing, cool cutting.	stainless steel, nickel alloys	Lamellar Flap Discs mounted flap wheels abrasive belts discs fibre discs	206, 210, 217, 220 237 279 312 331

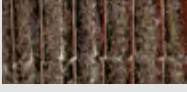
Grinding, Polishing (flexible)

Qualities and Applications

Quality		Characteristics	Applications/Grinding	Available as	Page
 PG	reinforced ceramic-grain abrasive cloth	maximum removal rate and service life thanks to self-sharpening ceramic grain	Steel, stainless steel, hardened/coated surfaces	Compact grinding discs	202 212
 A	Abrasive fleece reg. Aluminium Oxide	polishing effect through fibre structure, consistent results due to continuous exposure of new grit particles	Chrome-nickel alloys and other stainless steels, zinc die castings, non-ferrous metals, wood	mounted flap wheels flap wheels fleece mops flap rolls fleece pads/ fleece rolls	253–254 263–265 267 272, 274 339
 C	Abrasive fleece silicon carbide	polishing effect through fibre structure, consistent results due to continuous exposure of new grit particles	Titanium and titanium alloys, silver and silverplated, aluminium and aluminium alloys, plastics	mounted flap wheels flap wheels flap rolls Semi-flexible grinding disc fleece pads/ fleece rolls	255 263–265 274 335 339
 TF	Abrasive fleece/cloth reg. Aluminium Oxide reinforced fleece Abrasive fleece	Abrasive cloth lamellars and abrasive fleece lamellars of our combined mounted flap wheels wear off more equal. Higher stock removal efficiency.	Ideal for surface finishing of metalsheet components such as stainless steel sinks and containers	mounted flap wheels flap rolls	256 269
 A	Abrasive fleece/ abrasive cloth combined Al.-Oxide	intensified grinding action through combination of fleece and abrasive cloth	Chrome-nickel alloys and other stainless steels, zinc die castings, non-ferrous metals, wood	Lamellar Flap Discs mounted flap wheels flap wheels flap rolls	228 257 266 273–274
 C	Abrasive fleece/ abrasive cloth combined Sil.-Carbide	intensified grinding action through combination of fleece and abrasive cloth	Titanium and titanium alloys, silver and silverplated, aluminium and aluminium alloys, plastics	Lamellar Flap Discs mounted flap wheels flap wheels	228 258 266
 AS	Polyamid-Fleece	impregnated with aggressive abrasive grit	removal of paint and adhesives, cement and concrete residues, derusting, restoring and polishing of a wide variety of surfaces.	AS-Tools	367
 Z	Abrasive fleece zirconia aluminium oxide	Polishing effect through fibre structure, more aggressive	Cr-Ni and other stainless steels, zinc injection mouldings, non-ferrous metals	mounted flap wheels	253

Information

General

Our flexible grinding and polishing tools are manufactured from high quality abrasive cloth and abrasive fleece. They consist of a flexible backing coated with abrasive grain (please refer to page 196 and 197).

Backings used: Toile, polyester, scotch-brite, fibre

Grain types used: aluminium oxide (NK), silicon carbide (SIC), zirconia aluminium oxide (ZK), ceramic (ceramic)

Our flexible grinding and polishing tools are available in several different shapes and dimensions; they cover a wide spectrum of application i.e. from high stock removal to achieving an extremely fine surface finish.

Operating recommendation

An increase in speed makes the abrasive grit act finer; a reduction in speed makes the abrasive grit act coarser. Do not apply high pressure. Performance will not increase and tool life will be reduced. If stock removal is insufficient select a coarser grit size, do not increase pressure. The use of grinding additives can improve the efficiency.

Safety instructions

Please note our recommended operating speeds. When using and storing flexible grinding and polishing tools, please take note of the safety regulations and regulations for prevention of accidents, including the FEPA-safety recommendations. The tools are marked with pictograms according to FEPA recommendations for the use of coated abrasives.

Lamellar Flap Discs

196 Quality and Applications

200 General Information

202 Purple Grain – iQ-Series

204 SLTT – iQ-Series

208 V2 Power – iQ-Series

212 V4 Purple Power – iQ-Series

214 V4 Master – iQ-Series

216 SLTflex – iQ-Series

218 SLTsflex – iQ-Series

220 SLTR Control

220 SLTZ

221 SLTO/SLTR – Ceramic

221 SLTO/SLTR

225 SLTB

226 SLTK

227 SLTC, NAWAROFLEX®

228 SLTM, NAWAROFLEX®

228 SLTV, NAWAROFLEX®

229 SLTP

229 P6PT

232 SLTG

233 GTR

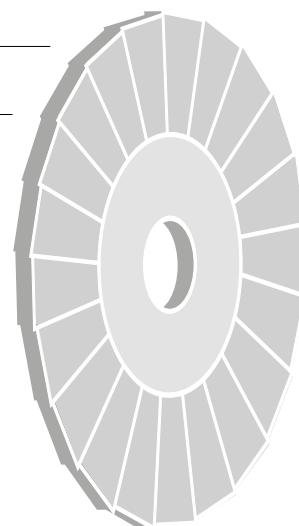

Grinding, Polishing
(flexible)

Product line marking

The product lines are illustrated by star symbols at the top of the table; please refer to page **14** and **15**.

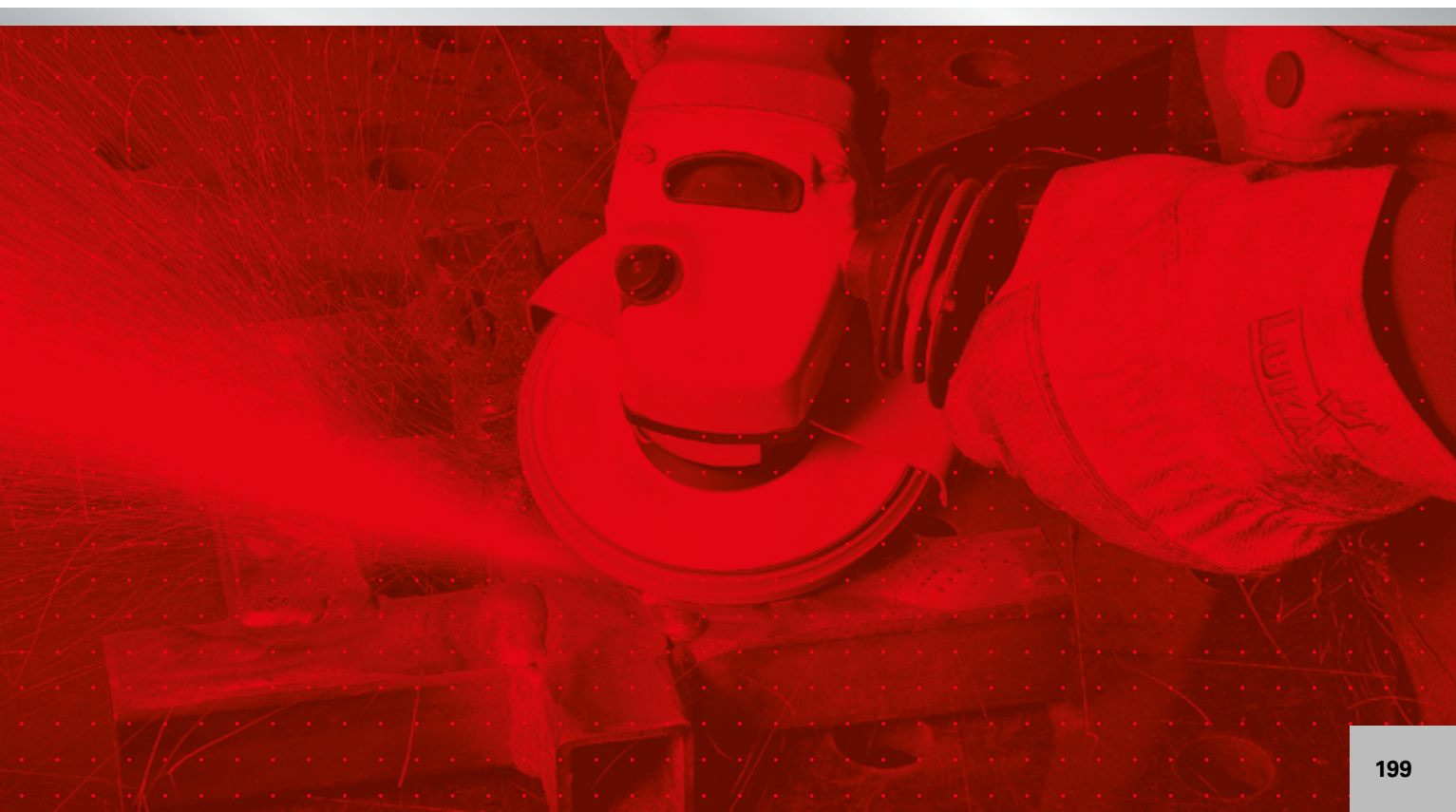

Information

General

LUKAS offers a flap disc for almost every application. These abrasive tools are produced with a wide selection of backing materials (e.g. glass fibre, resin, metal and even with a bio-degradable raw material) to suit every application. The large choice of grit sizes cover high stock removal applications (from grit size 36) to the finish machining application (grit size 240)

Ergonomics

Where lamellar flap discs are used, you can achieve clear ergonomic advantages compared to conventional grinding discs. For example, the noise level perceived is cut in half during grinding, and vibration can also be reduced considerably. In addition, the tools are generally lighter and can be used with less pressure. These advantages mean that they create a positive working climate and lead to fatigue-free working without impairing your health.

The flap discs are available in 100 mm diameter (with 16 mm bore) and in diameters 115 mm, 125 mm, 150 mm and 178 mm (22.23 mm bore); They fit all commonly used angle grinders.

You can choose between the flat or angled versions depending on application.

Examples of application::

- deburring
- fettling
- derusting
- finishing
- Machining of Welds

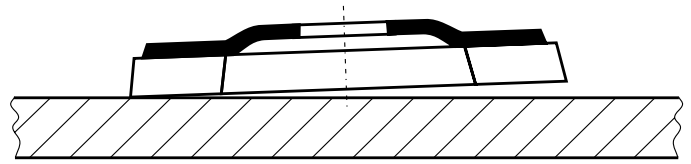

The flat shape is designed to grind edges and flat surfaces with a working angle of 0° to 15° degrees.

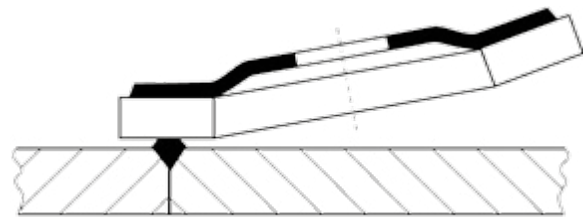

The angled shape is designed for spot grinding e.g. a weld seam with an ideal working angle of 15° to 25° degrees.

Developed for high-performance applications.

Tools of our High Performance Line have been integrated into our iQ-Series product group. Flap Discs in this product group guarantee the highest level of grinding performance due to a patented lamella shape and orientation.



SLTT
iQ Series



V2 Power
iQ Series



SLTflex
iQ Series



V4 Purple Power
iQ Series

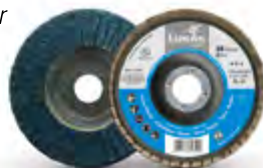

V4 Master
iQ Series



Purple Grain
iQ Series

Grinding, Polishing
(flexible)



iQ Series

Innovative quality made by LUKAS

Purple Grain - Aggressive. Durable. Ergonomic.

Power packs for your heavy-duty applications



Ideal for

- Machining weld seams
- Bevelling
- Removing large quantities of material

Properties

- high stability and durability
- integrated backing pad in recycled fibre
- uniform wear and tear without overheating

Grinding, Polishing
(flexible)

**Purple
Grain**
iQ Series



innovative
ceramic grain

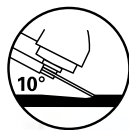

grinding
angle < 10°



no backing pad
required



low-vibration

THE POWER OF
PURPLE GRAIN

Purple Grain Single compact grinding disc

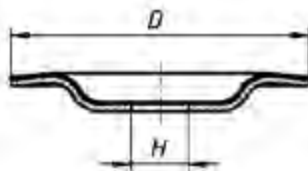

Ordering example: A27601150361547

v_{max}: 80 m/s

Ceramic = Abrasive cloth ceramic grain

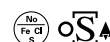

PG 5

Product number	Description	Grit	D mm	H mm	n max. (1/min)	recommended for Information on page 438		
A27601150361547	PURPLE GRAIN SINGLE 115	Ceramic 36	115	22,23	13.300	1 2 3 4 5 6 7	■	10
A27601250361547	PURPLE GRAIN SINGLE 125	Ceramic 36	125	22,23	12.200	1 2 3 4 5 6 7	■	10

Purple Grain Single: The dynamic all-roander with a long service life

Even with the use of very little force, „Purple Grain Single“ achieves removal rates with a „wow“ effect. The integrated backing pad made of environment-friendly recycled fibre guarantees a high degree of stability and durability. The innovative structure allows uniform wear and tear without overheating, embrittlement or eruptions. The deep offset zone allows you to work at a fl at angle. Thanks to its special tool geometry, the „Purple Grain Single“ can also reach inaccessible areas, thus offering more possible applications than a conventional tool.

Grinding. Polishing (flexible)

Compact grinding disc Purple Grain Multi

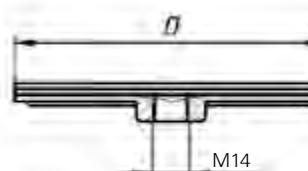

Ordering example: A27621150361547

v_{max}: 80 m/s

Ceramic = Abrasive cloth ceramic grain

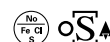

PG 5

Product number	Description	Grit	D mm	Thread	n max. (1/min)	recommended for Information on page 438		
A27621150361547	PURPLE GRAIN MULTI 115	Ceramic 36	115	M14	13.300	1 2 3 4 5 6 7	■	10
A27621250361547	PURPLE GRAIN MULTI 125	Ceramic 36	125	M14	12.200	1 2 3 4 5 6 7	■	10

Purple Grain Multi: Three times the removal rate!

With its unique multilayer design, the powerful „Purple Grain Multi“ achieves maximum service life. The wear of the three grinding layers remains under control right up to the end. This is reflected in measurable cost savings compared with conventional tools. The integrated M14 threaded holder ensures superfast tool changes without an annoying clamping nut. With its flat tool geometry, the „Purple Grain Multi“ achieves very good finishes, thus avoiding the need for reworking.

CERAMIC

Self-sharpening ceramic grain ensures consistently aggressive, cool grinding with at the same time low contact pressure. The tools remain aggressive in their grinding capacity, right down to the last grain.



Innovative ceramic grain



Ceramic grain: aggressive right to the very end

SLTT – for highest chip removal!

Feel the efficiency compared to grinding wheels or conventional lamellar flap discs.



Ideal for

- removing weld seams
- deburring & fettling
- fine finishing & rust removal

Characteristics

- exceptional stock-removal capability
- enormous tool life
- strong steel backing plate
- quite & less vibration

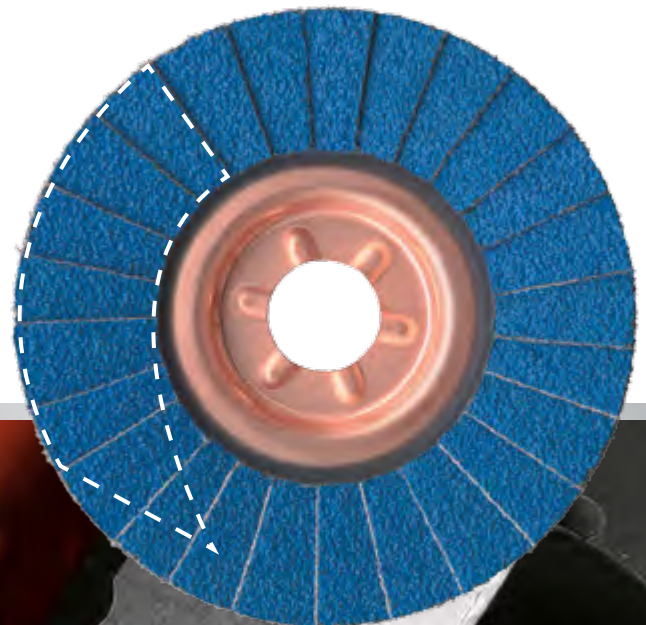

SLTT
iQ Series

A patented new design and configuration of flaps
(more grains in action)



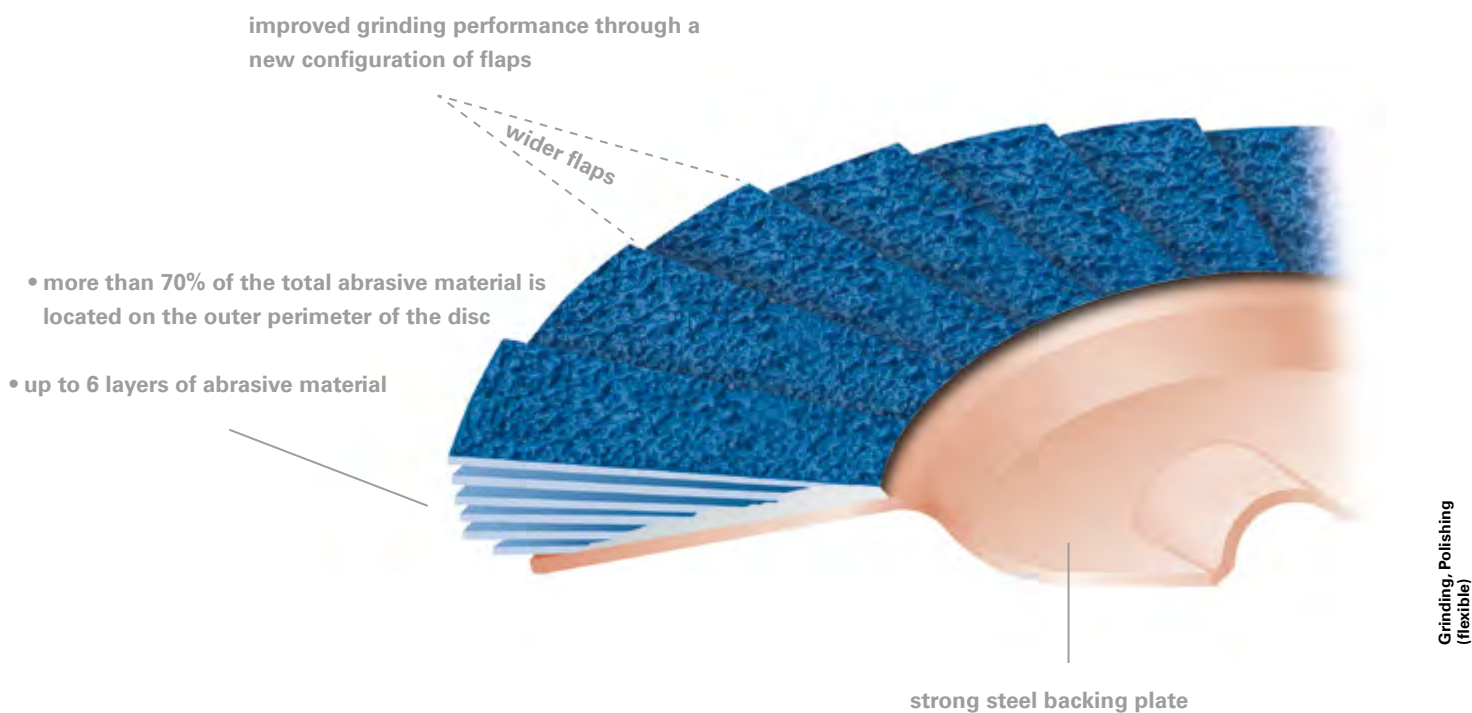

The three qualities of the iQ series:

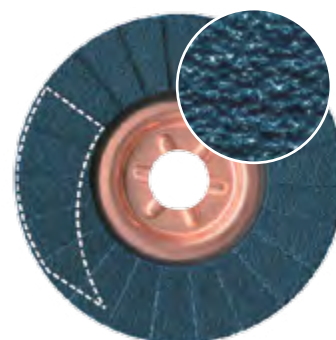
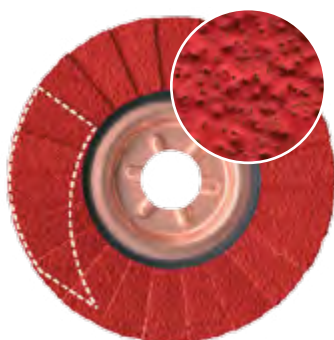
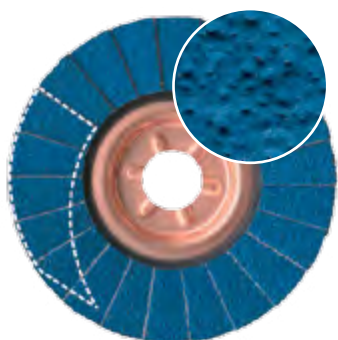

Inox Z-Power coated abrasive	Heavy Duty Ceramic coated abrasive	Steel ZK coated abrasive
<ul style="list-style-type: none"> • recently developed for the machining of stainless steel • no glazing or heating of flaps, owing to top size coating • equally efficient for both edge and surface applications • iron-sulphur-chlorine free 	<ul style="list-style-type: none"> • recently developed for the most demanding and severe applications • particularly robust for edge grinding, on heat treated steels, surface scale or coated surfaces • iron-sulphur-chlorine free 	<ul style="list-style-type: none"> • optimized for universal application on a wide variety of steels and aluminium • tough grain with a high degree of resistance to pressure • quicker, more aggressive and longer tool life when compared with our current ZKS quality

SLTT Heavy Duty, our Turbo Flap Disc for roughest application



★★★

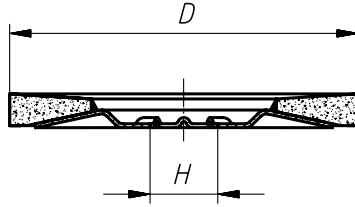

Ordering example: A27201150400050

v_{max.}: 80 m/s

Ceramic = Abrasive cloth ceramic grain



PG 5

Product number	Description	Grit	D mm	H mm	n max. (1/min)	recommended for Information on page 438		
A27201150400050	SLTT 115	Ceramic 40	115	22,23	13.300	① ② ③ ④ ⑤ ⑥ ⑦ ⑧	■	10
A27201150600050	SLTT 115	Ceramic 60	115	22,23	13.300	① ② ③ ④ ⑤ ⑥ ⑦ ⑧	■	10
A27201250400050A	SLTT 125	Ceramic 40	125	22,23	12.200	① ② ③ ④ ⑤ ⑥ ⑦ ⑧	■	10
A27201250600050	SLTT 125	Ceramic 60	125	22,23	12.200	① ② ③ ④ ⑤ ⑥ ⑦ ⑧	■	10
A27201500400050	SLTT 150	Ceramic 40	150	22,23	10.200	① ② ③ ④ ⑤ ⑥ ⑦ ⑧	■	10
A27201780400050	SLTT 178	Ceramic 40	178	22,23	8.500	① ② ③ ④ ⑤ ⑥ ⑦ ⑧	■	10
A27201780600050	SLTT 178	Ceramic 60	178	22,23	8.500	① ② ③ ④ ⑤ ⑥ ⑦ ⑧	■	10

Properties:

- particularly robust for edge grinding, on heat treated steels, surface scale or coated surfaces
- iron-sulphur-chlorine free

SLTT INOX, our Turbo Flap Disc to work on stainless steel



★★★

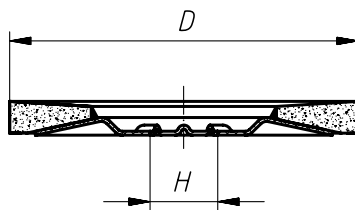

Ordering example: A27201150400045

v_{max.}: 80 m/s

Z Power = Abrasive cloth using Zirconia Alum. Oxide with special coating containing active grinding additives



PG 5

Product number	Description	Grit	D mm	H mm	n max. (1/min)	recommended for Information on page 438		
A27201150400045	SLTT 115	Z Power 40	115	22,23	13.300	① ② ③ ④	■	10
A27201150600045	SLTT 115	Z Power 60	115	22,23	13.300	① ② ③ ④	■	10
A27201250400045A	SLTT 125	Z Power 40	125	22,23	12.200	① ② ③ ④	■	10
A27201250600045	SLTT 125	Z Power 60	125	22,23	12.200	① ② ③ ④	■	10
A27201500400045	SLTT 150	Z Power 40	150	22,23	10.200	① ② ③ ④	■	10
A27201780400045	SLTT 178	Z Power 40	178	22,23	8.500	① ② ③ ④	■	10
A27201780600045	SLTT 178	Z Power 60	178	22,23	8.500	① ② ③ ④	■	10

Properties:

- No glazing or heating of flaps
- equally efficient for both edge and surface applications
- iron-sulphur-chlorine free

SLTT Steel, our Turbo Flap Disc for universal application on steel and aluminium



Ordering example: A27201150400065

v_{max.}: 80 m/s

ZK = Abrasive cloth with Zirconia Alum. Oxide

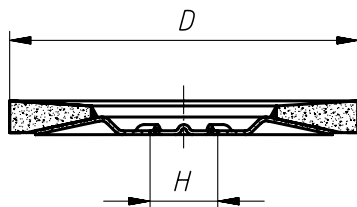

PG 5

Product number	Description	Grit	D mm	H mm	n max. (1/min)	recommended for Information on page 438		
A27201150400065	SLTT 115	ZK 40	115	22,23	13.300	① ② ③ ④ ⑤ ⑥ ⑦ ⑧	■	10
A27201150600065	SLTT 115	ZK 60	115	22,23	13.300	① ② ③ ④ ⑤ ⑥ ⑦ ⑧	■	10
A27201250600065	SLTT 125	ZK 60	125	22,23	12.200	① ② ③ ④ ⑤ ⑥ ⑦ ⑧	■	10
A27201250400065A	SLTT 125	ZK 40	125	22,23	12.200	① ② ③ ④ ⑤ ⑥ ⑦ ⑧	■	10
A27201500400065	SLTT 150	ZK 40	150	22,23	10.200	① ② ③ ④ ⑤ ⑥ ⑦ ⑧	■	10
A27201500600065	SLTT 150	ZK 60	150	22,23	10.200	① ② ③ ④ ⑤ ⑥ ⑦ ⑧	■	10
A27201780400065	SLTT 178	ZK 40	178	22,23	8.500	① ② ③ ④ ⑤ ⑥ ⑦ ⑧	■	10
A27201780600065	SLTT 178	ZK 60	178	22,23	8.500	① ② ③ ④ ⑤ ⑥ ⑦ ⑧	■	10

Properties:

- tough grain with a high degree of resistance to pressure
- quicker, more aggressive and longer tool life when compared with our current Alum. Oxide ZKS quality

Grinding, Polishing (flexible)

V2 Power – for general purpose!

Feel the efficiency compared to conventional lamellar flap discs.



Ideal for

- removing weld seams
- deburring & fettling
- fine finishing & rust removal

Characteristics

- exceptional stock-removal capability
- outstanding tool life
- robust fibre backing plate

V2 Power
iQ Series

A patented new design and configuration
of flaps
(more grains in action)

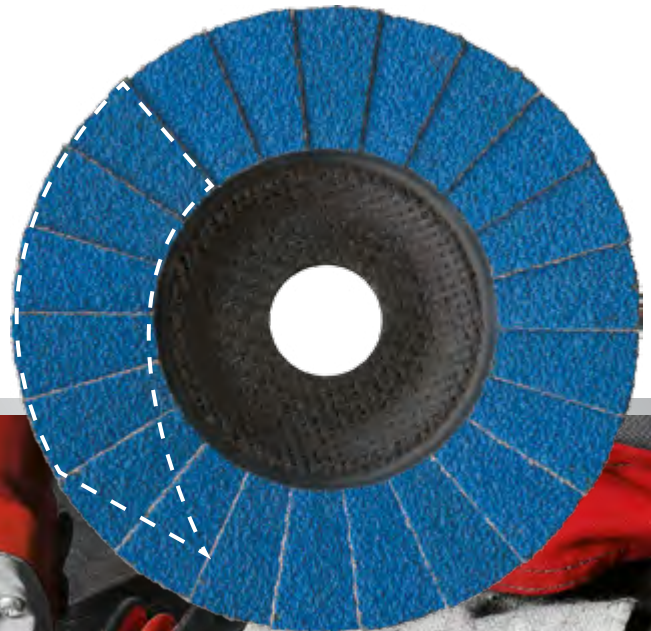

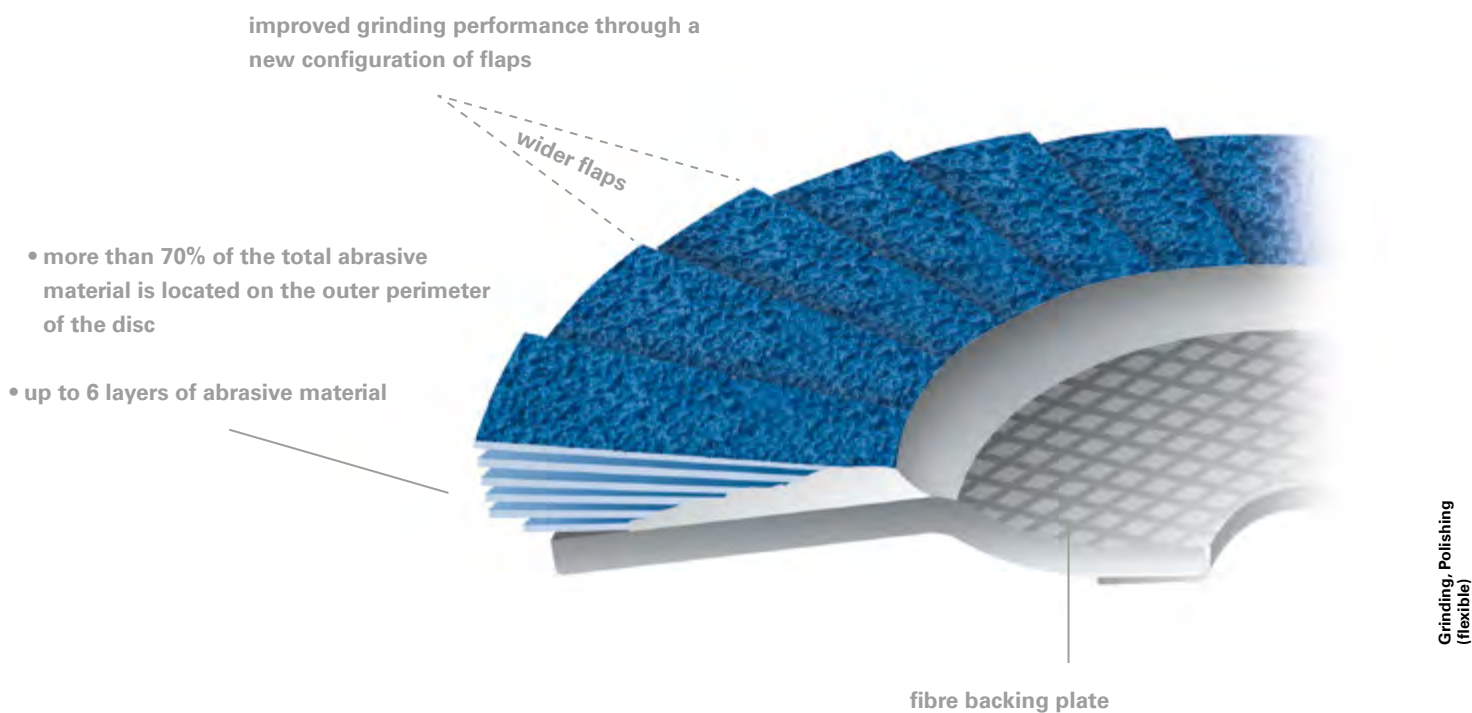

The four qualities in the iQ Series – for all materials and for every application!

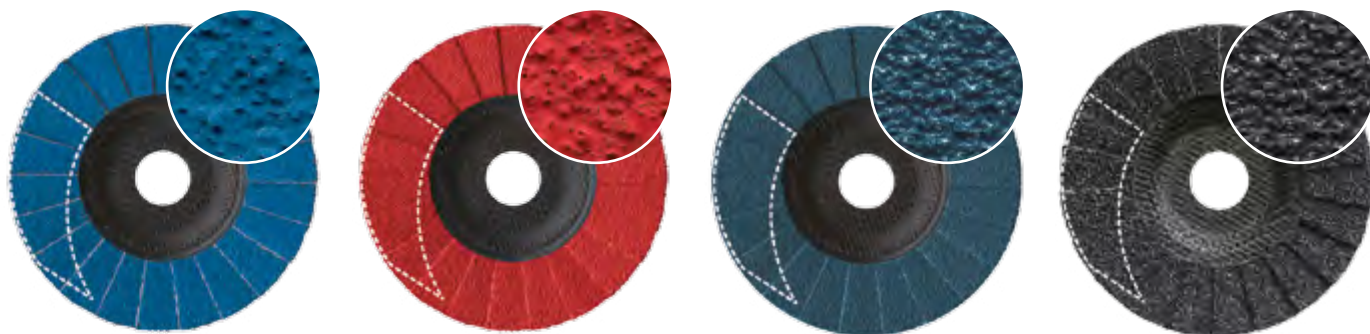

Inox Z-Power coated abrasive	Heavy Duty Ceramic coated abrasive	Steel ZK coated abrasive	ALU SIC – coated abrasive
<ul style="list-style-type: none"> • recently developed for the machining of stainless steel • no glazing or heating of flaps, owing to top size coating • equally efficient for both edge and surface applications • iron-sulphur-chlorine free 	<ul style="list-style-type: none"> • recently developed for the most demanding and severe applications • particularly robust for edge grinding, on heat treated steels, surface scale or coated surfaces • iron-sulphur-chlorine free 	<ul style="list-style-type: none"> • optimized for universal application on a wide variety of steels and aluminium • tough grain with a high degree of resistance to pressure • quicker, more aggressive and longer tool life when compared with our current ZKS quality 	<ul style="list-style-type: none"> • specially suited for weld preparation and finishing of aluminium • also ideal for fibre reinforced materials such as CRP and GRP

V2 Power Heavy Duty for roughest application

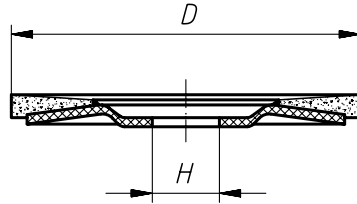

Ordering example: A27441150401450

v_{max}: 80 m/s

Ceramic = ceramic grain



PG 5

Product number	Description	Grit	D mm	H mm	n max. (1/min)	recommended for Information on page 438		
A27441150401450	V2 POWER 115	Ceramic 40	115	22,23	13.300	① ② ③ ④ ⑤ ⑥ ⑦ ⑧	■	10
A27441150601450	V2 POWER 115	Ceramic 60	115	22,23	13.300	① ② ③ ④ ⑤ ⑥ ⑦ ⑧	■	10
A27441250401450	V2 POWER 125	Ceramic 40	125	22,23	12.200	① ② ③ ④ ⑤ ⑥ ⑦ ⑧	■	10
A27441250601450	V2 POWER 125	Ceramic 60	125	22,23	12.200	① ② ③ ④ ⑤ ⑥ ⑦ ⑧	■	10
A27441780401450	V2 POWER 178	Ceramic 40	178	22,23	8.500	① ② ③ ④ ⑤ ⑥ ⑦ ⑧	■	10
A27441780601450	V2 POWER 178	Ceramic 60	178	22,23	8.500	① ② ③ ④ ⑤ ⑥ ⑦ ⑧	■	10
A27442300401428	V2 POWER 230	Ceramic 40	230	22,23	6.600	① ② ③ ④ ⑤ ⑥ ⑦ ⑧	■	10

Properties:

- particularly robust for edge grinding, on heat treated steels, surface scale or coated surfaces
- iron-sulphur-chlorine free

Grinding, Polishing
(flexible)

V2 Power Inox to work on stainless steel

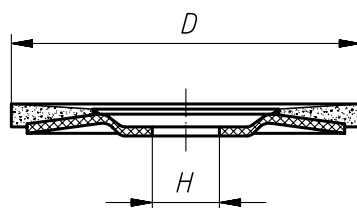

Ordering example: A27441150401445

v_{max}: 80 m/s

Z Power = Abrasive cloth using Zirconia Alum. Oxide with special coating containing active grinding additives



PG 5

Product number	Description	Grit	D mm	H mm	n max. (1/min)	recommended for Information on page 438		
A27441150401445	V2 POWER 115	Z Power 40	115	22,23	13.300	① ② ③ ④	■	10
A27441150601445	V2 POWER 115	Z Power 60	115	22,23	13.300	① ② ③ ④	■	10
A27441250401445	V2 POWER 125	Z Power 40	125	22,23	12.200	① ② ③ ④	■	10
A27441250601445	V2 POWER 125	Z Power 60	125	22,23	12.200	① ② ③ ④	■	10
A27441780401445	V2 POWER 178	Z Power 40	178	22,23	8.500	① ② ③ ④	■	10
A27441780601445	V2 POWER 178	Z Power 60	178	22,23	8.500	① ② ③ ④	■	10

Properties:

- no glazing or heat generation
- equally efficient for both edge and surface applications
- iron-sulphur-chlorine free

V2 Power Steel for universal application on steel and aluminium

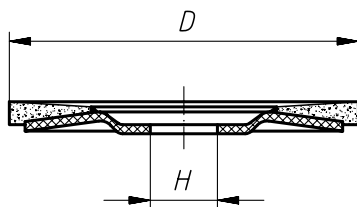
★★★

Ordering example: A27441000401465

 $v_{max.}: 80 \text{ m/s}$

ZK = Abrasive cloth with Zirconia

Alum. Oxide ZKS = Zirconia Alum.

Oxide with special coating containing active grinding additives

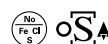
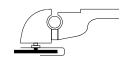
iQ Series

PG 5

Product number	Description	Grit	D mm	H mm	n max. (1/min)	recommended for Information on page 438		
A27441000401465	V2 POWER 100	ZK 40	100	16	15.300	① ② ③ ④ ⑤ ⑥ ⑦ ⑧	■	10
A27441000601465	V2 POWER 100	ZK 60	100	16	15.300	① ② ③ ④ ⑤ ⑥ ⑦ ⑧	■	10
A27441150401465	V2 POWER 115	ZK 40	115	22,23	13.300	① ② ③ ④ ⑤ ⑥ ⑦ ⑧	■	10
A27441150601465	V2 POWER 115	ZK 60	115	22,23	13.300	① ② ③ ④ ⑤ ⑥ ⑦ ⑧	■	10
A27441250401465	V2 POWER 125	ZK 40	125	22,23	12.200	① ② ③ ④ ⑤ ⑥ ⑦ ⑧	■	10
A27441250601465	V2 POWER 125	ZK 60	125	22,23	12.200	① ② ③ ④ ⑤ ⑥ ⑦ ⑧	■	10
A27441780401465	V2 POWER 178	ZK 40	178	22,23	8.500	① ② ③ ④ ⑤ ⑥ ⑦ ⑧	■	10
A27441780601465	V2 POWER 178	ZK 60	178	22,23	8.500	① ② ③ ④ ⑤ ⑥ ⑦ ⑧	■	10
A27442300401418	V2 POWER 230	ZKS 40	230	22,23	6.600	① ② ③ ④ ⑤ ⑥ ⑦ ⑧	■	5

Properties:

- tough grain with a high degree of resistance to pressure

Grinding, Polishing (flexible)

V2 Power ALU

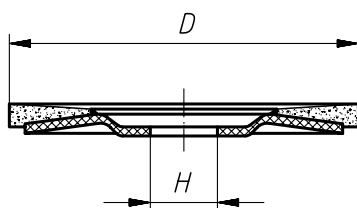
★★★

Ordering example: A27441150361434

 $v_{max.}: 80 \text{ m/s}$

SIC = Siliciumcarbide

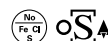
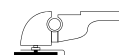
iQ Series

PG 5

Product number	Description	Grit	D mm	H mm	n max. (1/min)	recommended for Information on page 438		
A27441150361434	V2 POWER 115	SIC 36	115	22,23	13.300	⑥ ⑦ ⑧	■	10
A27441150401434	V2 POWER 115	SIC 40	115	22,23	13.300	⑥ ⑦ ⑧	■	10
A27441250361434	V2 POWER 125	SIC 36	125	22,23	12.200	⑥ ⑦ ⑧	■	10
A27441250401434	V2 POWER 125	SIC 40	125	22,23	12.200	⑥ ⑦ ⑧	■	10
A27441780241434	V2 POWER 178	SIC 24	178	22,23	8.500	⑥ ⑦ ⑧	■	10
A27441780361434	V2 POWER 178	SIC 36	178	22,23	8.500	⑥ ⑦ ⑧	■	10

Properties:

- Silicon carbide (SIC) ideally suited for preparation and finishing of weld seams with various aluminium alloys
- Silicon carbide (SIC) ideally suited for the machining of contemporary workpiece materials such as CRP or GRP

V4 Purple Power – for the use of robots

Extreme grinding performance in industrial applications

Ideal for

- the use on grinding robots
- grinding machines and
- strong power plants

Advantages

- extreme removal rate
- less tool change
- high ergonomics

V4
Purple Power
iQ Series



V4 Purple Power



★★★

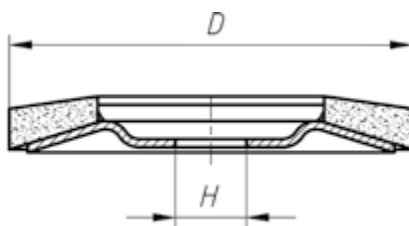

Ordering example: A274812503600475

vmax.: 80 m/s

Ceramic = ceramic grain

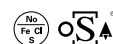

PG 0

Product number	Description	Grit	D mm	n max. (1/min)	recommended for Information on page 438		
A274812503600475	V4 PURPLE-POWER 125	Ceramic 36	125	12.200	<input checked="" type="checkbox"/> 1 <input checked="" type="checkbox"/> 2 <input checked="" type="checkbox"/> 3 <input checked="" type="checkbox"/> 4 <input checked="" type="checkbox"/> 5 <input checked="" type="checkbox"/> 6 <input checked="" type="checkbox"/> 7	<input checked="" type="checkbox"/>	5

V4 Purple Power – for the use of robots

Extreme grinding performance in industrial applications

Ideal for

- the use on grinding robots,
- grinding machines and
- strong power plants

Advantages:

- extreme removal rate
- less tool change
- high ergonomics

Grinding, Polishing
(flexible)

V4 Master – extremely aggressive and durable



Areas of application

- rounding sharp edges
- removing weld seams
- treatment of thermal cuts

Customized for your industry:

- Steel and tank construction
- Shipyards and offshore
- Machine and plant engineering

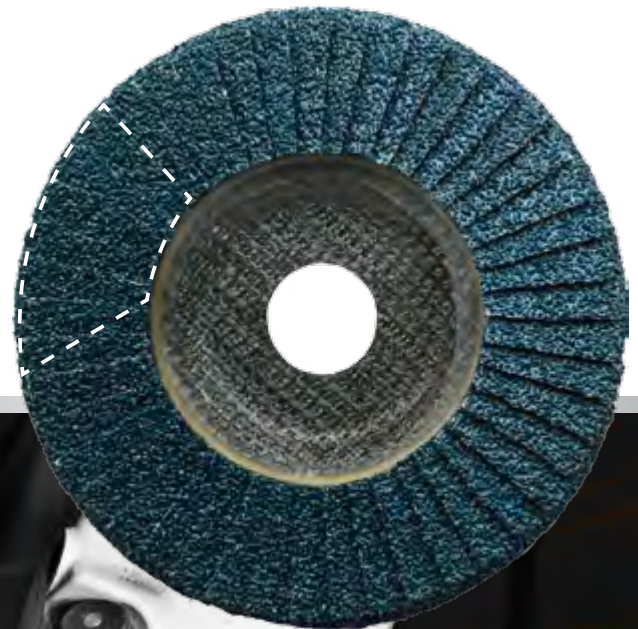

V4 Master
iQ Series



V4 Master – Master of its class



Ordering example: A27471150401465

v_{max.}: 80 m/s

ZK = Abrasive cloth with Zirconia Alum. Oxide

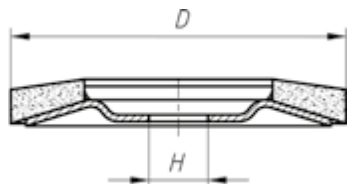

PG 5

Product number	Description	Grit	D mm	H mm	n max. (1/min)	recommended for Information on page 438		
A27471150401465	V4 MASTER 115	ZK 40	115	22,23	13.300	1 2 3 4 6 7	■	10
A27471150601465	V4 MASTER 115	ZK 60	115	22,23	13.300	1 2 3 4 6 7	■	10
A27471250401465	V4 MASTER 125	ZK 40	125	22,23	12.200	1 2 3 4 6 7	■	10
A27471250601465	V4 MASTER 125	ZK 60	125	22,23	12.200	1 2 3 4 6 7	■	10
A27471780401465	V4 MASTER 178	ZK 40	178	22,23	8.500	1 2 3 4 6 7	■	10

Characteristics:

- extreme stock removal
- good edge retention
- deep recess around the bore
- long tool life
- low noise and low vibration
- ergonomically due to less effort
- iron-sulphur-chlorine free

Grinding, Polishing (flexible)

SLTflex – for the awkward areas!

Feel the efficiency compared to conventional lamellar flap discs or fibre discs.



Ideal for:

- machining of fillet welds
- deburring & fettling
- fine finishing & rust removal

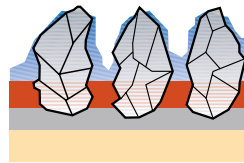

Using a high quality coated abrasive (zirconia with a coating of active grinding additives)

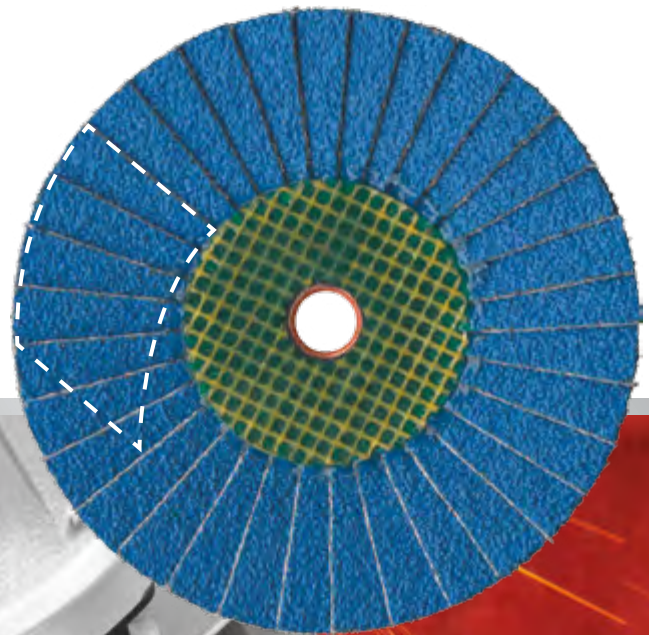

SLTflex
iQ Series



SLTflex Ceramic, the powerful disc for radii and fillet welds



★★★

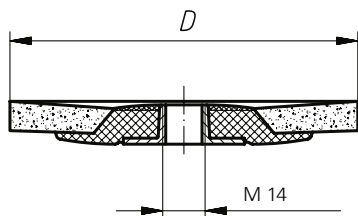

Ordering example: A272711504070

v_{max.}: 80 m/s

Ceramic = ceramic grain

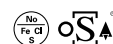

PG 5

Product number	Description	Grit	D mm	Thread	n max (1/min)	recommended for Information on page 438		
A272711504070	SLTflex 115	Ceramic 40	115	M14	13.300	① ② ③ ④ ⑤ ⑥ ⑦	■	10
A272711506070	SLTflex 115	Ceramic 60	115	M14	13.300	① ② ③ ④ ⑤ ⑥ ⑦	■	10
A272712504070	SLTflex 125	Ceramic 40	125	M14	12.200	① ② ③ ④ ⑤ ⑥ ⑦	■	10
A272712506070	SLTflex 125	Ceramic 60	125	M14	12.200	① ② ③ ④ ⑤ ⑥ ⑦	■	10

Properties:

- high flexibility due to elongated flaps (no disturbing backing plate)
- simple tool change (backing plate / pad and mounting nut no longer required)
- extreme tool life



Grinding, Polishing (flexible)

SLTs-flex superflexibel

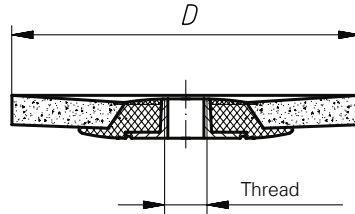
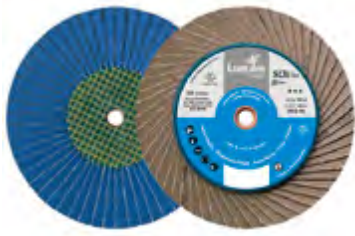

Ordering example: A272910004018

vmax.: 80 m/s

Ø 100 mm: 63 m/s

Alum. Oxide ZKS = Zirconia Alum.
Oxide with special coating containing active grinding additives



PG 5

Product number	Description	Grit	D mm	Thread	n max (1/min)	recommended for Information on page 438		
A272910004018	SLTs-flex 100	ZKS 40	100	M10	12.100	① ② ③ ④ ⑤ ⑥ ⑦	■	10
A272910006018	SLTs-flex 100	ZKS 60	100	M10	12.100	① ② ③ ④ ⑤ ⑥ ⑦	■	10
A272910008018	SLTs-flex 100	ZKS 80	100	M10	12.100	① ② ③ ④ ⑤ ⑥ ⑦	■	10
A672911504018	SLTs-flex 115	ZKS 40	115	M14	13.300	① ② ③ ④ ⑤ ⑥ ⑦	■	10
A672911506018	SLTs-flex 115	ZKS 60	115	M14	13.300	① ② ③ ④ ⑤ ⑥ ⑦	■	10
A672911508018	SLTs-flex 115	ZKS 80	115	M14	13.300	① ② ③ ④ ⑤ ⑥ ⑦	■	10
A672912504018	SLTs-flex 125	ZKS 40	125	M14	12.200	① ② ③ ④ ⑤ ⑥ ⑦	■	10
A672912506018	SLTs-flex 125	ZKS 60	125	M14	12.200	① ② ③ ④ ⑤ ⑥ ⑦	■	10
A672912508018	SLTs-flex 125	ZKS 80	125	M14	12.200	① ② ③ ④ ⑤ ⑥ ⑦	■	10
A272917804018	SLTs-flex 178	ZKS 40	178	M14	8.500	① ② ③ ④ ⑤ ⑥ ⑦	■	10
A272917806018	SLTs-flex 178	ZKS 60	178	M14	8.500	① ② ③ ④ ⑤ ⑥ ⑦	■	10
A272917808018	SLTs-flex 178	ZKS 80	178	M14	8.500	① ② ③ ④ ⑤ ⑥ ⑦	■	10

Properties:

- even further projecting flaps
- more flexibility
- M14 quick-release screw thread

Advantages:

- super soft grinding
- for perfect surfaces
- fast tool change
- no backing plate and mounting nut required

Grinding, Polishing
(flexible)

SLTflex – for radii and fillet weldings



★★★

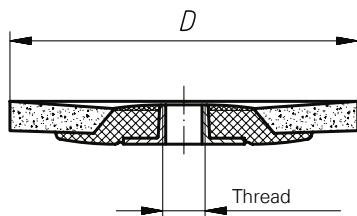

Ordering example: A272711504018

v_{max.}: 80 m/s
 Ø 100 mm: 63 m/s

iQ Series

ZK = Abrasive cloth with Zirconia Alum. Oxide

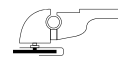

ZKS = Zirconia Alum. Oxide with special coating containing active grinding additives



PG 5

Product number	Description	Grit	D mm	Thread	n max (1/min)	recommended for Information on page 438		
A272711504018	SLTflex 115	ZKS 40	115	M14	13.300	1 2 3 4 5 6 7	■	10
A272811504018	SLTflex 115	ZKS 40	115	5/8"	13.300	1 2 3 4 5 6 7	■	10
A272711506018	SLTflex 115	ZKS 60	115	M14	13.300	1 2 3 4 5 6 7	■	10
A272811506018	SLTflex 115	ZKS 60	115	5/8"	13.300	1 2 3 4 5 6 7	■	10
A272711508016	SLTflex 115	ZK 80	115	M14	13.300	1 2 3 4 5 6 7	■	10
A272811508018	SLTflex 115	ZK 80	115	5/8"	13.300	1 2 3 4 5 6 7	■	10
A272711512016	SLTflex 115	ZK 120	115	M14	13.300	1 2 3 4 5 6 7	■	10
A272811512018	SLTflex 115	ZK 120	115	5/8"	13.300	1 2 3 4 5 6 7	■	10
A272712504018	SLTflex 125	ZKS 40	125	M14	12.200	1 2 3 4 5 6 7	■	10
A272812504018	SLTflex 125	ZKS 40	125	5/8"	12.200	1 2 3 4 5 6 7	■	10
A272712506018	SLTflex 125	ZKS 60	125	M14	12.200	1 2 3 4 5 6 7	■	10
A272812506018	SLTflex 125	ZKS 60	125	5/8"	12.200	1 2 3 4 5 6 7	■	10
A272712508016	SLTflex 125	ZK 80	125	M14	12.200	1 2 3 4 5 6 7	■	10
A272812508018	SLTflex 125	ZK 80	125	5/8"	12.200	1 2 3 4 5 6 7	■	10
A272712512016	SLTflex 125	ZK 120	125	M14	12.200	1 2 3 4 5 6 7	■	10
A272812512018	SLTflex 125	ZK 120	125	5/8"	12.200	1 2 3 4 5 6 7	■	10

Properties:

- high flexibility due to elongated flaps (no disturbing backing plate)
- simple tool change (backing plate / pad and mounting nut no longer required)
- long life

Grinding, Polishing (flexible)

Lamellar Flap Discs SLTR Control

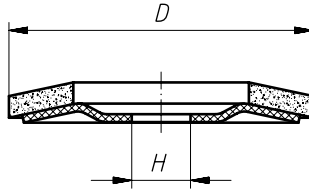

Ordering example: A27461150401406

v_{max.}: 80 m/s

ZK = Zirconia Alum. Oxide

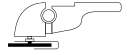

PG 6

Product number	Description	Grit	D mm	H mm	n max. (1/min)	recommended for Information on page 438		
A27461150401406	SLTR 115 Control	ZK 40 INOX	115	22,23	13.300	1 2 3 4 5 7	■	10
A27461150601406	SLTR 115 Control	ZK 60 INOX	115	22,23	13.300	1 2 3 4 5 7	■	10
A27461150801406	SLTR 115 Control	ZK 80 INOX	115	22,23	13.300	1 2 3 4 5 7	■	10
A27461250401406	SLTR 125 Control	ZK 40 INOX	125	22,23	12.200	1 2 3 4 5 7	■	10
A27461250601406	SLTR 125 Control	ZK 60 INOX	125	22,23	12.200	1 2 3 4 5 7	■	10
A27461250801406	SLTR 125 Control	ZK 80 INOX	125	22,23	12.200	1 2 3 4 5 7	■	10

- check continuously the ongoing process
- protect any sensitive surfaces from damage during the grinding process

Grinding, Polishing
(flexible)

The SLTZ, with special active grinding additives

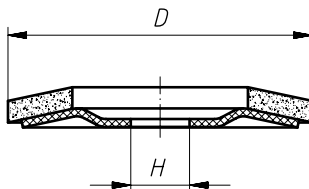

Ordering example: A27261150401418

v_{max.}: 80 m/s

ISO 15635

ZKS = Zirconia Alum. Oxide with special coating containing active grinding additives

SLTZ = dished

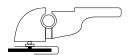

PG 6

Product number	Description	Grit	D mm	H mm	n max. (1/min)	recommended for Information on page 438		
A27261150401418	SLTZ 115	ZKS 40	115	22,23	13.300	2 3 4 5 7	■	10
A27261150601418	SLTZ 115	ZKS 60	115	22,23	13.300	2 3 4 5 7	■	10
A27261150801418	SLTZ 115	ZKS 80	115	22,23	13.300	2 3 4 5 7	■	10
A27261250401418	SLTZ 125	ZKS 40	125	22,23	12.200	2 3 4 5 7	■	10
A27261250601418	SLTZ 125	ZKS 60	125	22,23	12.200	2 3 4 5 7	■	10
A27261250801418	SLTZ 125	ZKS 80	125	22,23	12.200	2 3 4 5 7	■	10

Properties:

- high quality coated abrasive containing special active grinding additives
- top grinding performance
- outstanding tool life

Applicaton:

- shipbuilding
- steel construction work
- stainless steel
- and many other applications

Characteristics:

- suitable for most materials
- can be used for deburring, fettling, derusting and finishing

SLTO/SLTR, the powerful performer with the glass-fibre backing plate



★★★

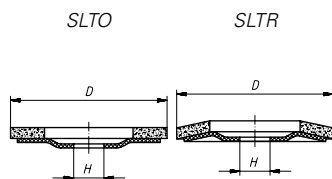

Ordering example: A27231150401428

v_{max.}: 80 m/s

ISO 15635

Ceramic = ceramic grain

SLTO = flat

SLTR = dished

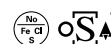

PG 6

Product number	Description	Grit	D mm	H mm	n max. (1/min)	recommended for Information on page 438		
A27251150401428	SLTO 115	Ceramic 40	115	22,23	13.300	① ② ③ ④ ⑤ ⑥ ⑦ ⑧	■	10
A27251250401428	SLTO 125	Ceramic 40	125	22,23	12.200	① ② ③ ④ ⑤ ⑥ ⑦ ⑧	■	10
A27251250601428	SLTO 125	Ceramic 60	125	22,23	12.200	① ② ③ ④ ⑤ ⑥ ⑦ ⑧	■	10
A27251250801428	SLTO 125	Ceramic 80	125	22,23	12.200	① ② ③ ④ ⑤ ⑥ ⑦ ⑧	■	10
A27231150401428	SLTR 115	Ceramic 40	115	22,23	13.300	① ② ③ ④ ⑤ ⑥ ⑦ ⑧	■	10
A27231150601428	SLTR 115	Ceramic 60	115	22,23	13.300	① ② ③ ④ ⑤ ⑥ ⑦ ⑧	■	10
A27231150801428	SLTR 115	Ceramic 80	115	22,23	13.300	① ② ③ ④ ⑤ ⑥ ⑦ ⑧	■	10
A27231250401428	SLTR 125	Ceramic 40	125	22,23	12.200	① ② ③ ④ ⑤ ⑥ ⑦ ⑧	■	10
A27231250601428	SLTR 125	Ceramic 60	125	22,23	12.200	① ② ③ ④ ⑤ ⑥ ⑦ ⑧	■	10
A27231250801428	SLTR 125	Ceramic 80	125	22,23	12.200	① ② ③ ④ ⑤ ⑥ ⑦ ⑧	■	10
A27231780401428	SLTR 178	Ceramic 40	178	22,23	8.500	① ② ③ ④ ⑤ ⑥ ⑦ ⑧	■	10

Grinding, Polishing (flexible)

SLTO/SLTR, reinforced fibre backing



★★☆

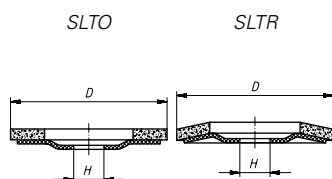

Ordering example: A27151000401423

v_{max.}: 80 m/s

ISO 15635

ZK = Zirconia Alum. Oxide

NK = reg. Aluminium Oxide

SLTO = flat

SLTR = dished

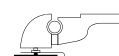

PG 6

Product number	Description	Grit	D mm	H mm	n max. (1/min)	recommended for Information on page 438		
A27151000601423	SLTO 100	ZK 60	100	16	15.300	① ② ③ ④ ⑤ ⑦	■	10
A27151000801423	SLTO 100	ZK 80	100	16	15.300	① ② ③ ④ ⑤ ⑦	■	10
A27151150401400	SLTO 115	NK 40	115	22,23	13.300	① ② ③ ④ ⑤ ⑥ ⑦ ⑧	■	10
A27151150601400	SLTO 115	NK 60	115	22,23	13.300	① ② ③ ④ ⑤ ⑥ ⑦ ⑧	■	10
A27151150801400	SLTO 115	NK 80	115	22,23	13.300	① ② ③ ④ ⑤ ⑥ ⑦ ⑧	■	10
A27151151201400	SLTO 115	NK 120	115	22,23	13.300	① ② ③ ④ ⑤ ⑥ ⑦ ⑧	■	10
A27151150361406	SLTO 115	ZK 36	115	22,23	13.300	① ② ③ ④ ⑤ ⑦	■	10
A27151150401406	SLTO 115	ZK 40	115	22,23	13.300	① ② ③ ④ ⑤ ⑦	■	10

SLTO/SLTR, reinforced fibre backing

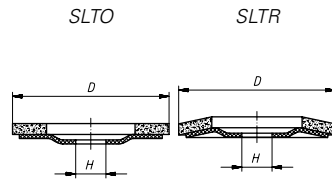

Ordering example: A27151000401423

v_{max.}: 80 m/s

ISO 15635

ZK = Zirconia Alum. Oxide

NK = reg. Aluminium Oxide

SLTO = flat

SLTR = dished

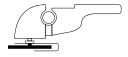

PG 6

Product number	Description	Grit	D mm	H mm	n max. (1/min)	recommended for		
						Information on page 438		
A27151150501406	SLTO 115	ZK 50	115	22,23	13.300	1 2 3 4 5 7	■	10
A27151150601406	SLTO 115	ZK 60	115	22,23	13.300	1 2 3 4 5 7	■	10
A27151150801406	SLTO 115	ZK 80	115	22,23	13.300	1 2 3 4 5 7	■	10
A27151151201406	SLTO 115	ZK 120	115	22,23	13.300	1 2 3 4 5 7	■	10
A27151250401400	SLTO 125	NK 40	125	22,23	12.200	1 2 3 4 5 6 7 8	■	10
A27151250501400	SLTO 125	NK 50	125	22,23	12.200	1 2 3 4 5 6 7 8	■	10
A27151250401406	SLTO 125	ZK 40	125	22,23	12.200	1 2 3 4 5 7	■	10
A27151250501406	SLTO 125	ZK 50	125	22,23	12.200	1 2 3 4 5 7	■	10
A27151250601406	SLTO 125	ZK 60	125	22,23	12.200	1 2 3 4 5 7	■	10
A27151250801406	SLTO 125	ZK 80	125	22,23	12.200	1 2 3 4 5 7	■	10
A27151780601400	SLTO 178	NK 60	178	22,23	8.500	1 2 3 4 5 6 7 8	■	10
A27151780361401	SLTO 178	ZK 36	178	22,23	8.500	1 2 3 4 5 7	■	10
A27151780401401	SLTO 178	ZK 40	178	22,23	8.500	1 2 3 4 5 7	■	10
A27151780601401	SLTO 178	ZK 60	178	22,23	8.500	1 2 3 4 5 7	■	10
A27151780801401	SLTO 178	ZK 80	178	22,23	8.500	1 2 3 4 5 7	■	10
A27151781201401	SLTO 178	ZK 120	178	22,23	8.500	1 2 3 4 5 7	■	10
A27181000401423	SLTR 100	ZK 40	100	16	15.300	1 2 3 4 5 7	■	10
A27181000601423	SLTR 100	ZK 60	100	16	15.300	1 2 3 4 5 7	■	10
A27181000801423	SLTR 100	ZK 80	100	16	15.300	1 2 3 4 5 7	■	10
A27181150361400	SLTR 115	NK 36	115	22,23	13.300	1 2 3 4 5 6 7 8	■	10
A27181150401400	SLTR 115	NK 40	115	22,23	13.300	1 2 3 4 5 6 7 8	■	10
A27181150601400	SLTR 115	NK 60	115	22,23	13.300	1 2 3 4 5 6 7 8	■	10
A27181150801400	SLTR 115	NK 80	115	22,23	13.300	1 2 3 4 5 6 7 8	■	10
A27181151201400	SLTR 115	NK 120	115	22,23	13.300	1 2 3 4 5 6 7 8	■	10
A27181150361406	SLTR 115	ZK 36	115	22,23	13.300	1 2 3 4 5 7	■	10
A27181150401406	SLTR 115	ZK 40	115	22,23	13.300	1 2 3 4 5 7	■	10
A27181150501406	SLTR 115	ZK 50	115	22,23	13.300	1 2 3 4 5 7	■	10
A27181150601406	SLTR 115	ZK 60	115	22,23	13.300	1 2 3 4 5 7	■	10
A27181150801406	SLTR 115	ZK 80	115	22,23	13.300	1 2 3 4 5 7	■	10
A27181151201406	SLTR 115	ZK 120	115	22,23	13.300	1 2 3 4 5 7	■	10
A27181250401400	SLTR 125	NK 40	125	22,23	12.200	1 2 3 4 5 6 7 8	■	10
A27181250601400	SLTR 125	NK 60	125	22,23	12.200	1 2 3 4 5 6 7 8	■	10
A27181250801400	SLTR 125	NK 80	125	22,23	12.200	1 2 3 4 5 6 7 8	■	10
A27181251201400	SLTR 125	NK 120	125	22,23	12.200	1 2 3 4 5 6 7 8	■	10
A27181250361406	SLTR 125	ZK 36	125	22,23	12.200	1 2 3 4 5 7	■	10
A27181250401406	SLTR 125	ZK 40	125	22,23	12.200	1 2 3 4 5 7	■	10
A27181250601406	SLTR 125	ZK 60	125	22,23	12.200	1 2 3 4 5 7	■	10

Grinding, Polishing (flexible)

SLTO/SLTR, reinforced fibre backing

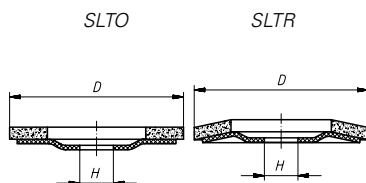

Ordering example: A27151000401423

v_{max.}: 80 m/s

ISO 15635

ZK = Zirconia Alum. Oxide

NK = reg. Aluminium Oxide

SLTO = flat

SLTR = dished

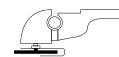

PG 6

Product number	Description	Grit	D mm	H mm	n max. (1/min)	recommended for Information on page 438		
A27181250801406	SLTR 125	ZK 80	125	22,23	12.200	① ② ③ ④ ⑤ ⑦	■	10
A27181251201406	SLTR 125	ZK 120	125	22,23	12.200	① ② ③ ④ ⑤ ⑦	■	10
A27181500401416	SLTR 150	ZK 40	150	22,23	10.200	① ② ③ ④ ⑤ ⑦	■	10
A27181500601416	SLTR 150	ZK 60	150	22,23	10.200	① ② ③ ④ ⑤ ⑦	■	10
A27181500801416	SLTR 150	ZK 80	150	22,23	10.200	① ② ③ ④ ⑤ ⑦	■	10
A27181780401400	SLTR 178	NK 40	178	22,23	8.500	① ② ③ ④ ⑤ ⑥ ⑦ ⑧	■	10
A27181780601400	SLTR 178	NK 60	178	22,23	8.500	① ② ③ ④ ⑤ ⑥ ⑦ ⑧	■	10
A27181780801400	SLTR 178	NK 80	178	22,23	8.500	① ② ③ ④ ⑤ ⑥ ⑦ ⑧	■	10
A27181780361401	SLTR 178	ZK 36	178	22,23	8.500	① ② ③ ④ ⑤ ⑦	■	10
A27181780401401	SLTR 178	ZK 40	178	22,23	8.500	① ② ③ ④ ⑤ ⑦	■	10
A27181780601401	SLTR 178	ZK 60	178	22,23	8.500	① ② ③ ④ ⑤ ⑦	■	10
A27181780801401	SLTR 178	ZK 80	178	22,23	8.500	① ② ③ ④ ⑤ ⑦	■	10
A27181781201401	SLTR 178	ZK 120	178	22,23	8.500	① ② ③ ④ ⑤ ⑦	■	10

Grinding, Polishing (flexible)

SLTO/SLTR competitively priced BASE-X, reinforced fibre backing

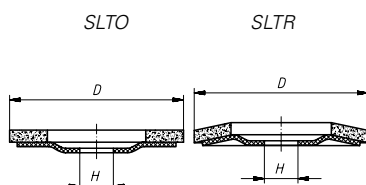

Ordering example: A27151000401501

v_{max.}: 80 m/s

ISO 15635

ZK = Zirconia Alum. Oxide

SLTO = flat

SLTR = dished

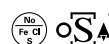
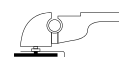

PG 6

Product number	Description	Grit	D mm	H mm	n max. (1/min)	recommended for Information on page 438		
A27151000401501	SLTO 100 BASE-X	ZK 40	100	16	15.300	① ② ③ ④ ⑤ ⑦	■	10
A27151000601501	SLTO 100 BASE-X	ZK 60	100	16	15.300	① ② ③ ④ ⑤ ⑦	■	10
A27151000801501	SLTO 100 BASE-X	ZK 80	100	16	15.300	① ② ③ ④ ⑤ ⑦	■	10
A27151001201501	SLTO 100 BASE-X	ZK 120	100	16	15.300	① ② ③ ④ ⑤ ⑦	■	10
A27151150401501	SLTO 115 BASE-X	ZK 40	115	22,23	13.300	① ② ③ ④ ⑤ ⑦	■	10

SLTO/SLTR competitively priced BASE-X, reinforced fibre backing

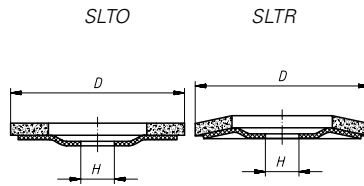

Ordering example: A27151000401501

v_{max.}: 80 m/s

ISO 15635

ZK = Zirconia Alum. Oxide

SLTO = flat

SLTR = dished

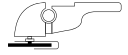

PG 6

Product number	Description	Grit	D mm	H mm	n max. (1/min)	recommended for							Information on page 438	PG 6	10
						1	2	3	4	5	7				
A27151150601501	SLTO 115 BASE-X	ZK 60	115	22,23	13.300	1	2	3	4	5	7			■	10
A27151150801501	SLTO 115 BASE-X	ZK 80	115	22,23	13.300	1	2	3	4	5	7			■	10
A27151151201501	SLTO 115 BASE-X	ZK 120	115	22,23	13.300	1	2	3	4	5	7			■	10
A27151250401501	SLTO 125 BASE-X	ZK 40	125	22,23	12.200	1	2	3	4	5	7			■	10
A27151250601501	SLTO 125 BASE-X	ZK 60	125	22,23	12.200	1	2	3	4	5	7			■	10
A27151250801501	SLTO 125 BASE-X	ZK 80	125	22,23	12.200	1	2	3	4	5	7			■	10
A27151780401501	SLTO 178 BASE-X	ZK 40	178	22,23	8.500	1	2	3	4	5	7			■	10
A27151780601501	SLTO 178 BASE-X	ZK 60	178	22,23	8.500	1	2	3	4	5	7			■	10
A27151780801501	SLTO 178 BASE-X	ZK 80	178	22,23	8.500	1	2	3	4	5	7			■	10
A27181000401501	SLTR 100 BASE-X	ZK 40	100	16	15.300	1	2	3	4	5	7			■	10
A27181000601501	SLTR 100 BASE-X	ZK 60	100	16	15.300	1	2	3	4	5	7			■	10
A27181000801501	SLTR 100 BASE-X	ZK 80	100	16	15.300	1	2	3	4	5	7			■	10
A27181001201501	SLTR 100 BASE-X	ZK 120	100	16	15.300	1	2	3	4	5	7			■	10
A27181150401501	SLTR 115 BASE-X	ZK 40	115	22,23	13.300	1	2	3	4	5	7			■	10
A27181150601501	SLTR 115 BASE-X	ZK 60	115	22,23	13.300	1	2	3	4	5	7			■	10
A27181150801501	SLTR 115 BASE-X	ZK 80	115	22,23	13.300	1	2	3	4	5	7			■	10
A27181151001501	SLTR 115 BASE-X	ZK 100	115	22,23	13.300	1	2	3	4	5	7			■	10
A27181250401501	SLTR 125 BASE-X	ZK 40	125	22,23	12.200	1	2	3	4	5	7			■	10
A27181250601501	SLTR 125 BASE-X	ZK 60	125	22,23	12.200	1	2	3	4	5	7			■	10
A27181250801501	SLTR 125 BASE-X	ZK 80	125	22,23	12.200	1	2	3	4	5	7			■	10
A67181251201501	SLTR 125 BASE-X	ZK 120	125	22,23	12.200	1	2	3	4	5	7			■	10
A27181780401501	SLTR 178 BASE-X	ZK 40	178	22,23	8.500	1	2	3	4	5	7			■	10
A27181780601501	SLTR 178 BASE-X	ZK 60	178	22,23	8.500	1	2	3	4	5	7			■	10
A27181780801501	SLTR 178 BASE-X	ZK 80	178	22,23	8.500	1	2	3	4	5	7			■	10
A27181781201501	SLTR 178 BASE-X	ZK 120	178	22,23	8.500	1	2	3	4	5	7			■	10

Grinding, Polishing (flexible)

SLTB – The robust one with steel backing

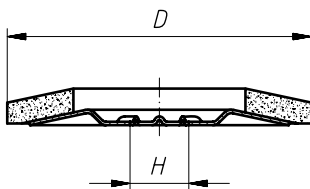

Ordering example: A2250115030

vmax: 80 m/s

ISO 15635

ZK = Zirconia Alum. Oxide

NK = reg. Aluminium Oxide

SLTB = dished

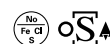
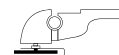

PG 6

Product number	Description	Grit	D mm	H mm	n max. (1/min)	recommended for Information on page 438		
A2250115030	SLTB 115	ZK 36	115	22,23	13.300	① ② ③ ④ ⑤ ⑦	■	10
A2250115040	SLTB 115	ZK 40	115	22,23	13.300	① ② ③ ④ ⑤ ⑦	■	10
A2250115050	SLTB 115	ZK 50	115	22,23	13.300	① ② ③ ④ ⑤ ⑦	■	10
A2250115060	SLTB 115	ZK 60	115	22,23	13.300	① ② ③ ④ ⑤ ⑦	■	10
A2250115080	SLTB 115	ZK 80	115	22,23	13.300	① ② ③ ④ ⑤ ⑦	■	10
A2250115120	SLTB 115	NK 120	115	22,23	13.300	① ② ③ ④ ⑤ ⑥ ⑦ ⑧	■	10
A2250125040	SLTB 125	ZK 40	125	22,23	12.200	① ② ③ ④ ⑤ ⑦	■	10
A2250125060	SLTB 125	ZK 60	125	22,23	12.200	① ② ③ ④ ⑤ ⑦	■	10
A2250125080	SLTB 125	ZK 80	125	22,23	12.200	① ② ③ ④ ⑤ ⑦	■	10
A2250178040	SLTB 178	ZK 40	178	22,23	8.500	① ② ③ ④ ⑤ ⑦	■	10
A2250178060	SLTB 178	ZK 60	178	22,23	8.500	① ② ③ ④ ⑤ ⑦	■	10
A2250178080	SLTB 178	ZK 80	178	22,23	8.500	① ② ③ ④ ⑤ ⑦	■	10

Grinding, Polishing (flexible)

SLTK, made of plastic with space for cooling

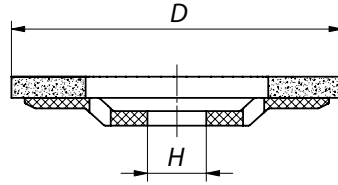

Ordering example: A27111150401623

$v_{max.}$: 80 m/s

ISO 15635

ZK = Abrasive cloth with Zirconia

Alum. Oxide

SLTK = flat

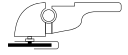

PG 6

Product number	Description	Grit	D mm	H mm	n max. (1/min)	recommended for Information on page 438		
A27111150401623	SLTK 115	ZK 40	115	22,23	13.300	1 2 3 4 5 7	■	10
A27111150601623	SLTK 115	ZK 60	115	22,23	13.300	1 2 3 4 5 7	■	10
A27111250401623	SLTK 125	ZK 40	125	22,23	12.200	1 2 3 4 5 7	■	10
A27111250601623	SLTK 125	ZK 60	125	22,23	12.200	1 2 3 4 5 7	■	10

- the plastic carrier will not leave any abrasive wear on the workpiece.
- now with integrated cooling slots

Grinding, Polishing
(flexible)

SLTK with cooling and quick-release screw thread

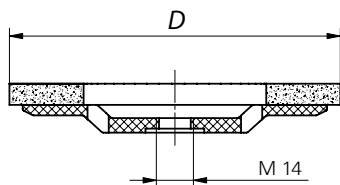

Ordering example: A27111150401723

v_{max.}: 80 m/s

ISO 15635

ZK = Abrasive cloth with Zirconia

Alum. Oxide

SLTK = flat

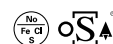
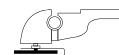

PG 6

Product number	Description	Grit	D mm	Thread	n max. (1/min)	recommended for	Information on page 438		
A27111150401723	SLTK 115	ZK 40	115	M14	13.300	1 2 3 4 5 7		■	10
A27111150601723	SLTK 115	ZK 60	115	M14	13.300	1 2 3 4 5 7		■	10
A27111250401723	SLTK 125	ZK 40	125	M14	12.200	1 2 3 4 5 7		■	10
A27111250601723	SLTK 125	ZK 60	125	M14	12.200	1 2 3 4 5 7		■	10

- the plastic carrier will not leave any abrasive wear on the workpiece
- with M14 screw thread for simple mounting onto the angle grinder
- now with integrated cooling slots

Grinding, Polishing (flexible)

The NAWAROFLEX® with the backing plate made of renewable raw materials

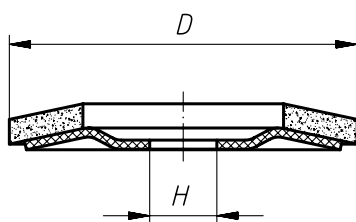

Ordering example: A27031150360127

v_{max.}: 80 m/s

ISO 15635

ZKS = Zirconia Alum. Oxide with special coating containing active grinding additives

SLTC = dishd

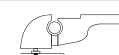

PG 6

Product number	Description	Grit	D mm	H mm	n max (1/min)	recommended for	Information on page 438		
A27031150360127	SLTC 115	ZKS 36	115	22,23	13.300	2 3 4 5 7		■	10
A27031150400127	SLTC 115	ZKS 40	115	22,23	13.300	2 3 4 5 7		■	10
A27031150500127	SLTC 115	ZKS 50	115	22,23	13.300	2 3 4 5 7		■	10
A27031150600127	SLTC 115	ZKS 60	115	22,23	13.300	2 3 4 5 7		■	10
A27031150800127	SLTC 115	ZKS 80	115	22,23	13.300	2 3 4 5 7		■	10
A27031250400127	SLTC 125	ZKS 40	125	22,23	12.200	2 3 4 5 7		■	10
A27031250600127	SLTC 125	ZKS 60	125	22,23	12.200	2 3 4 5 7		■	10
A27031250800127	SLTC 125	ZKS 80	125	22,23	12.200	2 3 4 5 7		■	10

- type with special zirconia alum. oxide material (polyester based) and a coating of active grinding additives
- ideally suited for stainless steel

The NAWAROFLEX® – to improve surface finish

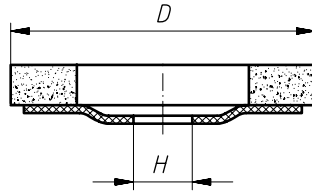

Ordering example: A27131151040140

$v_{max.}$: 32 m/s

ISO 15635

SLTM = flat

A = Abrasive fleece/abrasive cloth combined Al.-Oxide

C = Abrasive fleece/abrasive cloth combined Sil.-Carbide

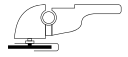

PG 6

Product number	Description	Grit	D mm	H mm	n max. (1/min)	recommended for Information on page 438		
A27131151040140	SLTM 115	A 104/80	115	22,23	5.350	① ② ③ ④ ⑤ ⑥ ⑦ ⑧	■	10
A27131151060140	SLTM 115	A 106/150	115	22,23	5.350	① ② ③ ④ ⑤ ⑥ ⑦ ⑧	■	10
A27131151070140	SLTM 115	A 107/240	115	22,23	5.350	① ② ③ ④ ⑤ ⑥ ⑦ ⑧	■	10
A27131152040141	SLTM 115	C 204/80	115	22,23	5.350	① ② ③ ④ ⑤ ⑥ ⑦ ⑧ ⑨	■	10
A27131152060141	SLTM 115	C 206/150	115	22,23	5.350	① ② ③ ④ ⑤ ⑥ ⑦ ⑧ ⑨	■	10
A27131152070141	SLTM 115	C 207/240	115	22,23	5.350	① ② ③ ④ ⑤ ⑥ ⑦ ⑧ ⑨	■	10

• usable without supporting-plate on adjustable and slow-speed angle grinders

Grinding, Polishing
(flexible)

The NAWAROFLEX® – for finishing and polishing

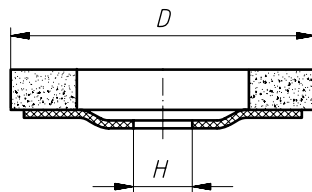

Ordering example: A27221151040130

$v_{max.}$: 32 m/s

SLTV = flat

A = Abrasive fleece/Al.-Oxide

C = Abrasive fleece/Sil.-Carbide

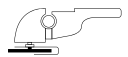

PG 6

Product number	Description	Grit	D mm	H mm	n max. (1/min)	recommended for Information on page 438		
A27221151040130	SLTV 115	A 104	115	22,23	5.350	① ② ③ ④ ⑤ ⑥ ⑦ ⑧	■	10
A27221151060130	SLTV 115	A 106	115	22,23	5.350	① ② ③ ④ ⑤ ⑥ ⑦ ⑧	■	10
A27221151070130	SLTV 115	A 107	115	22,23	5.350	① ② ③ ④ ⑤ ⑥ ⑦ ⑧	■	10
A27221152060130	SLTV 115	C 206	115	22,23	5.350	① ② ③ ④ ⑤ ⑥ ⑦ ⑧ ⑨	■	10
A27221152070130	SLTV 115	C 207	115	22,23	5.350	① ② ③ ④ ⑤ ⑥ ⑦ ⑧ ⑨	■	10

• usable without supporting-plate on adjustable and slow-speed angle grinders

SLTP, Polishing disc

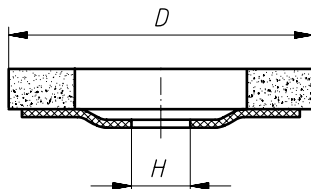
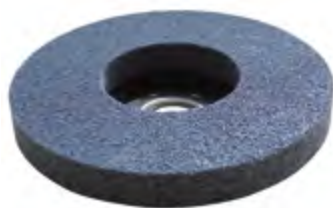

Ordering example: A271611513

$v_{max.}$: 50 m/s

SLTP = flat

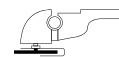

PG 6

Product number	Description	D mm	B mm	reinforced hardness	n max. (1/min)	recommended for Information on page 438		
A271611523	SLTP 115 M	115	22,23	medium	8.350	1 2 3 4 5 6 7 8	■	5
A271611513	SLTP 115 W	115	22,23	soft	8.350	1 2 3 4 5 6 7 8	■	5

Ideal for working on stainless steel, aluminium and other non ferrous metals. With the SLTP deburring, cleaning and polishing applications could be accomplished. The fleece fibre construction avoids the clogging of this tool. The high tool life and the less edge abrasion enhance the efficiency. Usable without supporting-plate on adjustable and slow-speed angle grinders.

Range of application:

- easy deburring
- cleaning of Inox welds
- improving of surfaces

Benefits:

- cool finish on stainless steels
- rebust on edges
- very efficient

Grinding, Polishing (flexible)

Set Polishing discs P6 PT

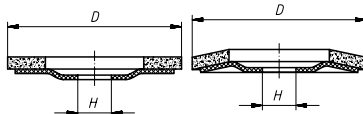

Ordering example: A6700023

$v_{max.}$: 32 m/s

SIC = Silicon carbide

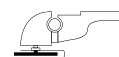

PG 4

Product number	Description	Quality	D mm	Contents	1 piece each	recommended for Information on page 438		
A6700023	P6PT 125 (flat) Set	P6PT	125	4 -pieces	150, 240, 400, 800	1 2 3 4 5 6 7	■	1
A6700024	P6PT 125 (dished) Set	P6PT	125	4 -pieces	150, 240, 400, 800	1 2 3 4 5 6 7	■	1

Create extremely smooth surfaces – right up to mirror finish – very quickly on large surfaces.

Range of application:

- polishing of different surfaces
- cleaning and derusting
- removing paint and coatings
- replaces cloth discs, felt discs and polishing pastes

Benefits:

- for standard controlled angle grinders
- clean working conditions, as no abrasive paste is required
- rapid work progress

Polishing discs P6PT

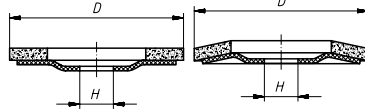

Ordering example: A671612515014

vmax: 32 m/s

SIC = Silicon carbide

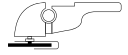

PG 4

Product number	Description	Quality	D mm	reinforced hardness	recommended for							Information on page 438	5
					1	2	3	4	5	6	7		
A671612515014	P6PT 125 (flat)	SC 150 MP	125	medium	1	2	3	4	5	6	7	■	5
A671612515014001	P6PT 125 (flat)	SC 150 MWP	125	medium	1	2	3	4	5	6	7	■	5
A671612524014	P6PT 125 (flat)	SC 240 MWP	125	fine	1	2	3	4	5	6	7	■	5
A671612540014	P6PT 125 (flat)	SC 400 WP	125	very fine	1	2	3	4	5	6	7	■	5
A671612580014	P6PT 125 (flat)	SC 800 WP	125	ultra fine	1	2	3	4	5	6	7	■	5
A671712515014	P6PT 125 (dished)	SC 150 MP	125	medium	1	2	3	4	5	6	7	■	5
A671712524014	P6PT 125 (dished)	SC 240 MWP	125	fine	1	2	3	4	5	6	7	■	5
A671712540014	P6PT 125 (dished)	SC 400 WP	125	very fine	1	2	3	4	5	6	7	■	5
A671712580014	P6PT 125 (dished)	SC 800 WP	125	ultra fine	1	2	3	4	5	6	7	■	5
A6717125120014	P6PT 125 (dished)	SC 1200 WP	125	ultra fine	1	2	3	4	5	6	7	■	5

Create extremely smooth surfaces – right up to mirror finish – very quickly on large surfaces.

Range of application:

- polishing of different surfaces
- cleaning and derusting
- removing paint and coatings
- replaces cloth discs, felt discs and polishing pastes

Benefits:

- for standard controlled angle grinders
- clean working conditions, as no abrasive paste is required
- rapid work progress)

Grinding, Polishing (flexible)

Polishing discs P6PT Quality CG

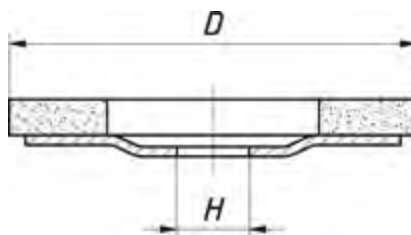

Ordering example: A671611506014

vmax: 80 m/s

EKW = Aluminium oxide white

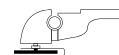

PG 4

Product number	Description	Quality	D mm	B mm	n max. (1/min)	recommended for						Information on page 438	Icon		
						1	2	3	4	5	6				
A671611506014	P6PT 115 (flat)	EKW 60 SHP CG	115	22,23	13.300	1	2	3	4	5	6			■	5
A671611512014	P6PT 115 (flat)	EKW 120 SHP CG	115	22,23	13.300	1	2	3	4	5	6			■	5
A671612506014	P6PT 125 (flat)	EKW 60 SHP CG	125	22,23	12.200	1	2	3	4	5	6			■	5
A671612512014	P6PT 125 (flat)	EKW 120 SHP CG	125	22,23	12.200	1	2	3	4	5	6			■	5

With the new tools of the P6 Compact Grain series you can remove unevenness and scratches on workpieces and they produce a good surface at the same time. This saves time and disturbing tool changes. Thanks to the very strong PU-bond and the Compact-Grain-Technologie, you achieve an enormous tool life. P6 CG tools are ideal as preliminary stage

Ideal for

- cleaning surfaces
- removing scratches
- removing paint and underbody protection
- preparing surfaces for polishing

Characteristics:

- Very hard PU-bond
- Compains contact grain (CG)

Advantages:

- Works on a wide variety of materials
- Can eliminate flaws and unevenness before polishing
- Creates good surfaces
- Enormous tool-life

Grinding. Polishing (flexible)

SLTG, Lamellar Flap Discs quicke-change type

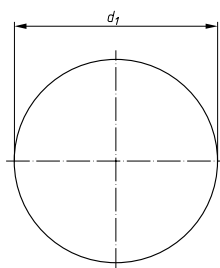

Ordering example: A33310500401623

v_{max.}: 50 m/s

ZK = Zirconia Alum. Oxide

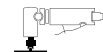

PG 8

Product number	Description	Grit	d ₁ mm	n max. (1/min)	Suitable carriers	recommended for Information on page 438			
A33310500401623	SLTG 050 R	ZK 40	50	19.000	GTR 038.06	1 2 3 4 5 7	■	10	
A33310500601623	SLTG 050 R	ZK 60	50	19.000	GTR 038.06	1 2 3 4 5 7	■	10	
A33310500801623	SLTG 050 R	ZK 80	50	19.000	GTR 038.06	1 2 3 4 5 7	■	10	
A33310501201623	SLTG 050 R	ZK 120	50	19.000	GTR 038.06	1 2 3 4 5 7	■	10	
A33310650401623	SLTG 065 R	ZK 40	65	14.700	GTR 050.06	1 2 3 4 5 7	■	10	
A33310650601623	SLTG 065 R	ZK 60	65	14.700	GTR 050.06	1 2 3 4 5 7	■	10	
A33310650801623	SLTG 065 R	ZK 80	65	14.700	GTR 050.06	1 2 3 4 5 7	■	10	
A33310750401623	SLTG 075 R	ZK 40	75	12.700	GTR 050.06	1 2 3 4 5 7	■	10	
A33310750601623	SLTG 075 R	ZK 60	75	12.700	GTR 050.06	1 2 3 4 5 7	■	10	
A33310750801623	SLTG 075 R	ZK 80	75	12.700	GTR 050.06	1 2 3 4 5 7	■	10	
A33310751201623	SLTG 075 R	ZK 120	75	12.700	GTR 050.06	1 2 3 4 5 7	■	10	

Properties:

- excellent cutting action
- aggressive, even with minimum grinding pressure
- long tool life (compared to fibre discs)
- lamellar projection
- flexible

Application:

- deburring
- fettling
- rust removal
- finishing
- cleaning of weld seams

Grinding, Polishing
(flexible)

GTR, Mandrels for quick-change abrasive discs and SLTG with plastic thread

★★☆

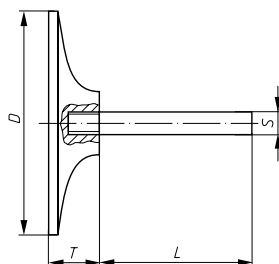

Ordering example: A33600380026

n_{max} : please also refer to flap disc SLTG, page 232



PG 8

Product number	Description	D mm	S mm	Type	n max. (1/min)	recommended for	Information on page 438		
A33600380026	GTR 038.06	33	6	medium	25.000				■ 1
A33600500026	GTR 050.06	45	6	medium	25.000				■ 1
A33600750026	GTR 075.06	70	6	medium	20.000				■ 1

The mandrels are supplied with a hardness for universal application; our **medium** type is suitable for nearly all applications.

The stated maximum operating speed is calculated using the maximum mandrel diameter and maximum overhang L_0 of 5 mm. For other overhangs and smaller mandrel diameters, the maximum operating speed must be re-calculated.

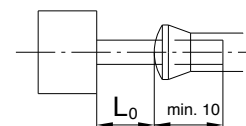

Grinding, Polishing (flexible)

Mounted flap wheels of abrasive cloth

196	Qualities and Applications
236	General Information
236	Mounted flap wheels of abrasive cloth, recessed
237	Mounted flap wheels of abrasive cloth – Ceramic
238	Mounted flap wheels of abrasive cloth
246	Mounted flap wheels of abrasive cloth, slotted
247	Mounted flap wheels of abrasive cloth, SFE
248	Mounted flap wheels of abrasive cloth, SFC
248	Mounted flap wheels with internal thread, SFI
249	Mounted flap wheels with threaded shank, SFA
250	Mini-Flap wheels of abrasive cloth, MFS

Product line marking

The product lines are illustrated by star symbols at the top of the table; please refer to page **14** and **15**.

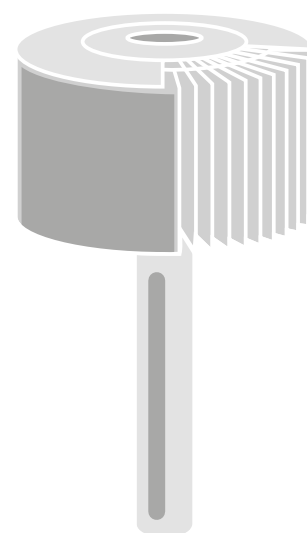

Grinding, Polishing
(flexible)



Information

SFL, mounted flap wheels of abrasive cloth

These tools consist of individual flaps radially located around the hub of the tool; they are mainly used in hand-held power tools. We offer our coated abrasive flap wheels in various qualities i.e. Ceramic, NK, NKE and SIC.

Examples of application:

- finishing
- derusting
- fettling
- deburring
- surface grinding
- decorative finishing
- bevelling

SFB, Mounted flap wheels of abrasive cloth, slotted

By slotting the lamellas on the periphery, the flexibility of this type of mounted flap wheel is increased. The slotted flap wheel quickly profiles itself to the contour of the workpiece.

SFT, Mounted flap wheels of abrasive cloth, recessed

These tools are suitable for face and peripheral grinding.

Adaptor for SFI and SFA

These adaptors extend the shank length and optimise down-time. Tool change is made without removing the adaptor from the machine.

Schleifen, Polieren (flexibel)

SFT, Flap wheels – recessed

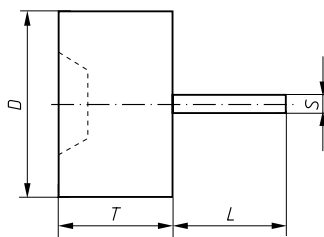

Ordering example: A3100040306060

Further dimensions, qualities and shank lengths on request
NK = reg. Aluminium Oxide

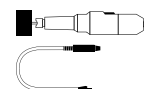

PG 14

Product number	Description	Grit	D mm	T mm	S mm	L mm	n recom. (1/min)	n max. (1/min)	recommended for Information on page 438		
A3100040306060	SFT 04030.06	NK 60	40	30	6	40	12.000	19.100	① ② ③ ④ ⑤ ⑥ ⑦ ⑧	■	10
A3100040306080	SFT 04030.06	NK 80	40	30	6	40	12.000	19.100	① ② ③ ④ ⑤ ⑥ ⑦ ⑧	■	10
A3100040306150	SFT 04030.06	NK 150	40	30	6	40	12.000	19.100	① ② ③ ④ ⑤ ⑥ ⑦ ⑧	■	10
A3100060406060	SFT 06040.06	NK 60	60	40	6	40	8.000	12.700	① ② ③ ④ ⑤ ⑥ ⑦ ⑧	■	10
A3100060406080	SFT 06040.06	NK 80	60	40	6	40	8.000	12.700	① ② ③ ④ ⑤ ⑥ ⑦ ⑧	■	10
A3100060406150	SFT 06040.06	NK 150	60	40	6	40	8.000	12.700	① ② ③ ④ ⑤ ⑥ ⑦ ⑧	■	10

The stated maximum operating speed only applies to a maximum overhang L_0 of 20 mm.

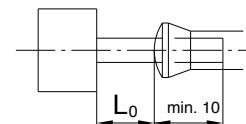

SFL, Flap wheels Ceramic



★★★

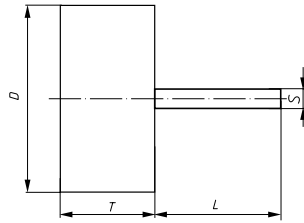
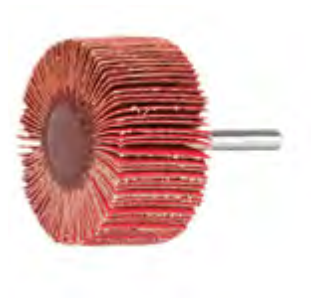

Ordering example: A2214020206060

Ceramic = ceramic grain

Further dimensions and shank lengths on request

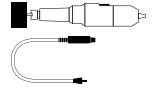

PG 14

Product number	Description	Grit	D mm	T mm	S mm	L mm	n recom. (1/min)	n max. (1/min)	recommended for							Information on page 438	Image icon	
									1	2	3	4	5	6	7			
A2214020206080	SFL 02020	Ceramic 80	20	20	6	40	20.000	38.200	1	2	3	4	5	6	7		■	10
A2214020206120	SFL 02020	Ceramic 120	20	20	6	40	20.000	38.200	1	2	3	4	5	6	7		■	10
A2214030106060	SFL 03010	Ceramic 60	30	10	6	40	16.000	25.400	1	2	3	4	5	6	7		■	10
A2214030106080	SFL 03010	Ceramic 80	30	10	6	40	16.000	25.400	1	2	3	4	5	6	7		■	10
A2214030106120	SFL 03010	Ceramic 120	30	10	6	40	16.000	25.400	1	2	3	4	5	6	7		■	10
A2214040206060	SFL 04020	Ceramic 60	40	20	6	40	12.000	19.100	1	2	3	4	5	6	7		■	10
A2214040206080	SFL 04020	Ceramic 80	40	20	6	40	12.000	19.100	1	2	3	4	5	6	7		■	10
A2214040206120	SFL 04020	Ceramic 120	40	20	6	40	12.000	19.100	1	2	3	4	5	6	7		■	10
A2214060156080	SFL 06015	Ceramic 80	60	15	6	40	8.000	12.700	1	2	3	4	5	6	7		■	10
A2214060156120	SFL 06015	Ceramic 120	60	15	6	40	8.000	12.700	1	2	3	4	5	6	7		■	10
A2214060306060	SFL 06030	Ceramic 60	60	30	6	40	8.000	12.700	1	2	3	4	5	6	7		■	10
A2214060306080	SFL 06030	Ceramic 80	60	30	6	40	8.000	12.700	1	2	3	4	5	6	7		■	10
A2214060306120	SFL 06030	Ceramic 120	60	30	6	40	8.000	12.700	1	2	3	4	5	6	7		■	10

Benefits:

- particularly high stock remove thanks to the self-sharpening ceramic grain
- long service life, thanks to robust design

The stated maximum operating speed only applies to a maximum overhang L_0 of 20 mm

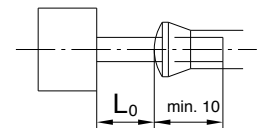

Grinding, Polishing (flexible)

SFL, Flap wheels

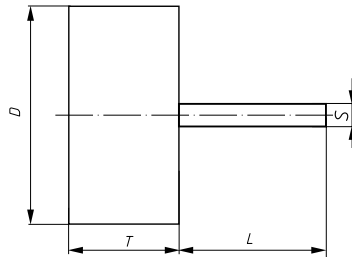

Ordering example: A2200010103080

Further dimensions, qualities and shank lengths on request

NK = reg. Aluminium Oxide

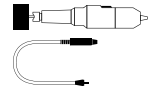

PG 14

Product number	Description	Grit	D mm	T mm	S mm	L mm	n recom. (1/min)	n max. (1/min)	recommended for Information on page 438		
A2200010103080	SFL 01010.03	NK 80	10	10	3	40	26.000	35.000	① ② ③ ④ ⑤ ⑥ ⑦ ⑧	■	10
A2200010103120	SFL 01010.03	NK 120	10	10	3	40	26.000	35.000	① ② ③ ④ ⑤ ⑥ ⑦ ⑧	■	10
A2200010103150	SFL 01010.03	NK 150	10	10	3	40	26.000	35.000	① ② ③ ④ ⑤ ⑥ ⑦ ⑧	■	10
A2200010103240	SFL 01010.03	NK 240	10	10	3	40	26.000	35.000	① ② ③ ④ ⑤ ⑥ ⑦ ⑧	■	10
A2200010153080	SFL 01015.03	NK 80	10	15	3	40	24.000	35.000	① ② ③ ④ ⑤ ⑥ ⑦ ⑧	■	10
A2200015103080	SFL 01510.03	NK 80	15	10	3	40	24.000	35.000	① ② ③ ④ ⑤ ⑥ ⑦ ⑧	■	10
A2200015103150	SFL 01510.03	NK 150	15	10	3	40	24.000	35.000	① ② ③ ④ ⑤ ⑥ ⑦ ⑧	■	10
A2200015106080	SFL 01510.06	NK 80	15	10	6	40	24.000	35.000	① ② ③ ④ ⑤ ⑥ ⑦ ⑧	■	10
A2200015153080	SFL 01515.03	NK 80	15	15	3	40	24.000	35.000	① ② ③ ④ ⑤ ⑥ ⑦ ⑧	■	10
A2200015153120	SFL 01515.03	NK 120	15	15	3	40	24.000	35.000	① ② ③ ④ ⑤ ⑥ ⑦ ⑧	■	10
A2200015153150	SFL 01515.03	NK 150	15	15	3	40	24.000	35.000	① ② ③ ④ ⑤ ⑥ ⑦ ⑧	■	10
A2200020056120	SFL 02005.06	NK 120	20	5	6	40	20.000	38.200	① ② ③ ④ ⑤ ⑥ ⑦ ⑧	■	10
A2200020103080	SFL 02010.03	NK 80	20	10	3	40	20.000	28.000	① ② ③ ④ ⑤ ⑥ ⑦ ⑧	■	10
A2200020103120	SFL 02010.03	NK 120	20	10	3	40	20.000	28.000	① ② ③ ④ ⑤ ⑥ ⑦ ⑧	■	10
A2200020103150	SFL 02010.03	NK 150	20	10	3	40	20.000	28.000	① ② ③ ④ ⑤ ⑥ ⑦ ⑧	■	10
A2200020103320	SFL 02010.03	NK 320	20	10	3	40	20.000	28.000	① ② ③ ④ ⑤ ⑥ ⑦ ⑧	■	10
A2200020106080	SFL 02010.06	NK 80	20	10	6	40	20.000	38.200	① ② ③ ④ ⑤ ⑥ ⑦ ⑧	■	10
A2200020106120	SFL 02010.06	NK 120	20	10	6	40	20.000	38.200	① ② ③ ④ ⑤ ⑥ ⑦ ⑧	■	10
A2200020156060	SFL 02015.06	NK 60	20	15	6	40	20.000	38.200	① ② ③ ④ ⑤ ⑥ ⑦ ⑧	■	10
A2200020156080	SFL 02015.06	NK 80	20	15	6	40	20.000	38.200	① ② ③ ④ ⑤ ⑥ ⑦ ⑧	■	10
A2200020156120	SFL 02015.06	NK 120	20	15	6	40	20.000	38.200	① ② ③ ④ ⑤ ⑥ ⑦ ⑧	■	10
A2200020156150	SFL 02015.06	NK 150	20	15	6	40	20.000	38.200	① ② ③ ④ ⑤ ⑥ ⑦ ⑧	■	10
A2200020156240	SFL 02015.06	NK 240	20	15	6	40	20.000	38.200	① ② ③ ④ ⑤ ⑥ ⑦ ⑧	■	10
A2200020206060	SFL 02020.06	NK 60	20	20	6	40	20.000	38.200	① ② ③ ④ ⑤ ⑥ ⑦ ⑧	■	10
A2200020206080	SFL 02020.06	NK 80	20	20	6	40	20.000	38.200	① ② ③ ④ ⑤ ⑥ ⑦ ⑧	■	10
A2200025053120	SFL 02505.03	NK 120	25	5	3	40	16.000	18.000	① ② ③ ④ ⑤ ⑥ ⑦ ⑧	■	10
A2200025103080	SFL 02510.03	NK 80	25	10	3	40	16.000	18.000	① ② ③ ④ ⑤ ⑥ ⑦ ⑧	■	10
A2200025103120	SFL 02510.03	NK 120	25	10	3	40	16.000	18.000	① ② ③ ④ ⑤ ⑥ ⑦ ⑧	■	10
A2200025103150	SFL 02510.03	NK 150	25	10	3	40	16.000	18.000	① ② ③ ④ ⑤ ⑥ ⑦ ⑧	■	10
A2200025106080	SFL 02510.06	NK 80	25	10	6	40	16.000	30.600	① ② ③ ④ ⑤ ⑥ ⑦ ⑧	■	10
A2200025106120	SFL 02510.06	NK 120	25	10	6	40	16.000	30.600	① ② ③ ④ ⑤ ⑥ ⑦ ⑧	■	10
A2200025156080	SFL 02515.06	NK 80	25	15	6	40	16.000	30.600	① ② ③ ④ ⑤ ⑥ ⑦ ⑧	■	10
A2200025156120	SFL 02515.06	NK 120	25	15	6	40	16.000	30.600	① ② ③ ④ ⑤ ⑥ ⑦ ⑧	■	10

The stated maximum operating speed only applies to a maximum overhang L₀ of 20 mm.

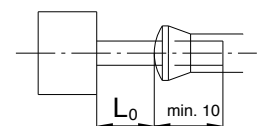

SFL, Flap wheels

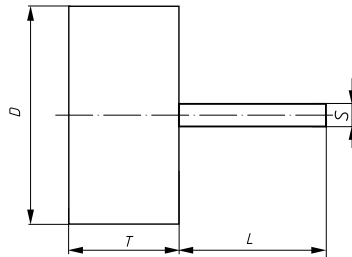

Ordering example: A2200010103080

Further dimensions, qualities and shank lengths on request

NK = reg. Aluminium Oxide

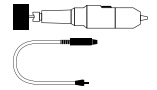

PG 14

Product number	Description	Grit	D mm	T mm	S mm	L mm	n recom. (1/min)	n max. (1/min)	recommended for Information on page 438		
A2200025156150	SFL 02515.06	NK 150	25	15	6	40	16.000	30.600	① ② ③ ④ ⑤ ⑥ ⑦ ⑧	■	10
A2200025206080	SFL 02520.06	NK 80	25	20	6	40	16.000	30.600	① ② ③ ④ ⑤ ⑥ ⑦ ⑧	■	10
A2200025206120	SFL 02520.06	NK 120	25	20	6	40	16.000	30.600	① ② ③ ④ ⑤ ⑥ ⑦ ⑧	■	10
A2200025256080	SFL 02525.06	NK 80	25	25	6	40	16.000	30.600	① ② ③ ④ ⑤ ⑥ ⑦ ⑧	■	10
A2200025256150	SFL 02525.06	NK 150	25	25	6	40	16.000	30.600	① ② ③ ④ ⑤ ⑥ ⑦ ⑧	■	10
A2200030053060	SFL 03005.03	NK 60	30	5	3	40	16.000	18.000	① ② ③ ④ ⑤ ⑥ ⑦ ⑧	■	10
A2200030053080	SFL 03005.03	NK 80	30	5	3	40	16.000	18.000	① ② ③ ④ ⑤ ⑥ ⑦ ⑧	■	10
A2200030053120	SFL 03005.03	NK 120	30	5	3	40	16.000	18.000	① ② ③ ④ ⑤ ⑥ ⑦ ⑧	■	10
A2200030053150	SFL 03005.03	NK 150	30	5	3	40	16.000	18.000	① ② ③ ④ ⑤ ⑥ ⑦ ⑧	■	10
A2200030053240	SFL 03005.03	NK 240	30	5	3	40	16.000	18.000	① ② ③ ④ ⑤ ⑥ ⑦ ⑧	■	10
A2200030053320	SFL 03005.03	NK 320	30	5	3	40	16.000	18.000	① ② ③ ④ ⑤ ⑥ ⑦ ⑧	■	10
A2200030056060	SFL 03005.06	NK 60	30	5	6	40	16.000	25.400	① ② ③ ④ ⑤ ⑥ ⑦ ⑧	■	10
A2200030056080	SFL 03005.06	NK 80	30	5	6	40	16.000	25.400	① ② ③ ④ ⑤ ⑥ ⑦ ⑧	■	10
A2200030056100	SFL 03005.06	NK 100	30	5	6	40	16.000	25.400	① ② ③ ④ ⑤ ⑥ ⑦ ⑧	■	10
A2200030056120	SFL 03005.06	NK 120	30	5	6	40	16.000	25.400	① ② ③ ④ ⑤ ⑥ ⑦ ⑧	■	10
A2200030056150	SFL 03005.06	NK 150	30	5	6	40	16.000	25.400	① ② ③ ④ ⑤ ⑥ ⑦ ⑧	■	10
A2200030056180	SFL 03005.06	NK 180	30	5	6	40	16.000	25.400	① ② ③ ④ ⑤ ⑥ ⑦ ⑧	■	10
A2200030056240	SFL 03005.06	NK 240	30	5	6	40	16.000	25.400	① ② ③ ④ ⑤ ⑥ ⑦ ⑧	■	10
A2200030056320	SFL 03005.06	NK 320	30	5	6	40	16.000	25.400	① ② ③ ④ ⑤ ⑥ ⑦ ⑧	■	10
A2200030103060	SFL 03010.03	NK 60	30	10	3	40	16.000	18.000	① ② ③ ④ ⑤ ⑥ ⑦ ⑧	■	10
A2200030103080	SFL 03010.03	NK 80	30	10	3	40	16.000	18.000	① ② ③ ④ ⑤ ⑥ ⑦ ⑧	■	10
A2200030103120	SFL 03010.03	NK 120	30	10	3	40	16.000	18.000	① ② ③ ④ ⑤ ⑥ ⑦ ⑧	■	10
A2200030103150	SFL 03010.03	NK 150	30	10	3	40	16.000	18.000	① ② ③ ④ ⑤ ⑥ ⑦ ⑧	■	10
A2200030103240	SFL 03010.03	NK 240	30	10	3	40	16.000	18.000	① ② ③ ④ ⑤ ⑥ ⑦ ⑧	■	10
A2200030103320	SFL 03010.03	NK 320	30	10	3	40	16.000	18.000	① ② ③ ④ ⑤ ⑥ ⑦ ⑧	■	10
A2200030106060	SFL 03010.06	NK 60	30	10	6	40	16.000	25.400	① ② ③ ④ ⑤ ⑥ ⑦ ⑧	■	10
A2200030106080	SFL 03010.06	NK 80	30	10	6	40	16.000	25.400	① ② ③ ④ ⑤ ⑥ ⑦ ⑧	■	10
A2200030106100	SFL 03010.06	NK 100	30	10	6	40	16.000	25.400	① ② ③ ④ ⑤ ⑥ ⑦ ⑧	■	10
A2200030106120	SFL 03010.06	NK 120	30	10	6	40	16.000	25.400	① ② ③ ④ ⑤ ⑥ ⑦ ⑧	■	10
A2200030106150	SFL 03010.06	NK 150	30	10	6	40	16.000	25.400	① ② ③ ④ ⑤ ⑥ ⑦ ⑧	■	10
A2200030106180	SFL 03010.06	NK 180	30	10	6	G	16.000	18.000	③ ④ ⑤ ⑥ ⑦ ⑧	■	10
A2200030106240	SFL 03010.06	NK 240	30	10	6	40	16.000	25.400	① ② ③ ④ ⑤ ⑥ ⑦ ⑧	■	10
A2200030106320	SFL 03010.06	NK 320	30	10	6	40	16.000	25.400	① ② ③ ④ ⑤ ⑥ ⑦ ⑧	■	10

The stated maximum operating speed only applies to a maximum overhang L₀ of 20 mm.

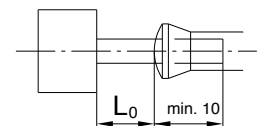

SFL, Flap wheels

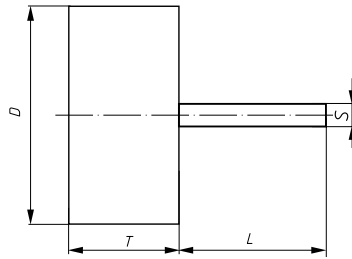

Ordering example: A2200010103080

Further dimensions, qualities and shank lengths on request

NK = reg. Aluminium Oxide

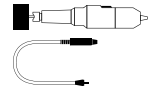

PG 14

Product number	Description	Grit	D mm	T mm	S mm	L mm	n recom. (1/min)	n max. (1/min)	recommended for Information on page 438		
A2200030156060	SFL 03015.06	NK 60	30	15	6	40	16.000	25.400	① ② ③ ④ ⑤ ⑥ ⑦ ⑧	■	10
A2200030156080	SFL 03015.06	NK 80	30	15	6	40	16.000	25.400	① ② ③ ④ ⑤ ⑥ ⑦ ⑧	■	10
A2200030156120	SFL 03015.06	NK 120	30	15	6	40	16.000	25.400	① ② ③ ④ ⑤ ⑥ ⑦ ⑧	■	10
A2200030156150	SFL 03015.06	NK 150	30	15	6	40	16.000	25.400	① ② ③ ④ ⑤ ⑥ ⑦ ⑧	■	10
A2200030156180	SFL 03015.06	NK 180	30	15	6	40	16.000	25.400	① ② ③ ④ ⑤ ⑥ ⑦ ⑧	■	10
A2200030206040	SFL 03020.06	NK 40	30	20	6	40	16.000	25.400	① ② ③ ④ ⑤ ⑥ ⑦ ⑧	■	10
A2200030206060	SFL 03020.06	NK 60	30	20	6	40	16.000	25.400	① ② ③ ④ ⑤ ⑥ ⑦ ⑧	■	10
A2200030206080	SFL 03020.06	NK 80	30	20	6	40	16.000	25.400	① ② ③ ④ ⑤ ⑥ ⑦ ⑧	■	10
A2200030206120	SFL 03020.06	NK 120	30	20	6	40	16.000	25.400	① ② ③ ④ ⑤ ⑥ ⑦ ⑧	■	10
A2200040056100	SFL 04005.06	NK 100	40	5	6	40	12.200	19.100	① ② ③ ④ ⑤ ⑥ ⑦ ⑧	■	10
A2200040103060	SFL 04010.03	NK 60	40	10	3	40	12.000	14.000	① ② ③ ④ ⑤ ⑥ ⑦ ⑧	■	10
A2200040103080	SFL 04010.03	NK 80	40	10	3	40	12.000	14.000	① ② ③ ④ ⑤ ⑥ ⑦ ⑧	■	10
A2200040103120	SFL 04010.03	NK 120	40	10	3	40	12.000	14.000	① ② ③ ④ ⑤ ⑥ ⑦ ⑧	■	10
A2200040103150	SFL 04010.03	NK 150	40	10	3	40	12.000	14.000	① ② ③ ④ ⑤ ⑥ ⑦ ⑧	■	10
A2200040106060	SFL 04010.06	NK 60	40	10	6	40	12.000	19.100	① ② ③ ④ ⑤ ⑥ ⑦ ⑧	■	10
A2200040106080	SFL 04010.06	NK 80	40	10	6	40	12.000	19.100	① ② ③ ④ ⑤ ⑥ ⑦ ⑧	■	10
A2200040106100	SFL 04010.06	NK 100	40	10	6	40	12.200	19.100	① ② ③ ④ ⑤ ⑥ ⑦ ⑧	■	10
A2200040106120	SFL 04010.06	NK 120	40	10	6	40	12.000	19.100	① ② ③ ④ ⑤ ⑥ ⑦ ⑧	■	10
A2200040106150	SFL 04010.06	NK 150	40	10	6	40	12.000	19.100	① ② ③ ④ ⑤ ⑥ ⑦ ⑧	■	10
A2200040106180	SFL 04010.06	NK 180	40	10	6	40	12.000	19.100	① ② ③ ④ ⑤ ⑥ ⑦ ⑧	■	10
A2200040106240	SFL 04010.06	NK 240	40	10	6	40	12.000	19.100	① ② ③ ④ ⑤ ⑥ ⑦ ⑧	■	10
A2200040106320	SFL 04010.06	NK 320	40	10	6	40	12.000	19.100	① ② ③ ④ ⑤ ⑥ ⑦ ⑧	■	10
A2200040156040	SFL 04015.06	NK 40	40	15	6	40	12.000	19.100	① ② ③ ④ ⑤ ⑥ ⑦ ⑧	■	10
A2200040156060	SFL 04015.06	NK 60	40	15	6	40	12.000	19.100	① ② ③ ④ ⑤ ⑥ ⑦ ⑧	■	10
A2200040156080	SFL 04015.06	NK 80	40	15	6	40	12.000	19.100	① ② ③ ④ ⑤ ⑥ ⑦ ⑧	■	10
A2200040156120	SFL 04015.06	NK 120	40	15	6	40	12.000	19.100	① ② ③ ④ ⑤ ⑥ ⑦ ⑧	■	10
A2200040156150	SFL 04015.06	NK 150	40	15	6	40	12.000	19.100	① ② ③ ④ ⑤ ⑥ ⑦ ⑧	■	10
A2200040156240	SFL 04015.06	NK 240	40	15	6	40	12.000	19.100	① ② ③ ④ ⑤ ⑥ ⑦ ⑧	■	10
A2200040156320	SFL 04015.06	NK 320	40	15	6	40	12.000	19.100	① ② ③ ④ ⑤ ⑥ ⑦ ⑧	■	10
A2200040206040	SFL 04020.06	NK 40	40	20	6	40	12.000	19.100	① ② ③ ④ ⑤ ⑥ ⑦ ⑧	■	10
A2200040206060	SFL 04020.06	NK 60	40	20	6	40	12.000	19.100	① ② ③ ④ ⑤ ⑥ ⑦ ⑧	■	10
A2200040206080	SFL 04020.06	NK 80	40	20	6	40	12.000	19.100	① ② ③ ④ ⑤ ⑥ ⑦ ⑧	■	10
A2200040206120	SFL 04020.06	NK 120	40	20	6	40	12.000	19.100	① ② ③ ④ ⑤ ⑥ ⑦ ⑧	■	10

The stated maximum operating speed only applies to a maximum overhang L_0 of 20 mm.

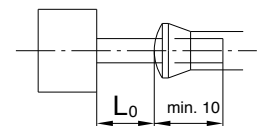

SFL, Flap wheels

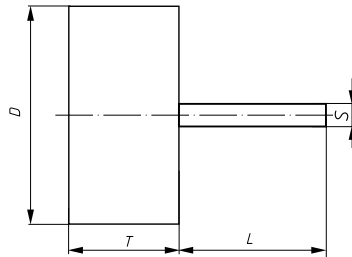

Ordering example: A2200010103080

Further dimensions, qualities and shank lengths on request

NK = reg. Aluminium Oxide

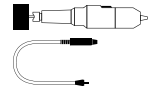

PG 14

Product number	Description	Grit	D mm	T mm	S mm	L mm	n recom. (1/min)	n max. (1/min)	recommended for Information on page 438		
A2200040206150	SFL 04020.06	NK 150	40	20	6	40	12.000	19.100	① ② ③ ④ ⑤ ⑥ ⑦ ⑧	■	10
A2200040206240	SFL 04020.06	NK 240	40	20	6	40	12.000	19.100	① ② ③ ④ ⑤ ⑥ ⑦ ⑧	■	10
A2200040206320	SFL 04020.06	NK 320	40	20	6	40	12.000	19.100	① ② ③ ④ ⑤ ⑥ ⑦ ⑧	■	10
A2200040306040	SFL 04030.06	NK 40	40	30	6	40	12.000	19.100	① ② ③ ④ ⑤ ⑥ ⑦ ⑧	■	10
A2200040306060	SFL 04030.06	NK 60	40	30	6	40	12.000	19.100	① ② ③ ④ ⑤ ⑥ ⑦ ⑧	■	10
A2200040306080	SFL 04030.06	NK 80	40	30	6	40	12.000	19.100	① ② ③ ④ ⑤ ⑥ ⑦ ⑧	■	10
A2200050056100	SFL 05005.06	NK 100	50	5	6	40	9.000	15.300	① ② ③ ④ ⑤ ⑥ ⑦ ⑧	■	10
A2200050106060	SFL 05010.06	NK 60	50	10	6	40	9.000	15.300	① ② ③ ④ ⑤ ⑥ ⑦ ⑧	■	10
A2200050106080	SFL 05010.06	NK 80	50	10	6	40	9.000	15.300	① ② ③ ④ ⑤ ⑥ ⑦ ⑧	■	10
A2200050106100	SFL 05010.06	NK 100	50	10	6	40	9.000	15.300	① ② ③ ④ ⑤ ⑥ ⑦ ⑧	■	10
A2200050106120	SFL 05010.06	NK 120	50	10	6	40	9.000	15.300	① ② ③ ④ ⑤ ⑥ ⑦ ⑧	■	10
A2200050106150	SFL 05010.06	NK 150	50	10	6	40	9.000	15.300	① ② ③ ④ ⑤ ⑥ ⑦ ⑧	■	10
A2200050106180	SFL 05010.06	NK 180	50	10	6	40	9.000	15.300	① ② ③ ④ ⑤ ⑥ ⑦ ⑧	■	10
A2200050106240	SFL 05010.06	NK 240	50	10	6	40	9.000	15.300	① ② ③ ④ ⑤ ⑥ ⑦ ⑧	■	10
A2200050156040	SFL 05015.06	NK 40	50	15	6	40	9.000	15.300	① ② ③ ④ ⑤ ⑥ ⑦ ⑧	■	10
A2200050156060	SFL 05015.06	NK 60	50	15	6	40	9.000	15.300	① ② ③ ④ ⑤ ⑥ ⑦ ⑧	■	10
A2200050156080	SFL 05015.06	NK 80	50	15	6	40	9.000	15.300	① ② ③ ④ ⑤ ⑥ ⑦ ⑧	■	10
A2200050156120	SFL 05015.06	NK 120	50	15	6	40	9.000	15.300	① ② ③ ④ ⑤ ⑥ ⑦ ⑧	■	10
A2200050156150	SFL 05015.06	NK 150	50	15	6	40	9.000	15.300	① ② ③ ④ ⑤ ⑥ ⑦ ⑧	■	10
A2200050156240	SFL 05015.06	NK 240	50	15	6	40	9.000	15.300	① ② ③ ④ ⑤ ⑥ ⑦ ⑧	■	10
A2200050156320	SFL 05015.06	NK 320	50	15	6	40	9.000	15.300	① ② ③ ④ ⑤ ⑥ ⑦ ⑧	■	10
A2200050206040	SFL 05020.06	NK 40	50	20	6	40	9.000	15.300	① ② ③ ④ ⑤ ⑥ ⑦ ⑧	■	10
A2200050206060	SFL 05020.06	NK 60	50	20	6	40	9.000	15.300	① ② ③ ④ ⑤ ⑥ ⑦ ⑧	■	10
A2200050206080	SFL 05020.06	NK 80	50	20	6	40	9.000	15.300	① ② ③ ④ ⑤ ⑥ ⑦ ⑧	■	10
A2200050206120	SFL 05020.06	NK 120	50	20	6	40	9.000	15.300	① ② ③ ④ ⑤ ⑥ ⑦ ⑧	■	10
A2200050206150	SFL 05020.06	NK 150	50	20	6	40	9.000	15.300	① ② ③ ④ ⑤ ⑥ ⑦ ⑧	■	10
A2200050206240	SFL 05020.06	NK 240	50	20	6	40	9.000	15.300	① ② ③ ④ ⑤ ⑥ ⑦ ⑧	■	10
A2200050206320	SFL 05020.06	NK 320	50	20	6	40	9.000	15.300	① ② ③ ④ ⑤ ⑥ ⑦ ⑧	■	10
A2200050306040	SFL 05030.06	NK 40	50	30	6	40	9.000	15.300	① ② ③ ④ ⑤ ⑥ ⑦ ⑧	■	10
A2200050306060	SFL 05030.06	NK 60	50	30	6	40	9.000	15.300	① ② ③ ④ ⑤ ⑥ ⑦ ⑧	■	10
A2200050306080	SFL 05030.06	NK 80	50	30	6	40	9.000	15.300	① ② ③ ④ ⑤ ⑥ ⑦ ⑧	■	10
A2200050306120	SFL 05030.06	NK 120	50	30	6	40	9.000	15.300	① ② ③ ④ ⑤ ⑥ ⑦ ⑧	■	10
A2200050306150	SFL 05030.06	NK 150	50	30	6	40	9.000	15.300	① ② ③ ④ ⑤ ⑥ ⑦ ⑧	■	10

The stated maximum operating speed only applies to a maximum overhang L_0 of 20 mm.

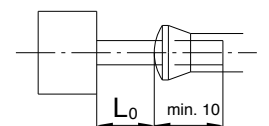

SFL, Flap wheels

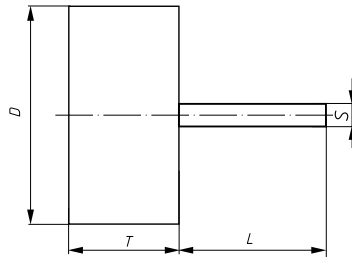

Ordering example: A2200010103080

Further dimensions, qualities and shank lengths on request

NK = reg. Aluminium Oxide

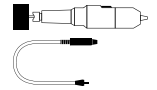

PG 14

Product number	Description	Grit	D mm	T mm	S mm	L mm	n recom. (1/min)	n max. (1/min)	recommended for Information on page 438		
A2200050306320	SFL 05030.06	NK 320	50	30	6	40	9.000	15.300	① ② ③ ④ ⑤ ⑥ ⑦ ⑧	■	10
A2200060106060	SFL 06010.06	NK 60	60	10	6	40	8.000	12.700	① ② ③ ④ ⑤ ⑥ ⑦ ⑧	■	10
A2200060106080	SFL 06010.06	NK 80	60	10	6	40	8.000	12.700	① ② ③ ④ ⑤ ⑥ ⑦ ⑧	■	10
A2200060106100	SFL 06010.06	NK 100	60	10	6	40	8.000	12.700	① ② ③ ④ ⑤ ⑥ ⑦ ⑧	■	10
A2200060156040	SFL 06015.06	NK 40	60	15	6	40	8.000	12.700	① ② ③ ④ ⑤ ⑥ ⑦ ⑧	■	10
A2200060156060	SFL 06015.06	NK 60	60	15	6	40	8.000	12.700	① ② ③ ④ ⑤ ⑥ ⑦ ⑧	■	10
A2200060156080	SFL 06015.06	NK 80	60	15	6	40	8.000	12.700	① ② ③ ④ ⑤ ⑥ ⑦ ⑧	■	10
A2200060156120	SFL 06015.06	NK 120	60	15	6	40	8.000	12.700	① ② ③ ④ ⑤ ⑥ ⑦ ⑧	■	10
A2200060156150	SFL 06015.06	NK 150	60	15	6	40	8.000	12.700	① ② ③ ④ ⑤ ⑥ ⑦ ⑧	■	10
A2200060156240	SFL 06015.06	NK 240	60	15	6	40	8.000	12.700	① ② ③ ④ ⑤ ⑥ ⑦ ⑧	■	10
A2200060156320	SFL 06015.06	NK 320	60	15	6	40	8.000	12.700	① ② ③ ④ ⑤ ⑥ ⑦ ⑧	■	10
A2200060206040	SFL 06020.06	NK 40	60	20	6	40	8.000	12.700	① ② ③ ④ ⑤ ⑥ ⑦ ⑧	■	10
A2200060206060	SFL 06020.06	NK 60	60	20	6	40	8.000	12.700	① ② ③ ④ ⑤ ⑥ ⑦ ⑧	■	10
A2200060206080	SFL 06020.06	NK 80	60	20	6	40	8.000	12.700	① ② ③ ④ ⑤ ⑥ ⑦ ⑧	■	10
A2200060206120	SFL 06020.06	NK 120	60	20	6	40	8.000	12.700	① ② ③ ④ ⑤ ⑥ ⑦ ⑧	■	10
A2200060206150	SFL 06020.06	NK 150	60	20	6	40	8.000	12.700	① ② ③ ④ ⑤ ⑥ ⑦ ⑧	■	10
A2200060206240	SFL 06020.06	NK 240	60	20	6	40	8.000	12.700	① ② ③ ④ ⑤ ⑥ ⑦ ⑧	■	10
A2200060206320	SFL 06020.06	NK 320	60	20	6	40	8.000	12.700	① ② ③ ④ ⑤ ⑥ ⑦ ⑧	■	10
A2200060306040	SFL 06030.06	NK 40	60	30	6	40	8.000	12.700	① ② ③ ④ ⑤ ⑥ ⑦ ⑧	■	10
A2200060306060	SFL 06030.06	NK 60	60	30	6	40	8.000	12.700	① ② ③ ④ ⑤ ⑥ ⑦ ⑧	■	10
A2200060306080	SFL 06030.06	NK 80	60	30	6	40	8.000	12.700	① ② ③ ④ ⑤ ⑥ ⑦ ⑧	■	10
A2200060306100	SFL 06030.06	NK 100	60	30	6	40	8.000	12.700	① ② ③ ④ ⑤ ⑥ ⑦ ⑧	■	10
A2200060306120	SFL 06030.06	NK 120	60	30	6	40	8.000	12.700	① ② ③ ④ ⑤ ⑥ ⑦ ⑧	■	10
A2200060306150	SFL 06030.06	NK 150	60	30	6	40	8.000	12.700	① ② ③ ④ ⑤ ⑥ ⑦ ⑧	■	10
A2200060306240	SFL 06030.06	NK 240	60	30	6	40	8.000	12.700	① ② ③ ④ ⑤ ⑥ ⑦ ⑧	■	10
A2200060306320	SFL 06030.06	NK 320	60	30	6	40	8.000	12.700	① ② ③ ④ ⑤ ⑥ ⑦ ⑧	■	10
A2200060406040	SFL 06040.06	NK 40	60	40	6	40	8.000	12.700	① ② ③ ④ ⑤ ⑥ ⑦ ⑧	■	10
A2200060406060	SFL 06040.06	NK 60	60	40	6	40	8.000	12.700	① ② ③ ④ ⑤ ⑥ ⑦ ⑧	■	10
A2200060406080	SFL 06040.06	NK 80	60	40	6	40	8.000	12.700	① ② ③ ④ ⑤ ⑥ ⑦ ⑧	■	10
A2200060406120	SFL 06040.06	NK 120	60	40	6	40	8.000	12.700	① ② ③ ④ ⑤ ⑥ ⑦ ⑧	■	10
A2200060406150	SFL 06040.06	NK 150	60	40	6	40	8.000	12.700	① ② ③ ④ ⑤ ⑥ ⑦ ⑧	■	10
A2200060406240	SFL 06040.06	NK 240	60	40	6	40	8.000	12.700	① ② ③ ④ ⑤ ⑥ ⑦ ⑧	■	10
A2200060406320	SFL 06040.06	NK 320	60	40	6	40	8.000	12.700	① ② ③ ④ ⑤ ⑥ ⑦ ⑧	■	10

The stated maximum operating speed only applies to a maximum overhang L_0 of 20 mm.

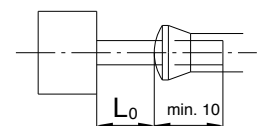

Grinding, Polishing (flexible)

SFL, Flap wheels

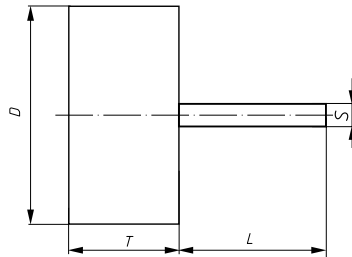

Ordering example: A2200010103080

Further dimensions, qualities and shank lengths on request

NK = reg. Aluminium Oxide

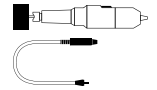

PG 14

Product number	Description	Grit	D mm	T mm	S mm	L mm	n recom. (1/min)	n max. (1/min)	recommended for Information on page 438		
A2200060506040	SFL 06050.06	NK 40	60	50	6	40	8.000	8.500	① ② ③ ④ ⑤ ⑥ ⑦ ⑧	■	10
A2200060506060	SFL 06050.06	NK 60	60	50	6	40	8.000	8.500	① ② ③ ④ ⑤ ⑥ ⑦ ⑧	■	10
A2200060506080	SFL 06050.06	NK 80	60	50	6	40	8.000	8.500	① ② ③ ④ ⑤ ⑥ ⑦ ⑧	■	10
A2200060506120	SFL 06050.06	NK 120	60	50	6	40	8.000	8.500	① ② ③ ④ ⑤ ⑥ ⑦ ⑧	■	10
A2200060506150	SFL 06050.06	NK 150	60	50	6	40	8.000	8.500	① ② ③ ④ ⑤ ⑥ ⑦ ⑧	■	10
A2200060506240	SFL 06050.06	NK 240	60	50	6	40	8.000	8.500	① ② ③ ④ ⑤ ⑥ ⑦ ⑧	■	10
A2200080156060	SFL 08015.06	NK 60	80	15	6	40	6.000	9.500	① ② ③ ④ ⑤ ⑥ ⑦ ⑧	■	10
A2200080156080	SFL 08015.06	NK 80	80	15	6	40	6.000	9.500	① ② ③ ④ ⑤ ⑥ ⑦ ⑧	■	10
A2200080156120	SFL 08015.06	NK 120	80	15	6	40	6.000	9.500	① ② ③ ④ ⑤ ⑥ ⑦ ⑧	■	10
A2200080156150	SFL 08015.06	NK 150	80	15	6	40	6.000	9.500	① ② ③ ④ ⑤ ⑥ ⑦ ⑧	■	10
A2200080156240	SFL 08015.06	NK 240	80	15	6	40	6.000	9.500	① ② ③ ④ ⑤ ⑥ ⑦ ⑧	■	10
A2200080156320	SFL 08015.06	NK 320	80	15	6	40	6.000	9.500	① ② ③ ④ ⑤ ⑥ ⑦ ⑧	■	10
A2200080206060	SFL 08020.06	NK 60	80	20	6	40	6.000	9.500	① ② ③ ④ ⑤ ⑥ ⑦ ⑧	■	10
A2200080206080	SFL 08020.06	NK 80	80	20	6	40	6.000	9.500	① ② ③ ④ ⑤ ⑥ ⑦ ⑧	■	10
A2200080206120	SFL 08020.06	NK 120	80	20	6	40	6.000	9.500	① ② ③ ④ ⑤ ⑥ ⑦ ⑧	■	10
A2200080206150	SFL 08020.06	NK 150	80	20	6	40	6.000	9.500	① ② ③ ④ ⑤ ⑥ ⑦ ⑧	■	10
A2200080306040	SFL 08030.06	NK 40	80	30	6	40	6.000	9.500	① ② ③ ④ ⑤ ⑥ ⑦ ⑧	■	10
A2200080306060	SFL 08030.06	NK 60	80	30	6	40	6.000	9.500	① ② ③ ④ ⑤ ⑥ ⑦ ⑧	■	10
A2200080306080	SFL 08030.06	NK 80	80	30	6	40	6.000	9.500	① ② ③ ④ ⑤ ⑥ ⑦ ⑧	■	10
A2200080306120	SFL 08030.06	NK 120	80	30	6	40	6.000	9.500	① ② ③ ④ ⑤ ⑥ ⑦ ⑧	■	10
A2200080306150	SFL 08030.06	NK 150	80	30	6	40	6.000	9.500	① ② ③ ④ ⑤ ⑥ ⑦ ⑧	■	10
A2200080306320	SFL 08030.06	NK 320	80	30	6	40	6.000	9.500	① ② ③ ④ ⑤ ⑥ ⑦ ⑧	■	10
A2200080406060	SFL 08040.06	NK 60	80	40	6	40	6.000	9.500	① ② ③ ④ ⑤ ⑥ ⑦ ⑧	■	10
A2200080406080	SFL 08040.06	NK 80	80	40	6	40	6.000	9.500	① ② ③ ④ ⑤ ⑥ ⑦ ⑧	■	10
A2200080406150	SFL 08040.06	NK 150	80	40	6	40	6.000	9.500	① ② ③ ④ ⑤ ⑥ ⑦ ⑧	■	10
A2200080506040	SFL 08050.06	NK 40	80	50	6	40	6.000	7.500	① ② ③ ④ ⑤ ⑥ ⑦ ⑧	■	10
A2200080506060	SFL 08050.06	NK 60	80	50	6	40	6.000	7.500	① ② ③ ④ ⑤ ⑥ ⑦ ⑧	■	10
A2200080506080	SFL 08050.06	NK 80	80	50	6	40	6.000	7.500	① ② ③ ④ ⑤ ⑥ ⑦ ⑧	■	10
A2200080506120	SFL 08050.06	NK 120	80	50	6	40	6.000	7.500	① ② ③ ④ ⑤ ⑥ ⑦ ⑧	■	10
A2200080506150	SFL 08050.06	NK 150	80	50	6	40	6.000	7.500	① ② ③ ④ ⑤ ⑥ ⑦ ⑧	■	10
A2200080506240	SFL 08050.06	NK 240	80	50	6	40	6.000	7.500	① ② ③ ④ ⑤ ⑥ ⑦ ⑧	■	10
A2200080506320	SFL 08050.06	NK 320	80	50	6	40	6.000	7.500	① ② ③ ④ ⑤ ⑥ ⑦ ⑧	■	10
A2200100408040	SFL 10040.08	NK 40	100	40	8	40	5.000	7.500	① ② ③ ④ ⑤ ⑥ ⑦ ⑧	■	10

The stated maximum operating speed only applies to a maximum overhang L_0 of 20 mm.

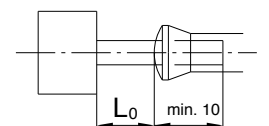

SFL, Flap wheels

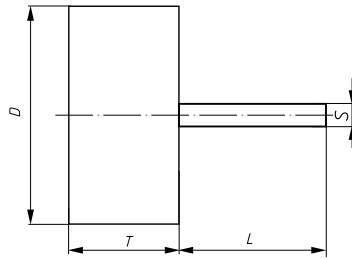

Ordering example: A2200010103080

Further dimensions, qualities and shank lengths on request

NK = reg. Aluminium Oxide

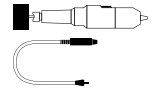

PG 14

Product number	Description	Grit	D mm	T mm	S mm	L mm	n recom. (1/min)	n max. (1/min)	recommended for Information on page 438		
A2200100408060	SFL 10040.08	NK 60	100	40	8	40	5.000	7.500	① ② ③ ④ ⑤ ⑥ ⑦ ⑧	■	10
A2200100508060	SFL 10050.08	NK 60	100	50	8	40	5.000	7.500	① ② ③ ④ ⑤ ⑥ ⑦ ⑧	■	10
A2200100508080	SFL 10050.08	NK 80	100	50	8	40	5.000	7.500	① ② ③ ④ ⑤ ⑥ ⑦ ⑧	■	10
A2200100508150	SFL 10050.08	NK 150	100	50	8	40	5.000	7.500	① ② ③ ④ ⑤ ⑥ ⑦ ⑧	■	10

The stated maximum operating speed only applies to a maximum overhang L_0 of 20 mm.

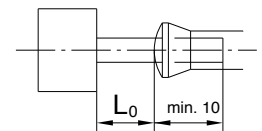

Grinding, Polishing (flexible)

SFL, Flap wheels BASE-X

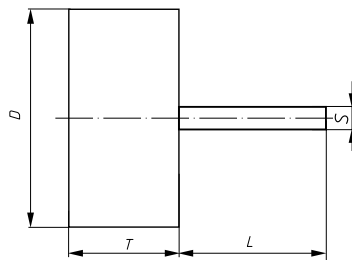

A2230030106060

NK = reg. Aluminium Oxide

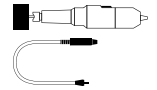

PG 14

Product number	Description	Grit	D mm	T mm	S mm	L mm	n recom. (1/min)	n max. (1/min)	recommended for								Information on page 438	20
									1	2	3	4	5	6	7	8		
A2230030106060	SFL 03010.06	NK 60	30	10	6	40	16.000	18.000	1	2	3	4	5	6	7	8	■	20
A2230030106080	SFL 03010.06	NK 80	30	10	6	40	16.000	18.000	1	2	3	4	5	6	7	8	■	20
A2230030106120	SFL 03010.06	NK 120	30	10	6	40	16.000	18.000	1	2	3	4	5	6	7	8	■	20
A2230030106150	SFL 03010.06	NK 150	30	10	6	40	16.000	18.000	1	2	3	4	5	6	7	8	■	20
A2230040156060	SFL 04015.06	NK 60	40	15	6	40	12.000	19.100	1	2	3	4	5	6	7	8	■	20
A2230040156080	SFL 04015.06	NK 80	40	15	6	40	12.000	19.100	1	2	3	4	5	6	7	8	■	20
A2230040156120	SFL 04015.06	NK 120	40	15	6	40	12.000	19.100	1	2	3	4	5	6	7	8	■	20
A2230040156150	SFL 04015.06	NK 150	40	15	6	40	12.000	19.100	1	2	3	4	5	6	7	8	■	20
A2230040206040	SFL 04020.06	NK 40	40	20	6	40	12.000	19.100	1	2	3	4	5	6	7	8	■	20
A2230040206060	SFL 04020.06	NK 60	40	20	6	40	12.000	19.100	1	2	3	4	5	6	7	8	■	20
A2230050106060	SFL 05010.06	NK 60	50	10	6	40	9.000	15.300	1	2	3	4	5	6	7	8	■	20
A2230050106080	SFL 05010.06	NK 80	50	10	6	40	9.000	15.300	1	2	3	4	5	6	7	8	■	20
A2230050106120	SFL 05010.06	NK 120	50	10	6	40	9.000	15.300	1	2	3	4	5	6	7	8	■	20
A2230050106150	SFL 05010.06	NK 150	50	10	6	40	9.000	15.300	1	2	3	4	5	6	7	8	■	20
A2230050206060	SFL 05020.06	NK 60	50	20	6	40	9.000	15.300	1	2	3	4	5	6	7	8	■	20
A2230050206080	SFL 05020.06	NK 80	50	20	6	40	9.000	15.300	1	2	3	4	5	6	7	8	■	20
A2230060306040	SFL 06030.06	NK 40	60	30	6	40	8.000	12.700	1	2	3	4	5	6	7	8	■	20
A2230060306060	SFL 06030.06	NK 60	60	30	6	40	8.000	12.700	1	2	3	4	5	6	7	8	■	20
A2230060306080	SFL 06030.06	NK 80	60	30	6	40	8.000	12.700	1	2	3	4	5	6	7	8	■	20
A2230060306120	SFL 06030.06	NK 120	60	30	6	40	8.000	12.700	1	2	3	4	5	6	7	8	■	20
A2230060306150	SFL 06030.06	NK 150	60	30	6	40	8.000	12.700	1	2	3	4	5	6	7	8	■	20

The stated maximum operating speed only applies to a maximum overhang L_0 of 20 mm.

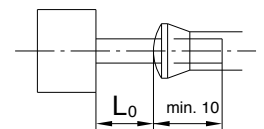

Grinding, Polishing (flexible)

SFB, Slotted flap wheel

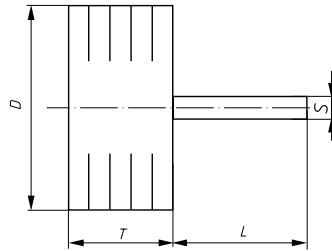

Ordering example: A2220040206080

Further dimensions, qualities and shank lengths on request

NK = reg. Aluminium Oxide

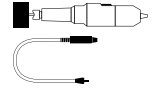

PG 14

Product number	Description	Grit	D mm	T mm	S mm	L mm	n recom. (1/min)	n max. (1/min)	recommended for Information on page 438		
A2220040206080	SFB 04020.06	NK 80	40	20	6	40	12.000	19.100	① ② ③ ④ ⑤ ⑥ ⑦ ⑧	■	10
A2220050206080	SFB 05020.06	NK 80	50	20	6	40	9.000	15.300	① ② ③ ④ ⑤ ⑥ ⑦ ⑧	■	10
A2220050306120	SFB 05030.06	NK 120	50	30	6	40	9.000	15.300	① ② ③ ④ ⑤ ⑥ ⑦ ⑧	■	10
A2220060306080	SFB 06030.06	NK 80	60	30	6	40	8.000	12.700	① ② ③ ④ ⑤ ⑥ ⑦ ⑧	■	10
A2220060306120	SFB 06030.06	NK 120	60	30	6	40	8.000	12.700	① ② ③ ④ ⑤ ⑥ ⑦ ⑧	■	10

By slotting the lamellas on the periphery, the flexibility of this type of mounted wheel is increased.

The slotted flap wheel quickly profiles itself to the contour of the workpiece.

The stated maximum operating speed only applies to a maximum overhang L_0 of 20 mm.

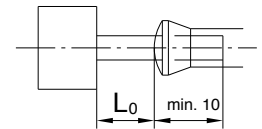

Grinding, Polishing (flexible)

SFE, Flap wheels of abrasive cloth, regular aluminium oxide, special bond

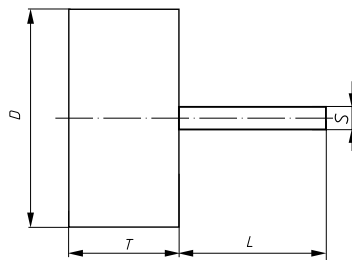

Ordering example: A2201030103120

Further dimensions, qualities and shank lengths on request

NKE = reg. Aluminium Oxide with a coating of active grinding additives

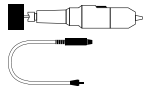

PG 14

Product number	Description	Grit	D mm	T mm	S mm	L mm	n recom. (1/min)	n max. (1/min)	recommended for Information on page 438		
A2201030103120	SFE 03010.03	NKE 120	30	10	3	40	16.000	18.000	① ② ③ ④ ⑤ ⑥ ⑦ ⑧	■	10
A2201030106060	SFE 03010.06	NKE 60	30	10	6	40	16.000	25.400	① ② ③ ④ ⑤ ⑥ ⑦ ⑧	■	10
A2201030106080	SFE 03010.06	NKE 80	30	10	6	40	16.000	25.400	① ② ③ ④ ⑤ ⑥ ⑦ ⑧	■	10
A2201030106150	SFE 03010.06	NKE 150	30	10	6	40	16.000	25.400	① ② ③ ④ ⑤ ⑥ ⑦ ⑧	■	10
A2201040156060	SFE 04015.06	NKE 60	40	15	6	40	12.000	19.100	① ② ③ ④ ⑤ ⑥ ⑦ ⑧	■	10
A2201040156080	SFE 04015.06	NKE 80	40	15	6	40	12.000	19.100	① ② ③ ④ ⑤ ⑥ ⑦ ⑧	■	10
A2201040156120	SFE 04015.06	NKE 120	40	15	6	40	12.000	19.100	① ② ③ ④ ⑤ ⑥ ⑦ ⑧	■	10
A2201050156080	SFE 05015.06	NKE 80	50	15	6	40	9.000	15.300	① ② ③ ④ ⑤ ⑥ ⑦ ⑧	■	10
A2201050156150	SFE 05015.06	NKE 150	50	15	6	40	9.000	15.300	① ② ③ ④ ⑤ ⑥ ⑦ ⑧	■	10
A2201060206080	SFE 06020.06	NKE 80	60	20	6	40	8.000	12.700	① ② ③ ④ ⑤ ⑥ ⑦ ⑧	■	10
A2201060306060	SFE 06030.06	NKE 60	60	30	6	40	8.000	12.700	① ② ③ ④ ⑤ ⑥ ⑦ ⑧	■	10
A2201060306080	SFE 06030.06	NKE 80	60	30	6	40	8.000	12.700	① ② ③ ④ ⑤ ⑥ ⑦ ⑧	■	10
A2201060306120	SFE 06030.06	NKE 120	60	30	6	40	8.000	12.700	① ② ③ ④ ⑤ ⑥ ⑦ ⑧	■	10
A2201060306150	SFE 06030.06	NKE 150	60	30	6	40	8.000	12.700	① ② ③ ④ ⑤ ⑥ ⑦ ⑧	■	10
A2201060506060	SFE 06050.06	NKE 60	60	50	6	40	8.000	8.500	① ② ③ ④ ⑤ ⑥ ⑦ ⑧	■	10
A2201060506120	SFE 06050.06	NKE 120	60	50	6	40	8.000	8.500	① ② ③ ④ ⑤ ⑥ ⑦ ⑧	■	10
A2201080306080	SFE 08030.06	NKE 80	80	30	6	40	6.000	9.500	① ② ③ ④ ⑤ ⑥ ⑦ ⑧	■	10
A2201080506080	SFE 08050.06	NKE 80	80	50	6	40	6.000	7.500	① ② ③ ④ ⑤ ⑥ ⑦ ⑧	■	10

The stated maximum operating speed only applies to a maximum overhang L₀ of 20 mm.

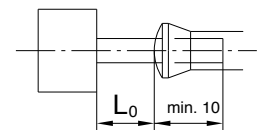

Grinding, Polishing (flexible)

SFC, Flap wheels of abrasive cloth, silicon carbide

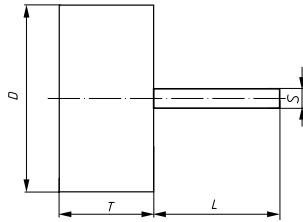

Ordering example: A2202030106080

Further dimensions, qualities and shank lengths on request

SIC = silicon carbide

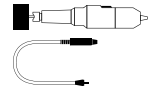

PG 14

Product number	Description	Grit	D mm	T mm	S mm	L mm	n recom. (1/min)	n max. (1/min)	recommended for									Information on page 438	10
									①	②	③	④	⑤	⑥	⑦	⑧	⑨		
A2202030106080	SFC 03010.06	SIC 80	30	10	6	40	16.000	25.400	①	②	③	④	⑤	⑥	⑦	⑧	⑨	■	10
A2202030106150	SFC 03010.06	SIC 150	30	10	6	40	16.000	25.400	①	②	③	④	⑤	⑥	⑦	⑧	⑨	■	10
A2202040156080	SFC 04015.06	SIC 80	40	15	6	40	12.000	19.100	①	②	③	④	⑤	⑥	⑦	⑧	⑨	■	10
A2202060206080	SFC 06020.06	SIC 80	60	20	6	40	8.000	12.700	①	②	③	④	⑤	⑥	⑦	⑧	⑨	■	10
A2202060206120	SFC 06020.06	SIC 120	60	20	6	40	8.000	12.700	①	②	③	④	⑤	⑥	⑦	⑧	⑨	■	10
A2202060306120	SFC 06030.06	SIC 120	60	30	6	40	8.000	12.700	①	②	③	④	⑤	⑥	⑦	⑧	⑨	■	10

The stated maximum operating speed only applies to a maximum overhang L₀ of 20 mm.

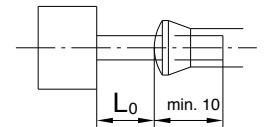

Grinding, Polishing (flexible)

SFI, Mounted flap wheels of abrasive cloth, with internal thread

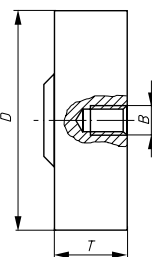

Ordering example: A2207030050120

Further dimensions and qualities on request.

NK = reg. Aluminium Oxide

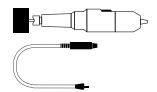

PG 14

Product number	Description	Grit	D mm	T mm	Thread B	n recom. (1/min)	n max. (1/min)	suitable tool adaptor	recommended for								Information on page 438	10
									①	②	③	④	⑤	⑥	⑦	⑧		
A2207030050120	SFI 03005.M4	NK 120	30	5	M4	16.000	18.000	WADI 0404	①	②	③	④	⑤	⑥	⑦	⑧	■	10
A2207030100120	SFI 03010.M4	NK 120	30	10	M4	16.000	18.000	WADI 0407	①	②	③	④	⑤	⑥	⑦	⑧	■	10
A2207030100150	SFI 03010.M4	NK 150	30	10	M4	16.000	18.000	WADI 0407	①	②	③	④	⑤	⑥	⑦	⑧	■	10
A2207040150080	SFI 04015.M6	NK 80	40	15	M6	10.000	10.000	WADI 0609	①	②	③	④	⑤	⑥	⑦	⑧	■	10
A2207040150120	SFI 04015.M6	NK 120	40	15	M6	10.000	10.000	WADI 0609	①	②	③	④	⑤	⑥	⑦	⑧	■	10
A2207050200080	SFI 05020.M6	NK 80	50	20	M6	7.500	7.500	WADI 0612	①	②	③	④	⑤	⑥	⑦	⑧	■	10

The stated maximum permissible operating speed is only valid if the correct tool adaptor is used (see page 249).

Adaptor for SFI

★★☆

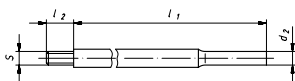

Ordering example: A36300404

Used only for mounted flap wheels page 248.

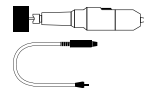

PG 8

Product number	Description	d ₂ mm	l ₁ mm	S mm	l ₂ mm	recommended for Information on page 438		
A36300404	WADI 0404	6	80	M4	4		■	1
A36300407	WADI 0407	6	80	M4	7		■	1
A36300609	WADI 0609	6	100	M6	9		■	1
A36300612	WADI 0612	6	100	M6	12		■	1

Grinding, Polishing (flexible)

SFA, Flap wheels of abrasive cloth, with external thread



★★☆

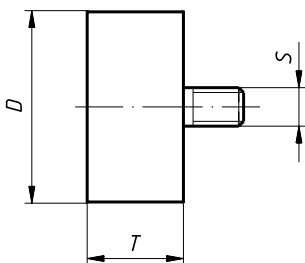

Ordering example: A2200015055150

Further dimensions and qualities on request.

NK = reg. Aluminium Oxide

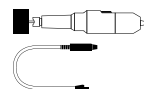

PG 14

Product number	Description	Grit	D mm	T mm	Thread S	n recom. (1/min)	n max. (1/min)	recommended for Information on page 438		
A2200015055150	SFA 01505.M5	NK 150	15	5	M5	16.000	18.000	① ② ③ ④ ⑤ ⑥ ⑦ ⑧	■	10
A2200015055240	SFA 01505.M5	NK 240	15	5	M5	16.000	18.000	① ② ③ ④ ⑤ ⑥ ⑦ ⑧	■	10
A2200020055150	SFA 02005.M5	NK 150	20	5	M5	16.000	18.000	① ② ③ ④ ⑤ ⑥ ⑦ ⑧	■	10
A2200020055240	SFA 02005.M5	NK 240	20	5	M5	16.000	18.000	① ② ③ ④ ⑤ ⑥ ⑦ ⑧	■	10
A2200030055120	SFA 03005.M5	NK 120	30	5	M5	16.000	18.000	① ② ③ ④ ⑤ ⑥ ⑦ ⑧	■	10
A2200030055150	SFA 03005.M5	NK 150	30	5	M5	16.000	18.000	① ② ③ ④ ⑤ ⑥ ⑦ ⑧	■	10
A2200030055240	SFA 03005.M5	NK 240	30	5	M5	16.000	18.000	① ② ③ ④ ⑤ ⑥ ⑦ ⑧	■	10

The stated maximum permissible operating speed is only valid if the correct tool adaptor is used (see page 250).

Adaptor for SFA

★★☆

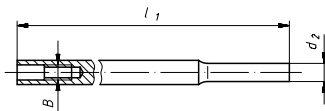

Ordering example: A36300518

Used only for mounted flap wheels page 249.

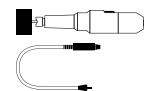

PG 8

Product number	Description	d ₂ mm	l ₁ mm	B mm	recommended for	Information on page 438			
A36300518	WADA 05	6	100	M5				■	1

MFS, Mini-Flap wheels of abrasive cloth



★★☆



Ordering example: A2205015106150



PG 14

Product number	Description	Grit	D mm	T mm	S mm	L mm	n max. (1/min)	recommended for	Information on page 438			
A2205015106150	MFS 01510.06	NK 150	15	10	6	40	18.000	① ② ③ ④ ⑤ ⑥ ⑦ ⑧		■	10	
A2205015106150001	MFS 01510.06	NK 150	15	10	6	100	18.000	① ② ③ ④ ⑤ ⑥ ⑦ ⑧		■	10	
A2205015306150	MFS 01530.06	NK 150	15	30	6	40	18.000	① ② ③ ④ ⑤ ⑥ ⑦ ⑧		■	10	
A2205015306150001	MFS 01530.06	NK 150	15	30	6	100	18.000	① ② ③ ④ ⑤ ⑥ ⑦ ⑧		■	10	
A2205020106150	MFS 02010.06	NK 150	20	10	6	40	18.000	① ② ③ ④ ⑤ ⑥ ⑦ ⑧		■	10	
A2205020106150001	MFS 02010.06	NK 150	20	10	6	100	18.000	① ② ③ ④ ⑤ ⑥ ⑦ ⑧		■	10	
A2205020306150	MFS 02030.06	NK 150	20	30	6	40	18.000	① ② ③ ④ ⑤ ⑥ ⑦ ⑧		■	10	
A2205020306150001	MFS 02030.06	NK 150	20	30	6	100	18.000	① ② ③ ④ ⑤ ⑥ ⑦ ⑧		■	10	
A2205025106150	MFS 02510.06	NK 150	25	10	6	40	18.000	① ② ③ ④ ⑤ ⑥ ⑦ ⑧		■	10	
A2205025106150001	MFS 02510.06	NK 150	25	10	6	100	18.000	① ② ③ ④ ⑤ ⑥ ⑦ ⑧		■	10	
A2205025306150	MFS 02530.06	NK 150	25	30	6	40	18.000	① ② ③ ④ ⑤ ⑥ ⑦ ⑧		■	10	
A2205025306150001	MFS 02530.06	NK 150	25	30	6	100	18.000	① ② ③ ④ ⑤ ⑥ ⑦ ⑧		■	10	

Range of application:

- deburring of drill holes
- production and cleaning of moulds for glass-industry
- inside processing/machining of tubes
- processing of the borings of turbine blades
- manifold special applications

Advantages:

- Possibility of fine-grinding and finishing work
- The arrangement of the lamellars ensure high flexibility
- Good circulation of air and tough cold grinding
- Processing of small borings and inner-diameters of tubes

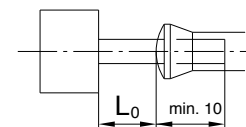

For the safe use of mini-flap wheels with long shank, it is necessary to hold the mini-flap wheel against the workpiece before starting the machine or to insert it into holes or channels. Contact with the workpiece must be ensured until the machine is switched off.

Flap wheel consisting of an abrasive fleece and abrasive cloth combination

196 Qualities and Applications

252 General Information

253 Mounted flap wheels abrasive fleece lamellar inserts

256 Mounted flap wheels abrasive fleece disc inserts

256 Mounted flap wheels of abrasive fleece / abrasive cloth combination

Product line marking

The product lines are illustrated by star symbols at the top of the table; please refer to page **14** and **15**.

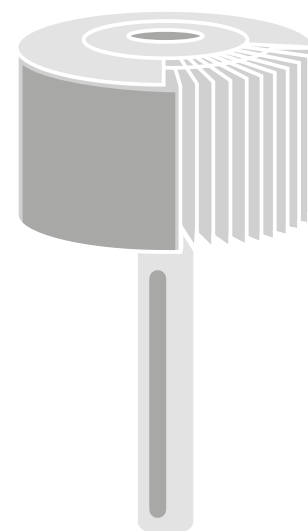

Grinding, Polishing
(flexible)



Information

SFV, Flap wheels of fleece flaps

These tools consist of individual flaps radially located around the hub of the tool. They are available in regular aluminium oxide (A), silicon carbide (C) and zirconia aluminium oxide (Z). SFV are mainly used in hand-held power tools.

Examples of application:

- matting
- conditioning
- polishing
- finishing
- fine surface finishing

SFR, Mounted fleece discs

These special tools are produced by layering individual flexible round fleece sections. They are therefore ideally suited to the machining of profiles.

SFM, Flap wheels of abrasive fleece with abrasive cloth

These tools consist of individual flaps radially located around the hub of the tool. They are available in regular aluminium oxide (A), silicon carbide (C) and zirconia aluminium oxide.

The combination of coated abrasive and abrasive fleece allows for a greater stock removal compared to the SFV product type. SFM are mainly used in hand-held power tools.

Examples of application:

- preparation work
- de-rusting
- pre-finishing
- graining
- keying

SFM, spindle mounted flap wheels with TF-material

These tools are particularly suited to stainless steel applications. The reverse side of the reinforced abrasive fleece guarantees uniform wear of the fleece and the coated abrasive flaps. Please take note of the rotational direction!

Quality	Grit sizes
A104	Aluminium oxide 100
A106	Aluminium oxide 180
A107	Aluminium oxide 280
C204	Silicon carbide 100
C206	Silicon carbide 180
C207	Silicon carbide 280
C208	Silicon carbide 400
Z304	Zirconia Alum. Oxide 100
Z306	Zirconia Alum. Oxide 180
Z307	Zirconia Alum. Oxide 280

SFV, Flap wheels of fleece flaps, reg. Aluminium Oxide

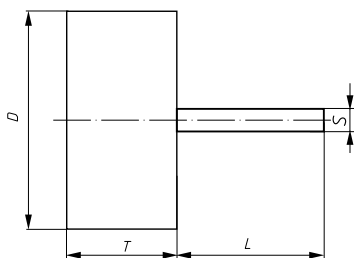

Ordering example: A2203030106306

Further dimensions, qualities and shank lengths on request

Z = Zirconia aluminium oxide

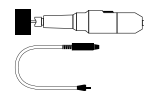

PG 14

Product number	Description	Grit	D mm	T mm	S mm	L mm	n recom. (1/min)	n max (1/min)	recommended for Information on page 438		
A2203030106306	SFV 03010.06	Z 306	30	10	6	40	10.000	14.000	① ② ③ ④ ⑤ ⑥ ⑦ ⑧	■	10
A2203040206306	SFV 04020.06	Z 306	40	20	6	40	7500	14.000	① ② ③ ④ ⑤ ⑥ ⑦ ⑧	■	10
A2203050106306	SFV 05010.06	Z 306	50	10	6	40	6.000	11.000	① ② ③ ④ ⑤ ⑥ ⑦ ⑧	■	10
A2203060306306	SFV 06030.06	Z 306	60	30	6	40	5.000	9.000	① ② ③ ④ ⑤ ⑥ ⑦ ⑧	■	10
A2203080506306	SFV 08050.06	Z 306	80	50	6	40	4.000	7.000	① ② ③ ④ ⑤ ⑥ ⑦ ⑧	■	10

The stated maximum operating speed only applies to a maximum overhang L₀ of 20 mm.

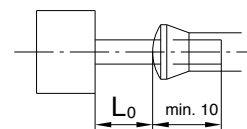

Grinding, Polishing (flexible)

SFV, Flap wheels of fleece flaps, reg. Aluminium Oxide

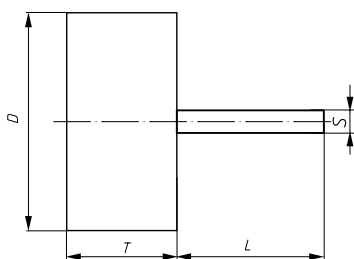

Ordering example: A2203030206106

Further dimensions, qualities and shank lengths on request

A = reg. Aluminium Oxide

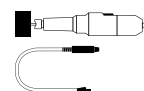

PG 14

Product number	Description	Grit	D mm	T mm	S mm	L mm	n recom. (1/min)	n max. (1/min)	recommended for Information on page 438		
A2203030206106	SFV 03020.06	A 106	30	20	6	40	10.000	14.000	① ② ③ ④ ⑤ ⑥ ⑦ ⑧	■	10
A2203030406107	SFV 03040.06	A 107	30	40	6	40	10.000	14.000	① ② ③ ④ ⑤ ⑥ ⑦ ⑧	■	10
A2203040206104	SFV 04020.06	A 104	40	20	6	40	7500	14.000	① ② ③ ④ ⑤ ⑥ ⑦ ⑧	■	10
A2203040206106	SFV 04020.06	A 106	40	20	6	40	7500	14.000	① ② ③ ④ ⑤ ⑥ ⑦ ⑧	■	10
A2203040206107	SFV 04020.06	A 107	40	20	6	40	7500	14.000	① ② ③ ④ ⑤ ⑥ ⑦ ⑧	■	10
A2203040306104	SFV 04030.06	A 104	40	30	6	40	7500	14.000	① ② ③ ④ ⑤ ⑥ ⑦ ⑧	■	10
A2203040306106	SFV 04030.06	A 106	40	30	6	40	7500	14.000	① ② ③ ④ ⑤ ⑥ ⑦ ⑧	■	10
A2203040306107	SFV 04030.06	A 107	40	30	6	40	7500	14.000	① ② ③ ④ ⑤ ⑥ ⑦ ⑧	■	10

The stated maximum operating speed only applies to a maximum overhang L₀ of 20 mm.

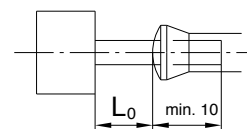

SFV, Flap wheels of fleece flaps, reg. Aluminium Oxide

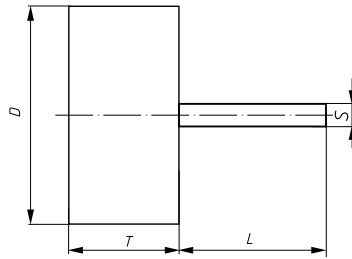

Ordering example: A2203050106106

Further dimensions, qualities and shank lengths on request

A = reg. Aluminium Oxide

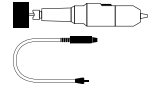

PG 14

Product number	Description	Grit	D mm	T mm	S mm	L mm	n recom. (1/min)	n max. (1/min)	recommended for Information on page 438		
A2203050106106	SFV 05010.06	A 106	50	10	6	40	6.000	11.000	① ② ③ ④ ⑤ ⑥ ⑦ ⑧	■	10
A2203050206104	SFV 05020.06	A 104	50	20	6	40	6.000	11.000	① ② ③ ④ ⑤ ⑥ ⑦ ⑧	■	10
A2203050206106	SFV 05020.06	A 106	50	20	6	40	6.000	11.000	① ② ③ ④ ⑤ ⑥ ⑦ ⑧	■	10
A2203050306104	SFV 05030.06	A 104	50	30	6	40	6.000	11.000	① ② ③ ④ ⑤ ⑥ ⑦ ⑧	■	10
A2203050306106	SFV 05030.06	A 106	50	30	6	40	6.000	11.000	① ② ③ ④ ⑤ ⑥ ⑦ ⑧	■	10
A2203050306107	SFV 05030.06	A 107	50	30	6	40	6.000	11.000	① ② ③ ④ ⑤ ⑥ ⑦ ⑧	■	10
A2203050406104	SFV 05040.06	A 104	50	40	6	40	6.000	11.000	① ② ③ ④ ⑤ ⑥ ⑦ ⑧	■	10
A2203050406106	SFV 05040.06	A 106	50	40	6	40	6.000	11.000	① ② ③ ④ ⑤ ⑥ ⑦ ⑧	■	10
A2203050406107	SFV 05040.06	A 107	50	40	6	40	6.000	11.000	① ② ③ ④ ⑤ ⑥ ⑦ ⑧	■	10
A2203060306104	SFV 06030.06	A 104	60	30	6	40	5.000	9.000	① ② ③ ④ ⑤ ⑥ ⑦ ⑧	■	10
A2203060306106	SFV 06030.06	A 106	60	30	6	40	5.000	9.000	① ② ③ ④ ⑤ ⑥ ⑦ ⑧	■	10
A2203060306107	SFV 06030.06	A 107	60	30	6	40	5.000	9.000	① ② ③ ④ ⑤ ⑥ ⑦ ⑧	■	10
A2203060406104	SFV 06040.06	A 104	60	40	6	40	5.000	9.000	① ② ③ ④ ⑤ ⑥ ⑦ ⑧	■	10
A2203060406106	SFV 06040.06	A 106	60	40	6	40	5.000	9.000	① ② ③ ④ ⑤ ⑥ ⑦ ⑧	■	10
A2203060406107	SFV 06040.06	A 107	60	40	6	40	5.000	9.000	① ② ③ ④ ⑤ ⑥ ⑦ ⑧	■	10
A2203060506104	SFV 06050.06	A 104	60	50	6	40	5.000	9.000	① ② ③ ④ ⑤ ⑥ ⑦ ⑧	■	10
A2203060506106	SFV 06050.06	A 106	60	50	6	40	5.000	9.000	① ② ③ ④ ⑤ ⑥ ⑦ ⑧	■	10
A2203060506107	SFV 06050.06	A 107	60	50	6	40	5.000	9.000	① ② ③ ④ ⑤ ⑥ ⑦ ⑧	■	10
A2203080406104	SFV 08040.06	A 104	80	40	6	40	4.000	7.000	① ② ③ ④ ⑤ ⑥ ⑦ ⑧	■	10
A2203080406106	SFV 08040.06	A 106	80	40	6	40	4.000	7.000	① ② ③ ④ ⑤ ⑥ ⑦ ⑧	■	10
A2203080506104	SFV 08050.06	A 104	80	50	6	40	4.000	7.000	① ② ③ ④ ⑤ ⑥ ⑦ ⑧	■	10
A2203080506106	SFV 08050.06	A 106	80	50	6	40	4.000	7.000	① ② ③ ④ ⑤ ⑥ ⑦ ⑧	■	10
A2203080506107	SFV 08050.06	A 107	80	50	6	40	4.000	7.000	① ② ③ ④ ⑤ ⑥ ⑦ ⑧	■	10

The stated maximum operating speed only applies to a maximum overhang L_0 of 20 mm.

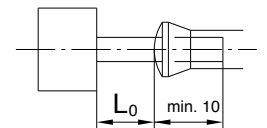

Grinding, Polishing (flexible)

SFV, Flap wheels of fleece flaps, Silicon carbide

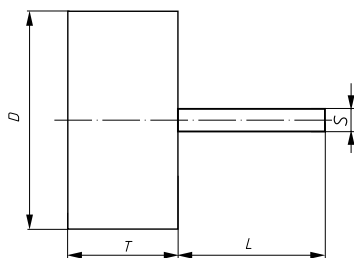

Ordering example: A2203020153207

Further dimensions, qualities and shank lengths on request

C = Silicon carbide

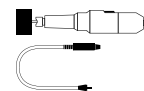

PG 14

Product number	Description	Grit	D mm	T mm	S mm	L mm	n recom. (1/min)	n max. (1/min)	recommended for									Information on page 438	10
									①	②	③	④	⑤	⑥	⑦	⑧	⑨		
A2203020153207	SFV 02015.03	C 207	20	15	3	40	10.000	14.000	①	②	③	④	⑤	⑥	⑦	⑧	⑨	■	10
A2203040206206	SFV 04020.06	C 206	40	20	6	40	7.500	14.000	①	②	③	④	⑤	⑥	⑦	⑧	⑨	■	10
A2203040206207	SFV 04020.06	C 207	40	20	6	40	7.500	14.000	①	②	③	④	⑤	⑥	⑦	⑧	⑨	■	10
A2203040306207	SFV 04030.06	C 207	40	30	6	40	7.500	14.000	①	②	③	④	⑤	⑥	⑦	⑧	⑨	■	10
A2203050206204	SFV 05020.06	C 204	50	20	6	40	6.000	11.000	①	②	③	④	⑤	⑥	⑦	⑧	⑨	■	10
A2203050206206	SFV 05020.06	C 206	50	20	6	40	6.000	11.000	①	②	③	④	⑤	⑥	⑦	⑧	⑨	■	10
A2203050206207	SFV 05020.06	C 207	50	20	6	40	6.000	11.000	①	②	③	④	⑤	⑥	⑦	⑧	⑨	■	10
A2203050306207	SFV 05030.06	C 207	50	30	6	40	6.000	11.000	①	②	③	④	⑤	⑥	⑦	⑧	⑨	■	10
A2203050406207	SFV 05040.06	C 207	50	40	6	40	6.000	11.000	①	②	③	④	⑤	⑥	⑦	⑧	⑨	■	10
A2203060306204	SFV 06030.06	C 204	60	30	6	40	5.000	9.000	①	②	③	④	⑤	⑥	⑦	⑧	⑨	■	10
A2203060306206	SFV 06030.06	C 206	60	30	6	40	5.000	9.000	①	②	③	④	⑤	⑥	⑦	⑧	⑨	■	10
A2203060306207	SFV 06030.06	C 207	60	30	6	40	5.000	9.000	①	②	③	④	⑤	⑥	⑦	⑧	⑨	■	10
A2203060406204	SFV 06040.06	C 204	60	40	6	40	5.000	9.000	①	②	③	④	⑤	⑥	⑦	⑧	⑨	■	10
A2203060406207	SFV 06040.06	C 207	60	40	6	40	5.000	9.000	①	②	③	④	⑤	⑥	⑦	⑧	⑨	■	10
A2203060506207	SFV 06050.06	C 207	60	50	6	40	5.000	9.000	①	②	③	④	⑤	⑥	⑦	⑧	⑨	■	10
A2203080406204	SFV 08040.06	C 204	80	40	6	40	4.000	7.000	①	②	③	④	⑤	⑥	⑦	⑧	⑨	■	10
A2203080406206	SFV 08040.06	C 206	80	40	6	40	4.000	7.000	①	②	③	④	⑤	⑥	⑦	⑧	⑨	■	10
A2203080406207	SFV 08040.06	C 207	80	40	6	40	4.000	7.000	①	②	③	④	⑤	⑥	⑦	⑧	⑨	■	10
A2203080506204	SFV 08050.06	C 204	80	50	6	40	4.000	7.000	①	②	③	④	⑤	⑥	⑦	⑧	⑨	■	10
A2203080506206	SFV 08050.06	C 206	80	50	6	40	4.000	7.000	①	②	③	④	⑤	⑥	⑦	⑧	⑨	■	10
A2203080506207	SFV 08050.06	C 207	80	50	6	40	4.000	7.000	①	②	③	④	⑤	⑥	⑦	⑧	⑨	■	10

The stated maximum operating speed only applies to a maximum overhang L₀ of 20 mm.

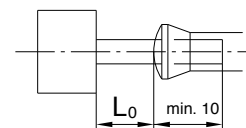

Grinding, Polishing (flexible)

SFR, Mounted fleece discs

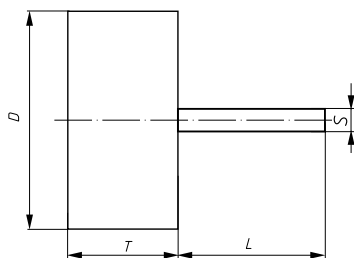

Ordering example: A2223060506104

Further dimensions, qualities and shank lengths on request

A = reg. Aluminium Oxide

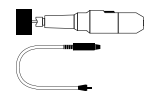

PG 14

Product number	Description	Grit	D mm	T mm	S mm	L mm	n recom. (1/min)	n max. (1/min)	recommended for Information on page 438		
A2223060506104	SFR 06050.06	A 104	60	50	6	40	5.000	9.000	① ② ③ ④ ⑤ ⑥ ⑦ ⑧	■	10
A2223060506106	SFR 06050.06	A 106	60	50	6	40	5.000	9.000	① ② ③ ④ ⑤ ⑥ ⑦ ⑧	■	10
A2223060506107	SFR 06050.06	A 107	60	50	6	40	5.000	9.000	① ② ③ ④ ⑤ ⑥ ⑦ ⑧	■	10
A2223080506104	SFR 08050.06	A 104	80	50	6	40	4.000	7.000	① ② ③ ④ ⑤ ⑥ ⑦ ⑧	■	10
A2223080506106	SFR 08050.06	A 106	80	50	6	40	4.000	7.000	① ② ③ ④ ⑤ ⑥ ⑦ ⑧	■	10
A2223080506107	SFR 08050.06	A 107	80	50	6	40	4.000	7.000	① ② ③ ④ ⑤ ⑥ ⑦ ⑧	■	10

The stated maximum operating speed only applies to a maximum overhang L_0 of 20 mm.

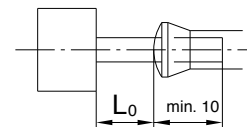

Grinding, Polishing (flexible)

SFM, Flap wheels of abrasive fleece TF with abrasive cloth

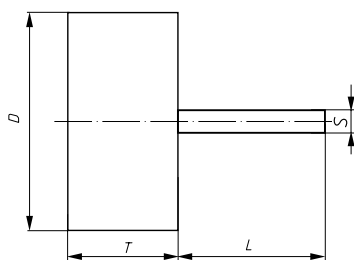

Ordering example: A2204040206120

TF = Special quality for INOX

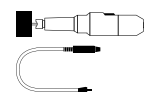

PG 14

Product number	Description	Grit	D mm	T mm	S mm	L mm	n recom. (1/min)	n max. (1/min)	recommended for Information on page 438		
A2204040206120	SFM 04020.06	TF 120/80	40	20	6	40	7.500	14.000	① ② ③ ④ ⑤ ⑥ ⑦ ⑧	■	10
A2204060306120	SFM 06030.06	TF 120/80	60	30	6	40	5.000	9.000	① ② ③ ④ ⑤ ⑥ ⑦ ⑧	■	10
A2204080506120	SFM 08050.06	TF 120/80	80	50	6	40	4.000	7.000	① ② ③ ④ ⑤ ⑥ ⑦ ⑧	■	10
A2204080406120	SFM 08040.06	TF 120/150	80	40	6	40	4.000	7.000	① ② ③ ④ ⑤ ⑥ ⑦ ⑧	■	10

Ideal for surface finishing of metalsheet components such as stainless steel sinks and containers.

The stated maximum operating speed only applies to a maximum overhang L_0 of 20 mm.

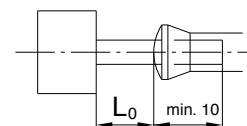

SFM, Flap wheels of abrasive fleece with abrasive cloth, reg. Aluminium Oxide

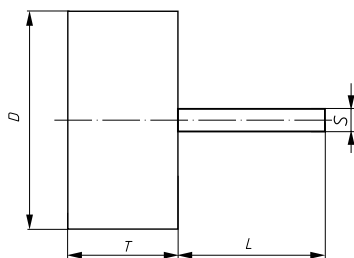

Ordering example: A2204030306104

Further dimensions, qualities and shank lengths on request

A = reg. Aluminium Oxide

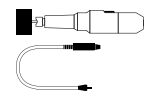

PG 14

Product number	Description	Grit	D mm	T mm	S mm	L mm	n recom. (1/min)	n max. (1/min)	recommended for Information on page 438		
A2204030306104	SFM 03030.06	A 104/80	30	30	6	40	10.000	14.000	① ② ③ ④ ⑤ ⑥ ⑦ ⑧	■	10
A2204040206104	SFM 04020.06	A 104/80	40	20	6	40	7.500	14.000	① ② ③ ④ ⑤ ⑥ ⑦ ⑧	■	10
A2204040206106	SFM 04020.06	A 106/150	40	20	6	40	7.500	14.000	① ② ③ ④ ⑤ ⑥ ⑦ ⑧	■	10
A2204040206107	SFM 04020.06	A 107/240	40	20	6	40	7.500	14.000	① ② ③ ④ ⑤ ⑥ ⑦ ⑧	■	10
A2204040306104	SFM 04030.06	A 104/80	40	30	6	40	7.500	14.000	① ② ③ ④ ⑤ ⑥ ⑦ ⑧	■	10
A2204040306106	SFM 04030.06	A 106/150	40	30	6	40	7.500	14.000	① ② ③ ④ ⑤ ⑥ ⑦ ⑧	■	10
A2204040306107	SFM 04030.06	A 107/240	40	30	6	40	7.500	14.000	① ② ③ ④ ⑤ ⑥ ⑦ ⑧	■	10
A2204050206104	SFM 05020.06	A 104/80	50	20	6	40	6.000	11.000	① ② ③ ④ ⑤ ⑥ ⑦ ⑧	■	10
A2204050206106	SFM 05020.06	A 106/150	50	20	6	40	6.000	11.000	① ② ③ ④ ⑤ ⑥ ⑦ ⑧	■	10
A2204050306106	SFM 05030.06	A 106/150	50	30	6	40	6.000	11.000	① ② ③ ④ ⑤ ⑥ ⑦ ⑧	■	10
A2204050306107	SFM 05030.06	A 107/240	50	30	6	40	6.000	11.000	① ② ③ ④ ⑤ ⑥ ⑦ ⑧	■	10
A2204050406104	SFM 05040.06	A 104/80	50	40	6	40	6.000	11.000	① ② ③ ④ ⑤ ⑥ ⑦ ⑧	■	10
A2204050406106	SFM 05040.06	A 106/150	50	40	6	40	6.000	11.000	① ② ③ ④ ⑤ ⑥ ⑦ ⑧	■	10
A2204060306104	SFM 06030.06	A 104/80	60	30	6	40	5.000	9.000	① ② ③ ④ ⑤ ⑥ ⑦ ⑧	■	10
A2204060306106	SFM 06030.06	A 106/150	60	30	6	40	5.000	9.000	① ② ③ ④ ⑤ ⑥ ⑦ ⑧	■	10
A2204060306107	SFM 06030.06	A 107/240	60	30	6	40	5.000	9.000	① ② ③ ④ ⑤ ⑥ ⑦ ⑧	■	10
A2204060406104	SFM 06040.06	A 104/80	60	40	6	40	5.000	9.000	① ② ③ ④ ⑤ ⑥ ⑦ ⑧	■	10
A2204060406106	SFM 06040.06	A 106/150	60	40	6	40	5.000	9.000	① ② ③ ④ ⑤ ⑥ ⑦ ⑧	■	10
A2204060406107	SFM 06040.06	A 107/240	60	40	6	40	5.000	9.000	① ② ③ ④ ⑤ ⑥ ⑦ ⑧	■	10
A2204060506104	SFM 06050.06	A 104/80	60	50	6	40	5.000	9.000	① ② ③ ④ ⑤ ⑥ ⑦ ⑧	■	10
A2204060506106	SFM 06050.06	A 106/150	60	50	6	40	5.000	9.000	① ② ③ ④ ⑤ ⑥ ⑦ ⑧	■	10
A2204080406104	SFM 08040.06	A 104/80	80	40	6	40	4.000	7.000	① ② ③ ④ ⑤ ⑥ ⑦ ⑧	■	10
A2204080406106	SFM 08040.06	A 106/150	80	40	6	40	4.000	7.000	① ② ③ ④ ⑤ ⑥ ⑦ ⑧	■	10
A2204080406107	SFM 08040.06	A 107/240	80	40	6	40	4.000	7.000	① ② ③ ④ ⑤ ⑥ ⑦ ⑧	■	10
A2204080506104	SFM 08050.06	A 104/80	80	50	6	40	4.000	7.000	① ② ③ ④ ⑤ ⑥ ⑦ ⑧	■	10
A2204080506106	SFM 08050.06	A 106/150	80	50	6	40	4.000	7.000	① ② ③ ④ ⑤ ⑥ ⑦ ⑧	■	10
A2204080506107	SFM 08050.06	A 107/240	80	50	6	40	4.000	7.000	① ② ③ ④ ⑤ ⑥ ⑦ ⑧	■	10

The stated maximum operating speed only applies to a maximum overhang L_0 of 20 mm.

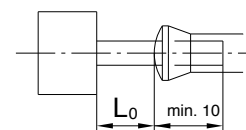

Grinding, Polishing (flexible)

SFM, Flap wheels of abrasive fleece with abrasive cloth, Silicon carbide

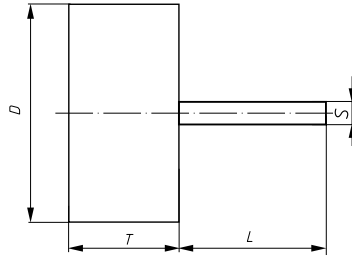

Ordering example A2204040206204

Further dimensions, qualities and shank lengths on request

C = Silicon carbide

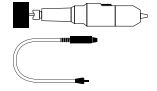

PG 14

Product number	Description	Grit	D mm	T mm	S mm	L mm	n recom. (1/min)	n max. (1/min)	recommended for Information on page 438		
A2204040206204	SFM 04020.06	C 204/80	40	20	6	40	7500	14.000	① ② ③ ④ ⑤ ⑥ ⑦ ⑧ ⑨	■	10
A2204040206206	SFM 04020.06	C 206/150	40	20	6	40	7500	14.000	① ② ③ ④ ⑤ ⑥ ⑦ ⑧ ⑨	■	10
A2204040306204	SFM 04030.06	C 204/80	40	30	6	40	7500	14.000	① ② ③ ④ ⑤ ⑥ ⑦ ⑧ ⑨	■	10
A2204040306206	SFM 04030.06	C 206/150	40	30	6	40	7500	14.000	① ② ③ ④ ⑤ ⑥ ⑦ ⑧ ⑨	■	10
A2204040306207	SFM 04030.06	C 207/240	40	30	6	40	7500	14.000	① ② ③ ④ ⑤ ⑥ ⑦ ⑧ ⑨	■	10
A2204050206204	SFM 05020.06	C 204/80	50	20	6	40	6.000	11.000	① ② ③ ④ ⑤ ⑥ ⑦ ⑧ ⑨	■	10
A2204050206206	SFM 05020.06	C 206/150	50	20	6	40	6.000	11.000	① ② ③ ④ ⑤ ⑥ ⑦ ⑧ ⑨	■	10
A2204060306204	SFM 06030.06	C 204/80	60	30	6	40	5.000	9.000	① ② ③ ④ ⑤ ⑥ ⑦ ⑧ ⑨	■	10
A2204060306206	SFM 06030.06	C 206/150	60	30	6	40	5.000	9.000	① ② ③ ④ ⑤ ⑥ ⑦ ⑧ ⑨	■	10
A2204060306207	SFM 06030.06	C 207/240	60	30	6	40	5.000	9.000	① ② ③ ④ ⑤ ⑥ ⑦ ⑧ ⑨	■	10
A2204060406204	SFM 06040.06	C 204/80	60	40	6	40	5.000	9.000	① ② ③ ④ ⑤ ⑥ ⑦ ⑧ ⑨	■	10
A2204080506204	SFM 08050.06	C 204/80	80	50	6	40	4.000	7.000	① ② ③ ④ ⑤ ⑥ ⑦ ⑧ ⑨	■	10
A2204080506206	SFM 08050.06	C 206/150	80	50	6	40	4.000	7.000	① ② ③ ④ ⑤ ⑥ ⑦ ⑧ ⑨	■	10

The stated maximum operating speed only applies to a maximum overhang L_0 of 20 mm.

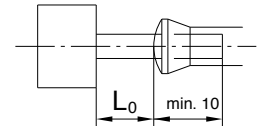

Grinding, Polishing (flexible)

Flap wheels

196 Qualities and Applications

260 General Information

261 Flap wheels of abrasive cloth for angle grinder

262 Flap wheels of abrasive cloth

266 Flap wheels of abrasive fleece/
abrasive cloth combination

267 Fleece mops

Product line marking

The product lines are illustrated by star symbols at the top of the table; please refer to page **14** and **15**.

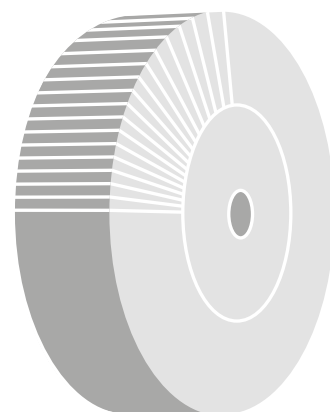

Grinding, Polishing
(flexible)

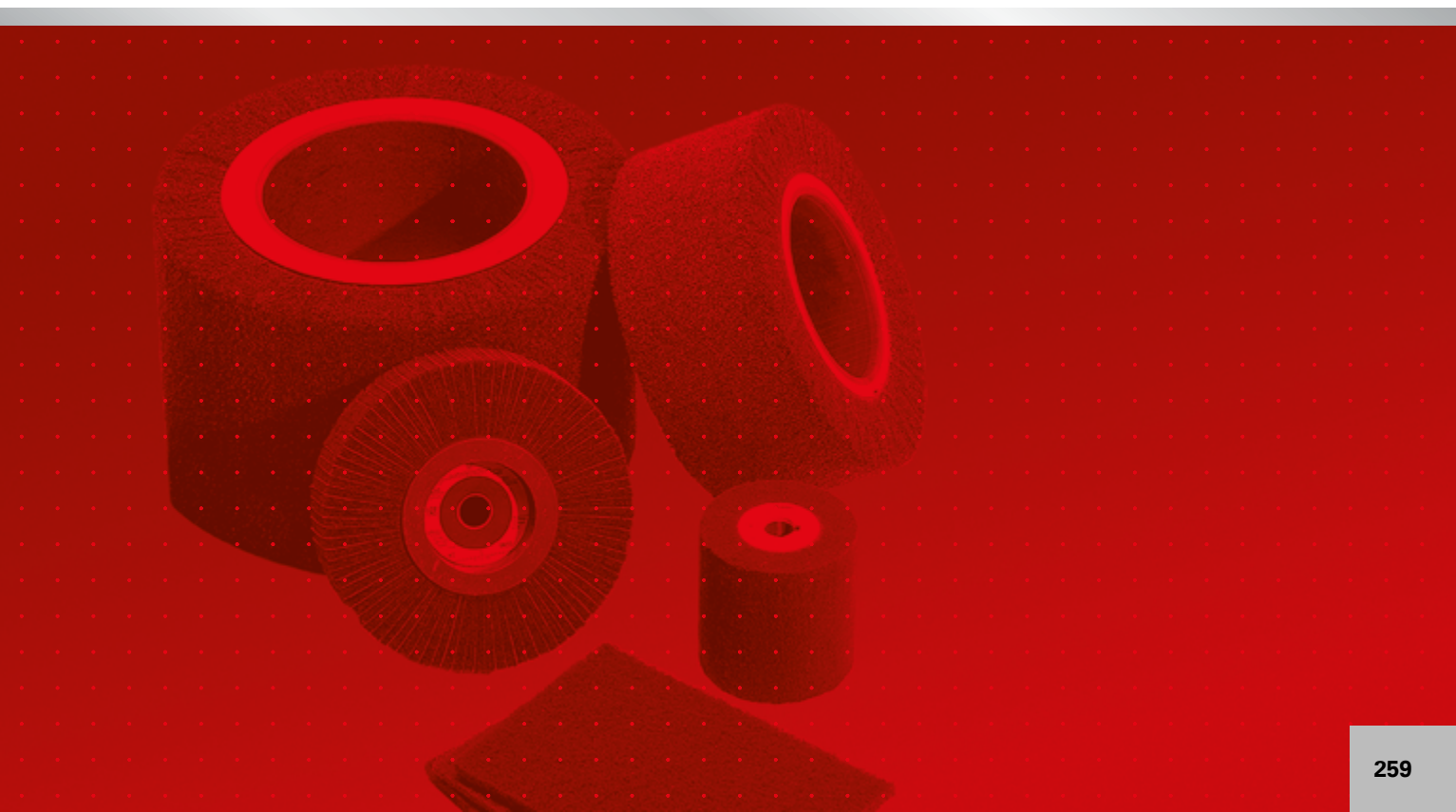

Information

LSL, Flap Wheels of abrasive cloth (tailor-made solution)

These wheels with various bore dimensions can be used on both hand-held and floor-stand type machines. The type LSL consists of individual flaps imbedded radially into a very substantial resin-based core. Please take note of the rotational direction!

Examples of application:

- preparation work
- deburring
- de-rusting
- prefinishing
- graining
- keying

LSL, Flap Wheels of abrasive cloth for angle grinder

Advantages:

- Fits onto standard angle grinders
- Replaces the use of shaft mounted flap wheels (where no straight grinder is available)
- No flange needed
- Ideal for welding seams on Stainless Steel (tanks)

Examples of application:

- de-rusting, removal of surface coatings and oxidized layers
- cleaning of welding seams
- grinding in the tank industry and construction of railings
- grinding in the assembling industry

Application info:

Only to be used on the periphery of the wheel

LSV, Grinding wheels of abrasive fleece (tailor-made solution)

These wheels with various bore dimensions can be used on both hand-held and floor-stand type machines. The LSV consists of abrasive impregnated fleece flaps. A special type of fleece gives flexibility to the tools which easily conforms to the individual work-piece profile.

Examples of application:

- matting
- conditioning
- polishing
- finishing
- final surface finishing

LSM, Flap wheels of abrasive fleece with abrasive cloth (tailor-made solution)

These wheels with various bore dimensions can be used on both hand-held and floor-stand type machines. Due to the combination of coated abrasive and abrasive fleece greater stock removal is achieved compared to the product type LSV. Please take note of the rotational direction!

Examples of application:

- preparation work
- de-rusting
- pre-finishing
- graining
- keying

LSL, flap wheels from abrasive cloth with screw thread for angle grinders

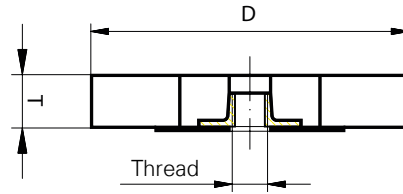

Ordering example: A2280125200040

v_{max.}: 80 m/s

NK = reg. Aluminium Oxide

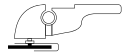

PG 10

Product number	Description	Grit	D mm	T mm	Thread	n recom. (1/min)	n max. (1/min)	recommended for Information on page 438		
A2280125200040	LSL 125020	NK 40	125	20	M14	9.600	12.200	① ② ③ ④ ⑤ ⑥ ⑦ ⑧	■	5
A2280125200040001	LSL 125020	NK 40	125	20	5/8"	9.600	12.200	① ② ③ ④ ⑤ ⑥ ⑦ ⑧	■	5
A2280125200060	LSL 125020	NK 60	125	20	M14	9.600	12.200	① ② ③ ④ ⑤ ⑥ ⑦ ⑧	■	5
A2280125200060001	LSL 125020	NK 60	125	20	5/8"	9.600	12.200	① ② ③ ④ ⑤ ⑥ ⑦ ⑧	■	5
A2280125200080	LSL 125020	NK 80	125	20	M14	9.600	12.200	① ② ③ ④ ⑤ ⑥ ⑦ ⑧	■	5
A2280125200080001	LSL 125020	NK 80	125	20	5/8"	9.600	12.200	① ② ③ ④ ⑤ ⑥ ⑦ ⑧	■	5
A2280125200120	LSL 125020	NK 120	125	20	M14	9.600	12.200	① ② ③ ④ ⑤ ⑥ ⑦ ⑧	■	5
A2280125200120001	LSL 125020	NK 120	125	20	5/8"	9.600	12.200	① ② ③ ④ ⑤ ⑥ ⑦ ⑧	■	5

Advantages:

- Fits onto standard angle grinders
- Replaces the use of shaft mounted flap wheels (where no straight grinder is available)
- No flange needed
- Ideal for welding seams on Stainless Steel (tanks)

Application examples:

- De-rusting, removal of surface coatings and oxidise layers
- Cleaning of welding seams
- Grinding in the tank industry
- Grinding in the assembling industry

Application info:

- Only to be used on the periphery of the wheel

Grinding, Polishing (flexible)

LSL, Flap Wheels of abrasive cloth, tailor-made solution

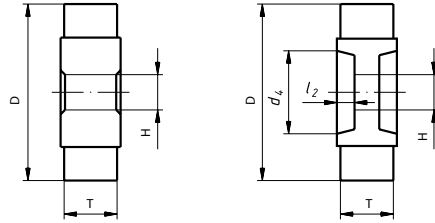

Ordering example: LSL 125025 NK 60 Bore 13

Minimum ordering quantity 25 pcs. per type

$v_{rec.}$: 30 m/s off-hand application

$v_{max.}$: 50 m/s for stationary machines

* for stationary machines

NK = reg. Aluminium Oxide

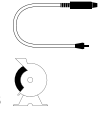

PG 10

Description	Grit	D mm	T mm	H mm	recess on both sides d_4 mm	recess on both sides l_2 mm	n recom. (1/min)	n max.* (1/min)	recommended for								▲	📦
									Information on page 438									
LSL 125025	NK 60	125	25	13-16-20	—	—	4.500	7.600	①	②	③	④	⑤	⑥	⑦	⑧	▲	
LSL 125025	NK 80	125	25	13-16-20	—	—	4.500	7.600	①	②	③	④	⑤	⑥	⑦	⑧	▲	
LSL 125025	NK 120	125	25	13-16-20	—	—	4.500	7.600	①	②	③	④	⑤	⑥	⑦	⑧	▲	
LSL 125025	NK 150	125	25	13-16-20	—	—	4.500	7.600	①	②	③	④	⑤	⑥	⑦	⑧	▲	
LSL 125025	NK 240	125	25	13-16-20	—	—	4.500	7.600	①	②	③	④	⑤	⑥	⑦	⑧	▲	
LSL 150050	NK 60	150	50	13-16-20	47	18	3.800	6.300	①	②	③	④	⑤	⑥	⑦	⑧	▲	
LSL 150050	NK 80	150	50	13-16-20	47	18	3.800	6.300	①	②	③	④	⑤	⑥	⑦	⑧	▲	
LSL 150050	NK 120	150	50	13-16-20	47	18	3.800	6.300	①	②	③	④	⑤	⑥	⑦	⑧	▲	
LSL 150050	NK 150	150	50	13-16-20	47	18	3.800	6.300	①	②	③	④	⑤	⑥	⑦	⑧	▲	
LSL 150050	NK 240	150	50	13-16-20	47	18	3.800	6.300	①	②	③	④	⑤	⑥	⑦	⑧	▲	
LSL 165050	NK 60	165	50	13-16-20	47	18	3.400	5.700	①	②	③	④	⑤	⑥	⑦	⑧	▲	
LSL 165050	NK 80	165	50	13-16-20	47	18	3.400	5.700	①	②	③	④	⑤	⑥	⑦	⑧	▲	
LSL 165050	NK 120	165	50	13-16-20	47	18	3.400	5.700	①	②	③	④	⑤	⑥	⑦	⑧	▲	
LSL 165050	NK 150	165	50	13-16-20	47	18	3.400	5.700	①	②	③	④	⑤	⑥	⑦	⑧	▲	
LSL 165050	NK 240	165	50	13-16-20	47	18	3.400	5.700	①	②	③	④	⑤	⑥	⑦	⑧	▲	
LSL 200025	NK 60	200	25	20-25-32	71	10	2.800	4.700	①	②	③	④	⑤	⑥	⑦	⑧	▲	
LSL 200025	NK 80	200	25	20-25-32	71	10	2.800	4.700	①	②	③	④	⑤	⑥	⑦	⑧	▲	
LSL 200025	NK 120	200	25	20-25-32	71	10	2.800	4.700	①	②	③	④	⑤	⑥	⑦	⑧	▲	
LSL 200025	NK 150	200	25	20-25-32	71	10	2.800	4.700	①	②	③	④	⑤	⑥	⑦	⑧	▲	
LSL 200025	NK 240	200	25	20-25-32	71	10	2.800	4.700	①	②	③	④	⑤	⑥	⑦	⑧	▲	
LSL 200050	NK 60	200	50	20-25-32	71	18	2.800	4.700	①	②	③	④	⑤	⑥	⑦	⑧	▲	
LSL 200050	NK 80	200	50	20-25-32	71	18	2.800	4.700	①	②	③	④	⑤	⑥	⑦	⑧	▲	
LSL 200050	NK 120	200	50	20-25-32	71	18	2.800	4.700	①	②	③	④	⑤	⑥	⑦	⑧	▲	
LSL 200050	NK 150	200	50	20-25-32	71	18	2.800	4.700	①	②	③	④	⑤	⑥	⑦	⑧	▲	
LSL 200050	NK 240	200	50	20-25-32	71	18	2.800	4.700	①	②	③	④	⑤	⑥	⑦	⑧	▲	

Other dimensions can be supplied on request – from 80 mm to max. 400 mm.

Grinding, Polishing (flexible)

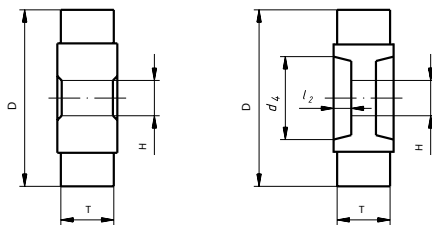
LSV, Grinding wheels of abrasive fleece, tailor-made solution

Ordering example: LSV 100050 A 104 W Bore 13

Minimum ordering quantity 25 pcs. per type

 $v_{max.}: 35 \text{ m/s}$

A = reg. Aluminium Oxide

C = Silicon carbide

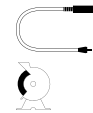
PG 10

Description	Grit	Quality	D mm	T mm	H mm	recess on both sides d ₄ mm	recess on both sides l ₂ mm	n recom. (1/min)	n max. (1/min)	recommended for								▲	☐
										Information on page 438									
LSV 100050	A 104 W	soft	100	50	13-16-20	—	—	3.000	6.000	1	2	3	4	5	6	7	8	▲	☐
LSV 100050	A 106 W	soft	100	50	13-16-20	—	—	3.000	6.000	1	2	3	4	5	6	7	8	▲	☐
LSV 100050	A 107 W	soft	100	50	13-16-20	—	—	3.000	6.000	1	2	3	4	5	6	7	8	▲	☐
LSV 100050	C 204 W	soft	100	50	13-16-20	—	—	3.000	6.000	1	2	3	4	5	6	7	8	▲	☐
LSV 100050	C 206 W	soft	100	50	13-16-20	—	—	3.000	6.000	1	2	3	4	5	6	7	8	▲	☐
LSV 100050	C 207 W	soft	100	50	13-16-20	—	—	3.000	6.000	1	2	3	4	5	6	7	8	▲	☐
LSV 100050	A 104 M	medium	100	50	13-16-20	—	—	3.000	6.000	1	2	3	4	5	6	7	8	▲	☐
LSV 100050	A 106 M	medium	100	50	13-16-20	—	—	3.000	6.000	1	2	3	4	5	6	7	8	▲	☐
LSV 100050	A 107 M	medium	100	50	13-16-20	—	—	3.000	6.000	1	2	3	4	5	6	7	8	▲	☐
LSV 100050	C 204 M	medium	100	50	13-16-20	—	—	3.000	6.000	1	2	3	4	5	6	7	8	▲	☐
LSV 100050	C 206 M	medium	100	50	13-16-20	—	—	3.000	6.000	1	2	3	4	5	6	7	8	▲	☐
LSV 100050	C 207 M	medium	100	50	13-16-20	—	—	3.000	6.000	1	2	3	4	5	6	7	8	▲	☐
LSV 100050	A 104 H	hard	100	50	13-16-20	—	—	3.000	6.000	1	2	3	4	5	6	7	8	▲	☐
LSV 100050	A 106 H	hard	100	50	13-16-20	—	—	3.000	6.000	1	2	3	4	5	6	7	8	▲	☐
LSV 100050	A 107 H	hard	100	50	13-16-20	—	—	3.000	6.000	1	2	3	4	5	6	7	8	▲	☐
LSV 100050	C 204 H	hard	100	50	13-16-20	—	—	3.000	6.000	1	2	3	4	5	6	7	8	▲	☐
LSV 100050	C 206 H	hard	100	50	13-16-20	—	—	3.000	6.000	1	2	3	4	5	6	7	8	▲	☐
LSV 100050	C 207 H	hard	100	50	13-16-20	—	—	3.000	6.000	1	2	3	4	5	6	7	8	▲	☐
LSV 150050	A 104 W	soft	150	50	13-16-20	47	18	2.000	4.000	1	2	3	4	5	6	7	8	▲	☐
LSV 150050	A 106 W	soft	150	50	13-16-20	47	18	2.000	4.000	1	2	3	4	5	6	7	8	▲	☐
LSV 150050	A 107 W	soft	150	50	13-16-20	47	18	2.000	4.000	1	2	3	4	5	6	7	8	▲	☐
LSV 150050	C 204 W	soft	150	50	13-16-20	47	18	2.000	4.000	1	2	3	4	5	6	7	8	▲	☐
LSV 150050	C 206 W	soft	150	50	13-16-20	47	18	2.000	4.000	1	2	3	4	5	6	7	8	▲	☐
LSV 150050	C 207 W	soft	150	50	13-16-20	47	18	2.000	4.000	1	2	3	4	5	6	7	8	▲	☐
LSV 150050	A 104 M	medium	150	50	13-16-20	47	18	2.000	4.000	1	2	3	4	5	6	7	8	▲	☐
LSV 150050	A 106 M	medium	150	50	13-16-20	47	18	2.000	4.000	1	2	3	4	5	6	7	8	▲	☐
LSV 150050	A 107 M	medium	150	50	13-16-20	47	18	2.000	4.000	1	2	3	4	5	6	7	8	▲	☐
LSV 150050	C 204 M	medium	150	50	13-16-20	47	18	2.000	4.000	1	2	3	4	5	6	7	8	▲	☐
LSV 150050	C 206 M	medium	150	50	13-16-20	47	18	2.000	4.000	1	2	3	4	5	6	7	8	▲	☐
LSV 150050	C 207 M	medium	150	50	13-16-20	47	18	2.000	4.000	1	2	3	4	5	6	7	8	▲	☐
LSV 150050	A 104 H	hard	150	50	13-16-20	47	18	2.000	4.000	1	2	3	4	5	6	7	8	▲	☐
LSV 150050	A 106 H	hard	150	50	13-16-20	47	18	2.000	4.000	1	2	3	4	5	6	7	8	▲	☐
LSV 150050	A 107 H	hard	150	50	13-16-20	47	18	2.000	4.000	1	2	3	4	5	6	7	8	▲	☐
LSV 150050	C 204 H	hard	150	50	13-16-20	47	18	2.000	4.000	1	2	3	4	5	6	7	8	▲	☐
LSV 150050	C 206 H	hard	150	50	13-16-20	47	18	2.000	4.000	1	2	3	4	5	6	7	8	▲	☐

Other dimensions, bores or qualities, e.g. "very hard" or "Poly Urethane-foamed" are available on request. Possible diameters 80 mm to max. 400 mm.

LSV, Grinding wheels of abrasive fleece, tailor-made solution

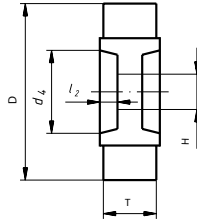
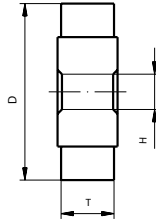

Ordering example: LSV 150050 C 207 H Bore 13

Minimum ordering quantity 25 pcs. per type

v_{max.}: 35 m/s

A = reg. Aluminium Oxide

C = Silicon carbide

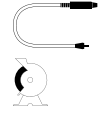

PG 10

Grinding, Polishing (flexible)

Description	Grit	Quality	D mm	T mm	H mm	recess on both sides d ₄ mm	recess on both sides l ₂ mm	n recom. (1/min)	n max. (1/min)	recommended for								▲	📦
										Information on page 438									
LSV 150050	C 207 H	hard	150	50	13-16-20	47	18	2.000	4.000	1	2	3	4	5	6	7	8	▲	
LSV 160050	A 104 W	soft	160	50	13-16-20	47	18	1.900	3.800	1	2	3	4	5	6	7	8	▲	
LSV 160050	A 106 W	soft	160	50	13-16-20	47	18	1.900	3.800	1	2	3	4	5	6	7	8	▲	
LSV 160050	A 107 W	soft	160	50	13-16-20	47	18	1.900	3.800	1	2	3	4	5	6	7	8	▲	
LSV 160050	C 204 W	soft	160	50	13-16-20	47	18	1.900	3.800	1	2	3	4	5	6	7	8	▲	
LSV 160050	C 206 W	soft	160	50	13-16-20	47	18	1.900	3.800	1	2	3	4	5	6	7	8	▲	
LSV 160050	C 207 W	soft	160	50	13-16-20	47	18	1.900	3.800	1	2	3	4	5	6	7	8	▲	
LSV 160050	A 104 M	medium	160	50	13-16-20	47	18	1.900	3.800	1	2	3	4	5	6	7	8	▲	
LSV 160050	A 106 M	medium	160	50	13-16-20	47	18	1.900	3.800	1	2	3	4	5	6	7	8	▲	
LSV 160050	A 107 M	medium	160	50	13-16-20	47	18	1.900	3.800	1	2	3	4	5	6	7	8	▲	
LSV 160050	C 204 M	medium	160	50	13-16-20	47	18	1.900	3.800	1	2	3	4	5	6	7	8	▲	
LSV 160050	C 206 M	medium	160	50	13-16-20	47	18	1.900	3.800	1	2	3	4	5	6	7	8	▲	
LSV 160050	C 207 M	medium	160	50	13-16-20	47	18	1.900	3.800	1	2	3	4	5	6	7	8	▲	
LSV 160050	A 104 H	hard	160	50	13-16-20	47	18	1.900	3.800	1	2	3	4	5	6	7	8	▲	
LSV 160050	A 106 H	hard	160	50	13-16-20	47	18	1.900	3.800	1	2	3	4	5	6	7	8	▲	
LSV 160050	A 107 H	hard	160	50	13-16-20	47	18	1.900	3.800	1	2	3	4	5	6	7	8	▲	
LSV 160050	C 204 H	hard	160	50	13-16-20	47	18	1.900	3.800	1	2	3	4	5	6	7	8	▲	
LSV 160050	C 206 H	hard	160	50	13-16-20	47	18	1.900	3.800	1	2	3	4	5	6	7	8	▲	
LSV 160050	C 207 H	hard	160	50	13-16-20	47	18	1.900	3.800	1	2	3	4	5	6	7	8	▲	
LSV 200025	A 104 W	soft	200	25	20-25-32	71	10	1.500	3.000	1	2	3	4	5	6	7	8	▲	
LSV 200025	A 106 W	soft	200	25	20-25-32	71	10	1.500	3.000	1	2	3	4	5	6	7	8	▲	
LSV 200025	A 107 W	soft	200	25	20-25-32	71	10	1.500	3.000	1	2	3	4	5	6	7	8	▲	
LSV 200025	C 204 W	soft	200	25	20-25-32	71	10	1.500	3.000	1	2	3	4	5	6	7	8	▲	
LSV 200025	C 206 W	soft	200	25	20-25-32	71	10	1.500	3.000	1	2	3	4	5	6	7	8	▲	
LSV 200025	C 207 W	soft	200	25	20-25-32	71	10	1.500	3.000	1	2	3	4	5	6	7	8	▲	
LSV 200025	A 104 M	medium	200	25	20-25-32	71	10	1.500	3.000	1	2	3	4	5	6	7	8	▲	
LSV 200025	A 106 M	medium	200	25	20-25-32	71	10	1.500	3.000	1	2	3	4	5	6	7	8	▲	
LSV 200025	A 107 M	medium	200	25	20-25-32	71	10	1.500	3.000	1	2	3	4	5	6	7	8	▲	
LSV 200025	C 204 M	medium	200	25	20-25-32	71	10	1.500	3.000	1	2	3	4	5	6	7	8	▲	
LSV 200025	C 206 M	medium	200	25	20-25-32	71	10	1.500	3.000	1	2	3	4	5	6	7	8	▲	
LSV 200025	C 207 M	medium	200	25	20-25-32	71	10	1.500	3.000	1	2	3	4	5	6	7	8	▲	
LSV 200025	A 104 H	hard	200	25	20-25-32	71	10	1.500	3.000	1	2	3	4	5	6	7	8	▲	
LSV 200025	A 106 H	hard	200	25	20-25-32	71	10	1.500	3.000	1	2	3	4	5	6	7	8	▲	
LSV 200025	A 107 H	hard	200	25	20-25-32	71	10	1.500	3.000	1	2	3	4	5	6	7	8	▲	
LSV 200025	C 204 H	hard	200	25	20-25-32	71	10	1.500	3.000	1	2	3	4	5	6	7	8	▲	

Other dimensions, bores or qualities, e.g. "very hard" or "Poly Urethane-foamed" are available on request. Possible diameters 80 mm to max. 400 mm.

LSV, Grinding wheels of abrasive fleece, tailor-made solution

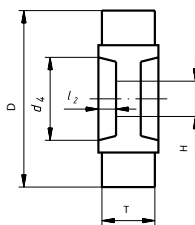
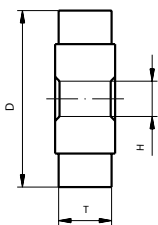

Ordering example: LSV 200025 C 206 H Bore 20

Minimum ordering quantity 25 pcs. per type

v_{max.}: 35 m/s

A = reg. Aluminium Oxide

C = Silicon carbide

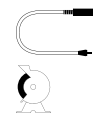

PG 10

Description	Grit	Quality	D mm	T mm	H mm	recess on both sides d ₄ mm	recess on both sides l ₂ mm	n recom. (1/min)	n max. (1/min)	recommended for								▲	☐
										Information on page 438									
LSV 200025	C 206 H	hard	200	25	20-25-32	71	10	1.500	3.000	1	2	3	4	5	6	7	8	▲	☐
LSV 200025	C 207 H	hard	200	25	20-25-32	71	10	1.500	3.000	1	2	3	4	5	6	7	8	▲	☐
LSV 200050	A 104 W	soft	200	50	20-25-32	71	18	1.500	3.000	1	2	3	4	5	6	7	8	▲	☐
LSV 200050	A 106 W	soft	200	50	20-25-32	71	18	1.500	3.000	1	2	3	4	5	6	7	8	▲	☐
LSV 200050	A 107 W	soft	200	50	20-25-32	71	18	1.500	3.000	1	2	3	4	5	6	7	8	▲	☐
LSV 200050	C 204 W	soft	200	50	20-25-32	71	18	1.500	3.000	1	2	3	4	5	6	7	8	▲	☐
LSV 200050	C 206 W	soft	200	50	20-25-32	71	18	1.500	3.000	1	2	3	4	5	6	7	8	▲	☐
LSV 200050	C 207 W	soft	200	50	20-25-32	71	18	1.500	3.000	1	2	3	4	5	6	7	8	▲	☐
LSV 200050	A 104 M	medium	200	50	20-25-32	71	18	1.500	3.000	1	2	3	4	5	6	7	8	▲	☐
LSV 200050	A 106 M	medium	200	50	20-25-32	71	18	1.500	3.000	1	2	3	4	5	6	7	8	▲	☐
LSV 200050	A 107 M	medium	200	50	20-25-32	71	18	1.500	3.000	1	2	3	4	5	6	7	8	▲	☐
LSV 200050	C 204 M	medium	200	50	20-25-32	71	18	1.500	3.000	1	2	3	4	5	6	7	8	▲	☐
LSV 200050	C 206 M	medium	200	50	20-25-32	71	18	1.500	3.000	1	2	3	4	5	6	7	8	▲	☐
LSV 200050	C 207 M	medium	200	50	20-25-32	71	18	1.500	3.000	1	2	3	4	5	6	7	8	▲	☐
LSV 200050	A 104 H	hard	200	50	20-25-32	71	18	1.500	3.000	1	2	3	4	5	6	7	8	▲	☐
LSV 200050	A 106 H	hard	200	50	20-25-32	71	18	1.500	3.000	1	2	3	4	5	6	7	8	▲	☐
LSV 200050	A 107 H	hard	200	50	20-25-32	71	18	1.500	3.000	1	2	3	4	5	6	7	8	▲	☐
LSV 200050	C 204 H	hard	200	50	20-25-32	71	18	1.500	3.000	1	2	3	4	5	6	7	8	▲	☐
LSV 200050	C 206 H	hard	200	50	20-25-32	71	18	1.500	3.000	1	2	3	4	5	6	7	8	▲	☐
LSV 200050	C 207 H	hard	200	50	20-25-32	71	18	1.500	3.000	1	2	3	4	5	6	7	8	▲	☐

Other dimensions, bores or qualities, e.g. "very hard" or "Poly Urethane-foamed" are available on request. Possible diameters 80 mm to max. 400 mm.

Grinding, Polishing (flexible)

LSM, Flap wheels of abrasive fleece with abrasive cloth, tailor-made solution

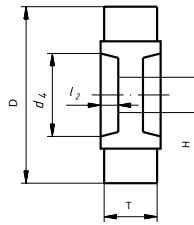
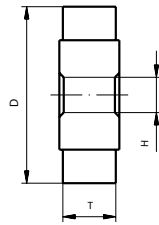

Ordering example: LSM 080050 A 104/80 H Bore 10

Minimum ordering quantity 25 pcs. per type

v_{max.}: 35 m/s

A = reg. Aluminium Oxide

C = Silicon carbide

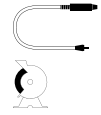

PG 10

Description	Grit	D mm	T mm	H mm	recess on both sides d ₄ mm	recess on both sides l ₂ mm	n recom. (1/min)	n max.* (1/min)	recommended for								▲	☐
									Information on page 438									
LSM 080050	A104/80	80	50	10-13-16	—	—	3.800	7.600	1	2	3	4	5	6	7	8	▲	☐
LSM 080050	A106/150	80	50	10-13-16	—	—	3.800	7.600	1	2	3	4	5	6	7	8	▲	☐
LSM 080050	A107/240	80	50	10-13-16	—	—	3.800	7.600	1	2	3	4	5	6	7	8	▲	☐
LSM 080050	C 204/80	80	50	10-13-16	—	—	3.800	7.600	1	2	3	4	5	6	7	8	▲	☐
LSM 080050	C 206/150	80	50	10-13-16	—	—	3.800	7.600	1	2	3	4	5	6	7	8	▲	☐
LSM 080050	C 207/240	80	50	10-13-16	—	—	3.800	7.600	1	2	3	4	5	6	7	8	▲	☐
LSM 150050	A104/80	150	50	13-16-20	47	18	2.000	4.000	1	2	3	4	5	6	7	8	▲	☐
LSM 150050	A106/150	150	50	13-16-20	47	18	2.000	4.000	1	2	3	4	5	6	7	8	▲	☐
LSM 150050	A107/240	150	50	13-16-20	47	18	2.000	4.000	1	2	3	4	5	6	7	8	▲	☐
LSM 150050	C 204/80	150	50	13-16-20	47	18	2.000	4.000	1	2	3	4	5	6	7	8	▲	☐
LSM 150050	C 206/150	150	50	13-16-20	47	18	2.000	4.000	1	2	3	4	5	6	7	8	▲	☐
LSM 150050	C 207/240	150	50	13-16-20	47	18	2.000	4.000	1	2	3	4	5	6	7	8	▲	☐
LSM 160050	A104/80	160	50	13-16-20	47	18	1.900	3.800	1	2	3	4	5	6	7	8	▲	☐
LSM 160050	A106/150	160	50	13-16-20	47	18	1.900	3.800	1	2	3	4	5	6	7	8	▲	☐
LSM 160050	A107/240	160	50	13-16-20	47	18	1.900	3.800	1	2	3	4	5	6	7	8	▲	☐
LSM 160050	C 204/80	160	50	13-16-20	47	18	1.900	3.800	1	2	3	4	5	6	7	8	▲	☐
LSM 160050	C 206/150	160	50	13-16-20	47	18	1.900	3.800	1	2	3	4	5	6	7	8	▲	☐
LSM 160050	C 207/240	160	50	13-16-20	47	18	1.900	3.800	1	2	3	4	5	6	7	8	▲	☐
LSM 200050	A104/80	200	50	20-25-32	71	18	1.500	3.000	1	2	3	4	5	6	7	8	▲	☐
LSM 200050	A106/150	200	50	20-25-32	71	18	1.500	3.000	1	2	3	4	5	6	7	8	▲	☐
LSM 200050	A107/240	200	50	20-25-32	71	18	1.500	3.000	1	2	3	4	5	6	7	8	▲	☐
LSM 200050	C 204/80	200	50	20-25-32	71	18	1.500	3.000	1	2	3	4	5	6	7	8	▲	☐
LSM 200050	C 206/150	200	50	20-25-32	71	18	1.500	3.000	1	2	3	4	5	6	7	8	▲	☐
LSM 200050	C 207/240	200	50	20-25-32	71	18	1.500	3.000	1	2	3	4	5	6	7	8	▲	☐

Other dimensions can be supplied on request – from 80 mm to max. 400 mm.

Grinding, Polishing (flexible)

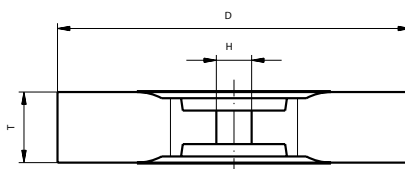
FRV, Mops of abrasive fleece

Ordering example: FRV 200050 A 104 Bore 20

Minimum ordering quantity 25 pcs. per type

A = reg. Aluminium Oxide

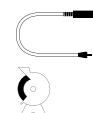
PG 10

Description	Grit	Quality	D mm	T mm	H mm	n recom. (1/min)	n max.* (1/min)	recommended for Information on page 438		
FRV 200050	A 104	medium	200	50	20-25-32	1.400	1.900	① ② ③ ④ ⑤ ⑥ ⑦ ⑧	▲	
FRV 200050	A 106	fine	200	50	20-25-32	1.400	1.900	① ② ③ ④ ⑤ ⑥ ⑦ ⑧	▲	
FRV 200050	A 107	very fine	200	50	20-25-32	1.400	1.900	① ② ③ ④ ⑤ ⑥ ⑦ ⑧	▲	
FRV 250050	A 104	medium	250	50	20-25-32	1.100	1.500	① ② ③ ④ ⑤ ⑥ ⑦ ⑧	▲	
FRV 250050	A 106	fine	250	50	20-25-32	1.100	1.500	① ② ③ ④ ⑤ ⑥ ⑦ ⑧	▲	
FRV 250050	A 107	very fine	250	50	20-25-32	1.100	1.500	① ② ③ ④ ⑤ ⑥ ⑦ ⑧	▲	
FRV 300060	A 104	medium	300	60	20-25-32	900	1.200	① ② ③ ④ ⑤ ⑥ ⑦ ⑧	▲	
FRV 300060	A 106	fine	300	60	20-25-32	900	1.200	① ② ③ ④ ⑤ ⑥ ⑦ ⑧	▲	
FRV 300060	A 107	very fine	300	60	20-25-32	900	1.200	① ② ③ ④ ⑤ ⑥ ⑦ ⑧	▲	

Grinding, Polishing (flexible)

LUKAS Fleece Mops are manufactured from abrasive fleece and are used when a satin polish is required on stainless, chrome, nickel and non ferrous metals. They are also ideal for cleaning-up and enhancing painted and varnished surfaces in the wood and plastic industries.

Furthermore, they are suited to the manufacture of stainless and aluminium containers supplied to the food industry. The ideal operating speed lies between 10 – 20 m/s and the fleece mops should be used with little pressure. They can be used with or without coolant. Operating with coolant extends the life of the fleece mop. When using water as a coolant a matt surface is achieved; oil produces a satin finish. LUKAS Fleece Mops can be clamped together on a single spindle thus giving the overall width required.

Flap rolls

196	Qualities and Applications
270	General Information
271	Flap rolls of abrasive cloth, LWL
272	Flap rolls of abrasive fleece, LWV
273	Flap rolls of abrasive fleece/abrasive cloth combination, LWM
274	Sinus-Abrasive rolls of abrasive fleece, LWF
275	Conditioning machine

Product line marking

The product lines are illustrated by star symbols at the top of the table; please refer to page **14** and **15**.

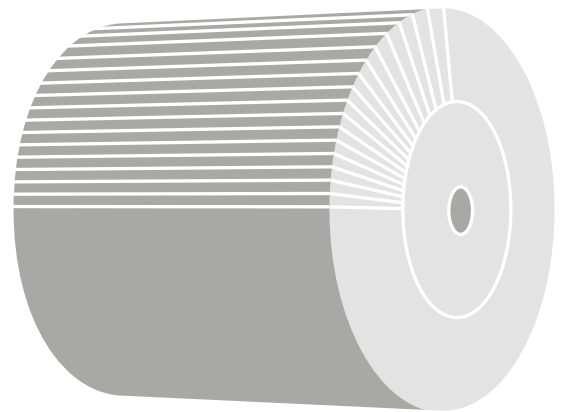

Grinding, Polishing
(flexible)

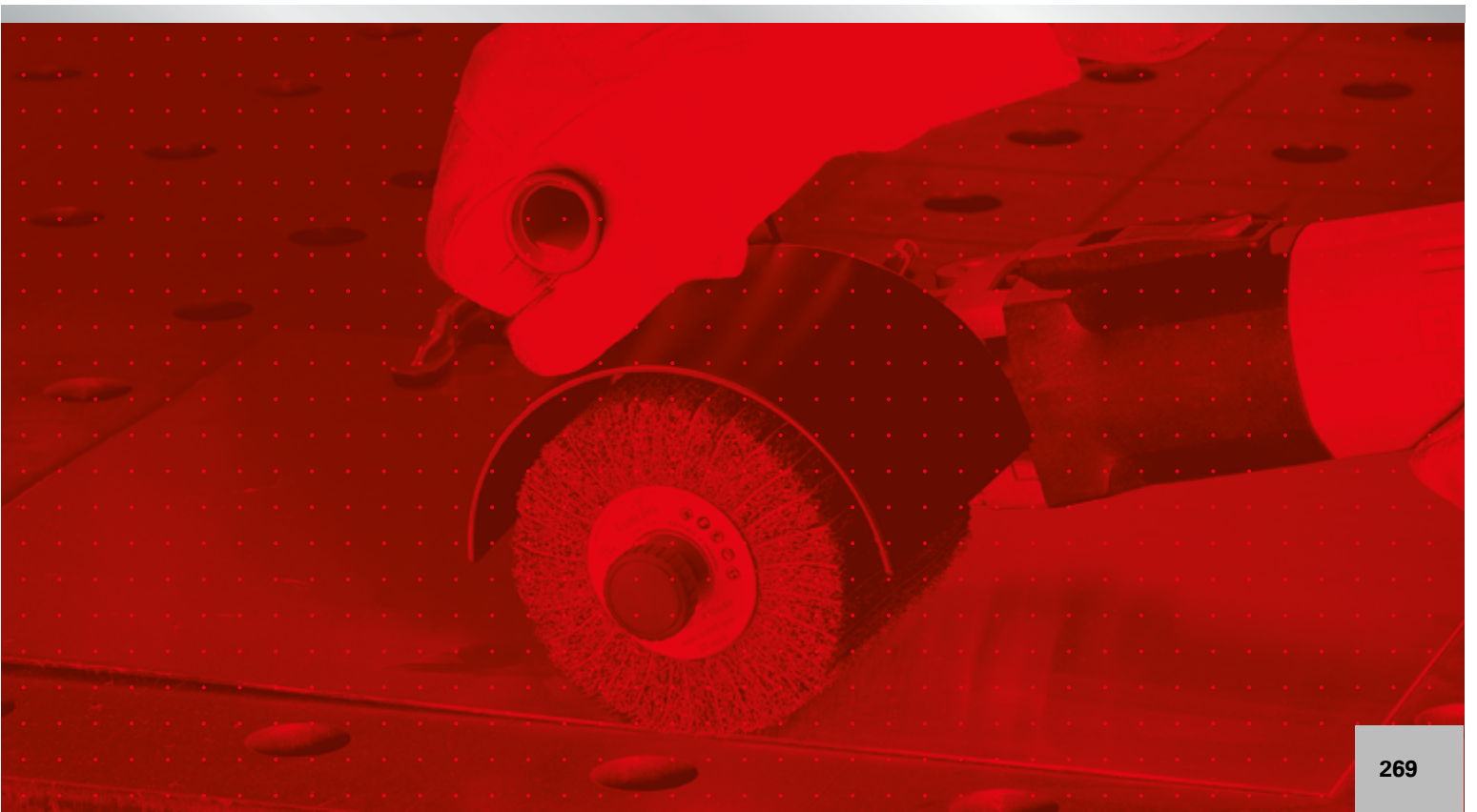

Information

General

These rolls have a nineteen mm bore with four keyways; they are used on hand-held surface conditioning machines.

LWL, Flap rolls of abrasive cloth for conditioning machines

These tools consist of individual flaps which are radially embedded into a resin core. Please take note of the rotational direction!

Examples of application:

- preparation work
- deburring
- de-rusting
- pre-finishing
- graining
- keying

LWV, Flap rolls of abrasive fleece for conditioning machines

This product type consists of abrasive fleece flaps. The special fleece gives the tool flexibility and conforms to the individual workpiece profile.

Examples of application:

- matting
- conditioning
- polishing
- finishing
- final finishing of the surface

LWF, Sinus-Abrasive rolls of abrasive fleece for conditioning machines

These tools are manufactured from strips of abrasive fleece which are wound in a wave pattern around the core. This configuration achieves an unblemished grained matt surface finish. The special fleece makes the LWF flexible and conforms to the individual workpiece profile.

Examples of application:

- matting
- conditioning
- polishing
- finishing
- fine surface finishing

LWM, Flap rolls of abrasive fleece with abrasive cloth insert for conditioning machines

Due to the combination of coated abrasive and abrasive fleece, greater stock removal is achieved compared to the product type LWV. Please take note of the rotational direction!

Examples of application:

- preparation work
- de-rusting
- pre-finishing
- graining
- keying

LWM, flap rolls using TF material

These rolls are supplied with a 19 mm bore and four key-ways, and are particularly suited for stainless steel. Please take note of the rotational direction!

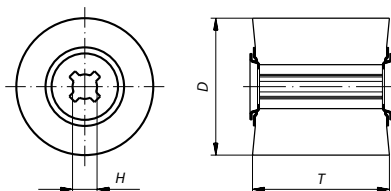
LWL, Flap rolls of abrasive cloth for conditioning machines

Ordering example: A22801001000040

NK = reg. Aluminium Oxide

Machines to suit: page 275.

PG 10

Product number	Description	Grit	D mm	T mm	H mm	n recom. (1/min)	n max. (1/min)	recommended for Information on page 438		
A2280100500040	LWL 100050	NK 40	100	50	19	3.700	6.000	① ② ③ ④ ⑤ ⑥ ⑦ ⑧	■	2
A2280100500060	LWL 100050	NK 60	100	50	19	3.700	6.000	① ② ③ ④ ⑤ ⑥ ⑦ ⑧	■	2
A2280100500080	LWL 100050	NK 80	100	50	19	3.700	6.000	① ② ③ ④ ⑤ ⑥ ⑦ ⑧	■	2
A22801001000040	LWL 100100	NK 40	100	100	19	3.700	6.000	① ② ③ ④ ⑤ ⑥ ⑦ ⑧	■	1
A22801001000060	LWL 100100	NK 60	100	100	19	3.700	6.000	① ② ③ ④ ⑤ ⑥ ⑦ ⑧	■	1
A22801001000080	LWL 100100	NK 80	100	100	19	3.700	6.000	① ② ③ ④ ⑤ ⑥ ⑦ ⑧	■	1

Grinding, Polishing (flexible)

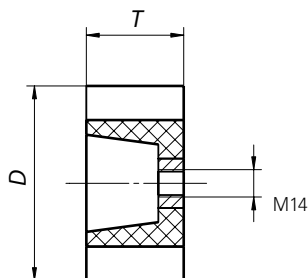
LWL, Flap rolls of abrasive cloth with thread

Ordering example: A2280100501060

NK = reg. Aluminium Oxide

Suitable for controlled angle grinders.

PG 10

Product number	Description	Grit	D mm	T mm	Thread	n recom. (1/min)	n max. (1/min)	recommended for Information on page 438		
A2280100501060	LWL 100050	NK 60	100	50	M 14	3.700	6.000	① ② ③ ④ ⑤ ⑥ ⑦ ⑧	■	2
A2280100501080	LWL 100050	NK 80	100	50	M 14	3.700	6.000	① ② ③ ④ ⑤ ⑥ ⑦ ⑧	■	2

LWV, Flap rolls of abrasive fleece for conditioning machines

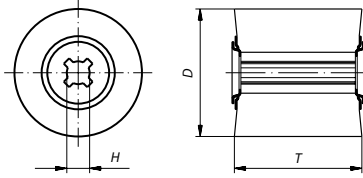

Ordering example: A22861001000104

A = reg. Aluminium Oxide

Machines to suit: page 275.

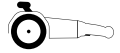

PG 10

Product number	Description	Grit	D mm	T mm	H mm	n recom. (1/min)	n max. (1/min)	recommended for Information on page 438		
A2286100500104	LWV 100050	A 104	100	50	19	2.800	6.000	① ② ③ ④ ⑤ ⑥ ⑦ ⑧	■	2
A2286100500106	LWV 100050	A 106	100	50	19	2.800	6.000	① ② ③ ④ ⑤ ⑥ ⑦ ⑧	■	2
A2286100500107	LWV 100050	A 107	100	50	19	2.800	6.000	① ② ③ ④ ⑤ ⑥ ⑦ ⑧	■	2
A22861001000104	LWV 100100	A 104	100	100	19	2.800	6.000	① ② ③ ④ ⑤ ⑥ ⑦ ⑧	■	1
A22861001000106	LWV 100100	A 106	100	100	19	2.800	6.000	① ② ③ ④ ⑤ ⑥ ⑦ ⑧	■	1
A22861001000107	LWV 100100	A 107	100	100	19	2.800	6.000	① ② ③ ④ ⑤ ⑥ ⑦ ⑧	■	1

Grinding, Polishing
(flexible)

LWV, Flap rolls of abrasive fleece with thread

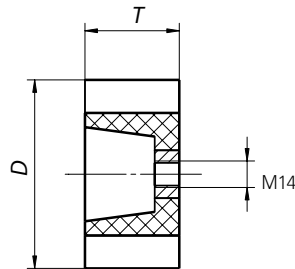

Ordering example: A2286100501104

A = reg. Aluminium Oxide

Suitable for controlled angle grinders.

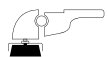

PG 10

Product number	Description	Grit	D mm	T mm	Thread	n recom. (1/min)	n max. (1/min)	recommended for Information on page 438		
A2286100501104	LWV 100050	A 104	100	50	M 14	2.800	6.000	① ② ③ ④ ⑤ ⑥ ⑦ ⑧	■	2
A2286100501106	LWV 100050	A 106	100	50	M 14	2.800	6.000	① ② ③ ④ ⑤ ⑥ ⑦ ⑧	■	2
A2286100501107	LWV 100050	A 107	100	50	M 14	2.800	6.000	① ② ③ ④ ⑤ ⑥ ⑦ ⑧	■	2

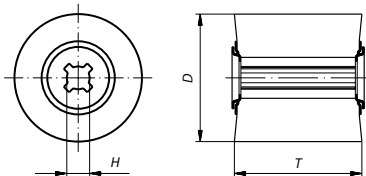
LWM, Flap rolls of abrasive fleece/abrasive cloth combination

Ordering example: A22881001000120

TF = Special quality for INOX

Machines to suit: page 275.

PG 10

Product number	Description	Grit	D mm	T mm	H mm	n recom. (1/min)	n max. (1/min)	recommended for Information on page 438		
A22881001000120	LWM 100100	TF 120/80	100	100	19	2.800	6.000	① ② ③ ④ ⑤ ⑥ ⑦ ⑧	■	1

Ideal for surface finishing of metalsheet components such as stainless steel sinks and containers

Grinding, Polishing (flexible)

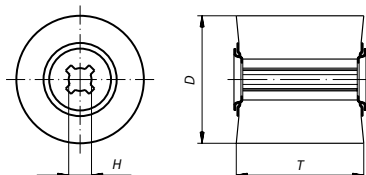
LWM, Flap rolls of abrasive fleece/abrasive cloth combination

Ordering example: A22881001000104

A = reg. Aluminium Oxide

Machines to suit: page 275.

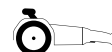
PG 10

Product number	Description	Grit	D mm	T mm	H mm	n recom. (1/min)	n max. (1/min)	recommended for Information on page 438		
A22881005000104	LWM 100050	A 104/80	100	50	19	2.800	6.000	① ② ③ ④ ⑤ ⑥ ⑦ ⑧	■	2
A22881005000106	LWM 100050	A 106/150	100	50	19	2.800	6.000	① ② ③ ④ ⑤ ⑥ ⑦ ⑧	■	2
A22881005000107	LWM 100050	A 107/240	100	50	19	2.800	6.000	① ② ③ ④ ⑤ ⑥ ⑦ ⑧	■	2
A22881001000104	LWM 100100	A 104/80	100	100	19	2.800	6.000	① ② ③ ④ ⑤ ⑥ ⑦ ⑧	■	1
A22881001000106	LWM 100100	A 106/150	100	100	19	2.800	6.000	① ② ③ ④ ⑤ ⑥ ⑦ ⑧	■	1
A22881001000107	LWM 100100	A 107/240	100	100	19	2.800	6.000	① ② ③ ④ ⑤ ⑥ ⑦ ⑧	■	1

LWM, Flap rolls of abrasive fleece/abrasive cloth combination with thread

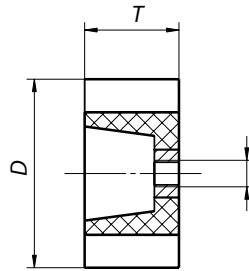

Ordering example: A2288100501104

A = reg. Aluminium Oxide

Suitable for controlled angle grinders.

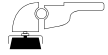

PG 10

Product number	Description	Grit	D mm	T mm	Thread	n recom. (1/min)	n max. (1/min)	recommended for		
A2288100501104	LWM 100050	A 104/80	100	50	M 14	2.800	6.000	① ② ③ ④ ⑤ ⑥ ⑦ ⑧	■	2
A2288100501106	LWM 100050	A 106/150	100	50	M 14	2.800	6.000	① ② ③ ④ ⑤ ⑥ ⑦ ⑧	■	2

Grinding, Polishing (flexible)

LWF, Sinus-Abrasive rolls of abrasive fleece for conditioning machines

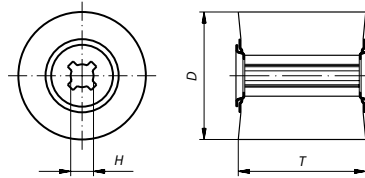

Ordering example: A22811001000104

A = reg. Aluminium Oxide

C = Silicon carbide

Machines to suit: page 275.

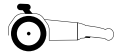

PG 10

Product number	Description	Grit	D mm	T mm	H mm	n recom. (1/min)	n max. (1/min)	recommended for		
A2281100500104	LWF 100050	A 104	100	50	19	2.800	3.800	① ② ③ ④ ⑤ ⑥ ⑦ ⑧	■	2
A2281100500106	LWF 100050	A 106	100	50	19	2.800	3.800	① ② ③ ④ ⑤ ⑥ ⑦ ⑧	■	2
A22811001000104	LWF 100100	A 104	100	100	19	2.800	3.800	① ② ③ ④ ⑤ ⑥ ⑦ ⑧	■	1
A22811001000106	LWF 100100	A 106	100	100	19	2.800	3.800	① ② ③ ④ ⑤ ⑥ ⑦ ⑧	■	1
A2281100500208	LWF 100050	C 208	100	50	19	2.800	3.800	① ② ③ ④ ⑤ ⑥ ⑦ ⑧ ⑨	■	2
A22811001000208	LWF 100100	C 208	100	100	19	2.800	3.800	① ② ③ ④ ⑤ ⑥ ⑦ ⑧ ⑨	■	1

Conditioning machine

★★☆



Ordering example: A3995ESM1310

Weight: approx. 2,8 kg

PG 15

Product number	Description	Idle speed min -1	Power input W	Max. Ø mm tool diameter	Tool width mm	Hole size mm	recommended for Information on page 438		
A3995ESM1310	ESM 1310	1.300-3.050	1.300	120	100	19		■	1

In conjunction with the appropriate tool, ideal for:

- Satin finishing
- Conditioning
- Polishing
- Brushing
- Smoothing
- Deburring
- Matt finishing

Special features:

- Highly resilient motor (stable)
- Dual gear reduction (long service life)
- Dust-protected bearings (low wear)
- In conjunction with the optimal tooling, a shadow free and uniform surface can be achieved on metal, wood and plastic.

Electronic control:

- Soft start
- Infinitely variable speed control
- Temperature and overload cut-off

Grinding, Polishing (flexible)

Abrasive Bands and Mandrels

196 Qualities and Applications

278 General Information

279 Abrasive Bands, cylindrical

285 Mandrels for cylindrical shape

286 Abrasive Bands, cylindrical, unlined

286 Mandrels for cylindrical shape, soft

287 Abrasive Bands, conical

287 Mandrels for conical shape

288 Grinding rolls

288 Mounting device for grinding rolls

289 Linishing belts

369 Power tools

Product line marking

The product lines are illustrated by star symbols at the top of the table; please refer to page **14** and **15**.



Grinding, Polishing
(flexible)

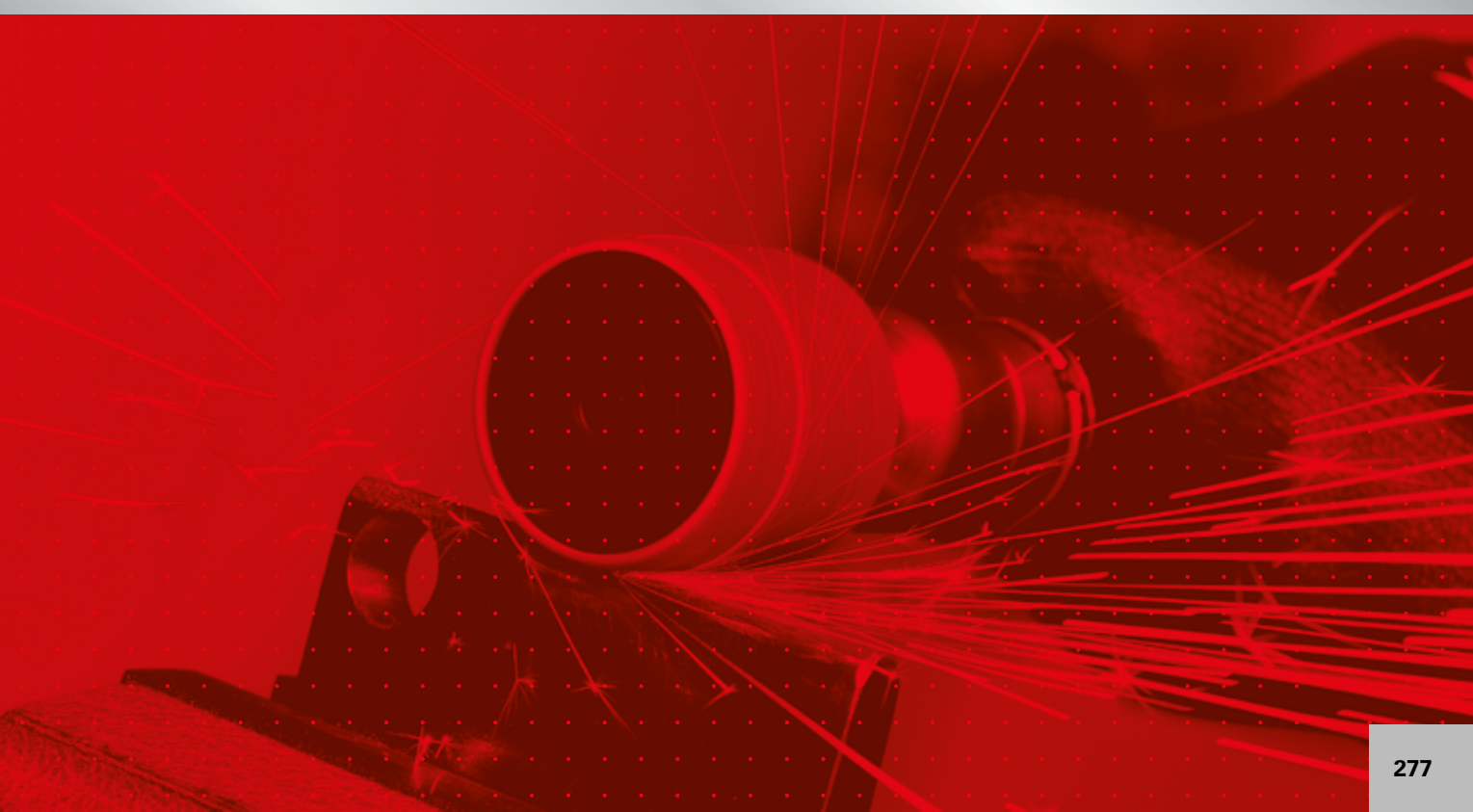

Information

SBZY, Abrasive Bands, cylindrical

LUKAS offers a wide selection of abrasive bands and the corresponding mandrel. They are available in numerous dimensions and qualities. Abrasive bands are manufactured from coated abrasive material which is spirally wound onto a cloth backing. They are mounted onto the appropriate mandrel and used on hand-held machines (straight grinders or with flexible shafts).

Examples of application:

- preparation work
- light deburring
- polishing
- surface and profile grinding
- fettling

STZY, Mandrels for cylindrical shape

Our mandrels serve exclusively as the means of mounting the cylindrical abrasive bands. Due to the special slots in the mandrel, the abrasive band is firmly secured to the mandrel by the increasing spindle speed.

SBKE, Abrasive Bands, conical

Conical shaped abrasive bands are in principle identical to the cylindrical type with regards to the construction and application. The large taper allows the grinding of difficult-to-access areas of the workpiece.

STKE, Mandrels for conical shape

Our mandrels serve exclusively as the means of mounting the conical abrasive bands. Due to the special slots in the mandrel, the abrasive band is firmly secured to the mandrel by the increasing spindle speed.

SBZY, Abrasive Bands, cylindrical unlined

These particularly flexible abrasive bands are manufactured from abrasive cloth. They are used on hand-held machines (straight grinders or with flexible shaft) and are mounted onto the appropriate mandrel.

STWS, Mounting device for grinding rolls

These mandrels are produced in a specially soft quality; the 19 mm bore with the four keyways mounted with the abrasive band are used on surface conditioning machines.

SBZY, Abrasive Bands, cylindrical shape, Ceramic



★★★

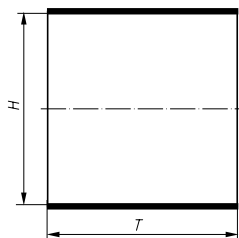

Ordering example: A240603030040

Ceramic = Abrasive cloth ceramic grain



n_{max} : please refer to band mandrels on page 285

Further dimensions and grit sizes on request.



PG 14

Product number	Description	Grit	H mm	T mm	recommended for Information on page 438		
A240603030040	SBZY 03030	Ceramic 40	30	30	1 2 3 4 5 7	■	50
A240603030060	SBZY 03030	Ceramic 60	30	30	1 2 3 4 5 7	■	50
A240604530040	SBZY 04530	Ceramic 40	45	30	1 2 3 4 5 7	■	50
A240604530060	SBZY 04530	Ceramic 60	45	30	1 2 3 4 5 7	■	50
A240604530080	SBZY 04530	Ceramic 80	45	30	1 2 3 4 5 7	■	50
A240606030040	SBZY 06030	Ceramic 40	60	30	1 2 3 4 5 7	■	25
A240606030060	SBZY 06030	Ceramic 60	60	30	1 2 3 4 5 7	■	25

Grinding, Polishing (flexible)

SBZY, Abrasive Bands, cylindrical shape, Z Power



★★★

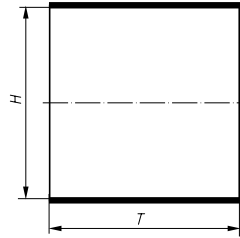

Ordering example: A241203030036

Z Power = zirconia alum. oxide
POWER

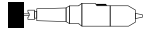

n_{max}: please refer to band mandrels on page 285

Further dimensions and grit sizes on request.



PG 14

Product number	Description	Grit	H mm	T mm	recommended for							■	Information on page 438	📦
					2	3	4	5	7					
A241203030036	SBZY 03030	Z Power 36	30	30	2	3	4	5	7				■	50
A241203030050	SBZY 03030	Z Power 50	30	30	2	3	4	5	7				■	50
A241203030060	SBZY 03030	Z Power 60	30	30	2	3	4	5	7				■	50
A241203030080	SBZY 03030	Z Power 80	30	30	2	3	4	5	7				■	50
A241204530036	SBZY 04530	Z Power 36	45	30	2	3	4	5	7				■	50
A241204530050	SBZY 04530	Z Power 50	45	30	2	3	4	5	7				■	50
A241204530060	SBZY 04530	Z Power 60	45	30	2	3	4	5	7				■	50
A241204530080	SBZY 04530	Z Power 80	45	30	2	3	4	5	7				■	50
A241206030036	SBZY 06030	Z Power 36	60	30	2	3	4	5	7				■	25
A241206030050	SBZY 06030	Z Power 50	60	30	2	3	4	5	7				■	25
A241206030060	SBZY 06030	Z Power 60	60	30	2	3	4	5	7				■	25
A241206030080	SBZY 06030	Z Power 80	60	30	2	3	4	5	7				■	25

Grinding, Polishing
(flexible)

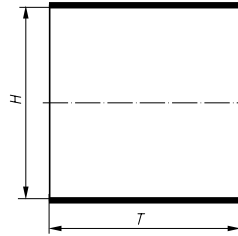
SBZY, Abrasive Bands, cylindrical shape, Zirconia Aluminium Oxide

Ordering example: A240201325050

K = Abrasive cloth with Zirconia Alum. Oxide

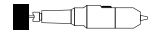
 n_{max}: please refer to band mandrels on page 285

Further dimensions and grit sizes on request..



PG 14

Product number	Description	Grit	H mm	T mm	recommended for Information on page 438								
A240201325050	SBZY 01325	ZK 50	13	25	1	2	3	4	5	7		■	50
A240201325080	SBZY 01325	ZK 80	13	25	1	2	3	4	5	7		■	50
A240201530050	SBZY 01530	ZK 50	15	30	1	2	3	4	5	7		■	50
A240201530060	SBZY 01530	ZK 60	15	30	1	2	3	4	5	7		■	50
A240201530080	SBZY 01530	ZK 80	15	30	1	2	3	4	5	7		■	50
A240201925036	SBZY 01925	ZK 36	19	25	1	2	3	4	5	7		■	50
A240201925050	SBZY 01925	ZK 50	19	25	1	2	3	4	5	7		■	50
A240201925080	SBZY 01925	ZK 80	19	25	1	2	3	4	5	7		■	50
A240202220036	SBZY 02220	ZK 36	22	20	1	2	3	4	5	7		■	50
A240202220050	SBZY 02220	ZK 50	22	20	1	2	3	4	5	7		■	50
A240202220060	SBZY 02220	ZK 60	22	20	1	2	3	4	5	7		■	50
A240202525036	SBZY 02525	ZK 36	25	25	1	2	3	4	5	7		■	50
A240202525050	SBZY 02525	ZK 50	25	25	1	2	3	4	5	7		■	50
A240202525080	SBZY 02525	ZK 80	25	25	1	2	3	4	5	7		■	50
A240203030036	SBZY 03030	ZK 36	30	30	1	2	3	4	5	7		■	50
A240203030050	SBZY 03030	ZK 50	30	30	1	2	3	4	5	7		■	50
A240203030060	SBZY 03030	ZK 60	30	30	1	2	3	4	5	7		■	50
A240203030080	SBZY 03030	ZK 80	30	30	1	2	3	4	5	7		■	50
A240203825036	SBZY 03825	ZK 36	38	25	1	2	3	4	5	7		■	50
A240203825050	SBZY 03825	ZK 50	38	25	1	2	3	4	5	7		■	50
A240203825080	SBZY 03825	ZK 80	38	25	1	2	3	4	5	7		■	50
A240204530036	SBZY 04530	ZK 36	45	30	1	2	3	4	5	7		■	50
A240204530050	SBZY 04530	ZK 50	45	30	1	2	3	4	5	7		■	50
A240204530060	SBZY 04530	ZK 60	45	30	1	2	3	4	5	7		■	50
A240204530080	SBZY 04530	ZK 80	45	30	1	2	3	4	5	7		■	50
A240205125036	SBZY 05125	ZK 36	51	25	1	2	3	4	5	7		■	50
A240205125050	SBZY 05125	ZK 50	51	25	1	2	3	4	5	7		■	50
A240205125080	SBZY 05125	ZK 80	51	25	1	2	3	4	5	7		■	50
A240206030036	SBZY 06030	ZK 36	60	30	1	2	3	4	5	7		■	50
A240206030050	SBZY 06030	ZK 50	60	30	1	2	3	4	5	7		■	50
A240206030060	SBZY 06030	ZK 60	60	30	1	2	3	4	5	7		■	50
A240206030080	SBZY 06030	ZK 80	60	30	1	2	3	4	5	7		■	50

 Grinding, Polishing
(flexible)

SBZY, Abrasive Bands, cylindrical shape, reg. Aluminium Oxide

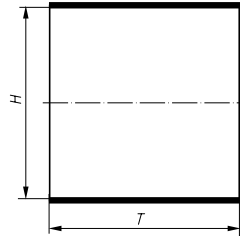
★★☆



Ordering example: A240000810150

NK = reg. Aluminium Oxide

n_{max}: please refer to band mandrels on page 285

Further dimensions and grit sizes on request.

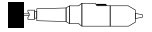

PG 14

Grinding, Polishing
(flexible)

Product number	Description	Grit	H mm	T mm	recommended for Information on page 438		
A240000810150	SBZY 00810	NK 150	8	10	① ② ③ ④ ⑤ ⑥ ⑦ ⑧	■	50
A240001010080	SBZY 01010	NK 80	10	10	① ② ③ ④ ⑤ ⑥ ⑦ ⑧	■	50
A240001010150	SBZY 01010	NK 150	10	10	① ② ③ ④ ⑤ ⑥ ⑦ ⑧	■	50
A240001010240	SBZY 01010	NK 240	10	10	① ② ③ ④ ⑤ ⑥ ⑦ ⑧	■	50
A240001010320	SBZY 01010	NK 320	10	10	① ② ③ ④ ⑤ ⑥ ⑦ ⑧	■	50
A240001020080	SBZY 01020	NK 80	10	20	① ② ③ ④ ⑤ ⑥ ⑦ ⑧	■	50
A240001020150	SBZY 01020	NK 150	10	20	① ② ③ ④ ⑤ ⑥ ⑦ ⑧	■	50
A240001020240	SBZY 01020	NK 240	10	20	① ② ③ ④ ⑤ ⑥ ⑦ ⑧	■	50
A240001020320	SBZY 01020	NK 320	10	20	① ② ③ ④ ⑤ ⑥ ⑦ ⑧	■	50
A240001210080	SBZY 01210	NK 80	12	10	① ② ③ ④ ⑤ ⑥ ⑦ ⑧	■	50
A240001210150	SBZY 01210	NK 150	12	10	① ② ③ ④ ⑤ ⑥ ⑦ ⑧	■	50
A240001210240	SBZY 01210	NK 240	12	10	① ② ③ ④ ⑤ ⑥ ⑦ ⑧	■	50
A240001213080	SBZY 01213	NK 80	12	13	① ② ③ ④ ⑤ ⑥ ⑦ ⑧	■	50
A240001213120	SBZY 01213	NK 120	12	13	① ② ③ ④ ⑤ ⑥ ⑦ ⑧	■	50
A240001213240	SBZY 01213	NK 240	12	13	① ② ③ ④ ⑤ ⑥ ⑦ ⑧	■	50
A240001225080	SBZY 01225	NK 80	12	25	① ② ③ ④ ⑤ ⑥ ⑦ ⑧	■	50
A240001225150	SBZY 01225	NK 150	12	25	① ② ③ ④ ⑤ ⑥ ⑦ ⑧	■	50
A240001225240	SBZY 01225	NK 240	12	25	① ② ③ ④ ⑤ ⑥ ⑦ ⑧	■	50
A240001225320	SBZY 01225	NK 320	12	25	① ② ③ ④ ⑤ ⑥ ⑦ ⑧	■	50
A240001250080	SBZY 01250	NK 80	12	50	① ② ③ ④ ⑤ ⑥ ⑦ ⑧	■	50
A240001310080	SBZY 01310	NK 80	13	10	① ② ③ ④ ⑤ ⑥ ⑦ ⑧	■	50
A240001310150	SBZY 01310	NK 150	13	10	① ② ③ ④ ⑤ ⑥ ⑦ ⑧	■	50
A240001325080	SBZY 01325	NK 80	13	25	① ② ③ ④ ⑤ ⑥ ⑦ ⑧	■	50
A240001325150	SBZY 01325	NK 150	13	25	① ② ③ ④ ⑤ ⑥ ⑦ ⑧	■	50
A240001510060	SBZY 01510	NK 60	15	10	① ② ③ ④ ⑤ ⑥ ⑦ ⑧	■	50
A240001510080	SBZY 01510	NK 80	15	10	① ② ③ ④ ⑤ ⑥ ⑦ ⑧	■	50
A240001510150	SBZY 01510	NK 150	15	10	① ② ③ ④ ⑤ ⑥ ⑦ ⑧	■	50
A240001510240	SBZY 01510	NK 240	15	10	① ② ③ ④ ⑤ ⑥ ⑦ ⑧	■	50
A240001510320	SBZY 01510	NK 320	15	10	① ② ③ ④ ⑤ ⑥ ⑦ ⑧	■	50
A240001530040	SBZY 01530	NK 40	15	30	① ② ③ ④ ⑤ ⑥ ⑦ ⑧	■	50
A240001530050	SBZY 01530	NK 50	15	30	① ② ③ ④ ⑤ ⑥ ⑦ ⑧	■	50
A240001530060	SBZY 01530	NK 60	15	30	① ② ③ ④ ⑤ ⑥ ⑦ ⑧	■	50
A240001530080	SBZY 01530	NK 80	15	30	① ② ③ ④ ⑤ ⑥ ⑦ ⑧	■	50
A240001530120	SBZY 01530	NK 120	15	30	① ② ③ ④ ⑤ ⑥ ⑦ ⑧	■	50
A240001530150	SBZY 01530	NK 150	15	30	① ② ③ ④ ⑤ ⑥ ⑦ ⑧	■	50
A240001530240	SBZY 01530	NK 240	15	30	① ② ③ ④ ⑤ ⑥ ⑦ ⑧	■	50
A240001530320	SBZY 01530	NK 320	15	30	① ② ③ ④ ⑤ ⑥ ⑦ ⑧	■	50

SBZY, Abrasive Bands, cylindrical shape, reg. Aluminium Oxide

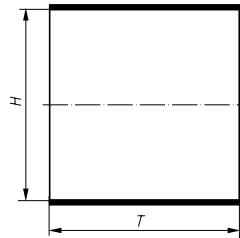

Ordering example: A240000810150

NK = reg. Aluminium Oxide

n_{max.}: please refer to band mandrels on page 285

Further dimensions and grit sizes on request.

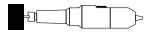

PG 14

Product number	Description	Grit	H mm	T mm	recommended for Information on page 438		
A240001550050	SBZY 01550	NK 50	15	50	① ② ③ ④ ⑤ ⑥ ⑦ ⑧	■	50
A240001925050	SBZY 01925	NK 50	19	25	① ② ③ ④ ⑤ ⑥ ⑦ ⑧	■	50
A240001925060	SBZY 01925	NK 60	19	25	① ② ③ ④ ⑤ ⑥ ⑦ ⑧	■	50
A240001925080	SBZY 01925	NK 80	19	25	① ② ③ ④ ⑤ ⑥ ⑦ ⑧	■	50
A240001925150	SBZY 01925	NK 150	19	25	① ② ③ ④ ⑤ ⑥ ⑦ ⑧	■	50
A240002210150	SBZY 02210	NK 150	22	10	① ② ③ ④ ⑤ ⑥ ⑦ ⑧	■	50
A240002210240	SBZY 02210	NK 240	22	10	① ② ③ ④ ⑤ ⑥ ⑦ ⑧	■	50
A240002210320	SBZY 02210	NK 320	22	10	① ② ③ ④ ⑤ ⑥ ⑦ ⑧	■	50
A240002220050	SBZY 02220	NK 50	22	20	① ② ③ ④ ⑤ ⑥ ⑦ ⑧	■	50
A240002220060	SBZY 02220	NK 60	22	20	① ② ③ ④ ⑤ ⑥ ⑦ ⑧	■	50
A240002220080	SBZY 02220	NK 80	22	20	① ② ③ ④ ⑤ ⑥ ⑦ ⑧	■	50
A240002220150	SBZY 02220	NK 150	22	20	① ② ③ ④ ⑤ ⑥ ⑦ ⑧	■	50
A240002220240	SBZY 02220	NK 240	22	20	① ② ③ ④ ⑤ ⑥ ⑦ ⑧	■	50
A240002220320	SBZY 02220	NK 320	22	20	① ② ③ ④ ⑤ ⑥ ⑦ ⑧	■	50
A240002250050	SBZY 02250	NK 50	22	50	① ② ③ ④ ⑤ ⑥ ⑦ ⑧	■	50
A240002525040	SBZY 02525	NK 40	25	25	① ② ③ ④ ⑤ ⑥ ⑦ ⑧	■	50
A240002525050	SBZY 02525	NK 50	25	25	① ② ③ ④ ⑤ ⑥ ⑦ ⑧	■	50
A240002525060	SBZY 02525	NK 60	25	25	① ② ③ ④ ⑤ ⑥ ⑦ ⑧	■	50
A240002525080	SBZY 02525	NK 80	25	25	① ② ③ ④ ⑤ ⑥ ⑦ ⑧	■	50
A240002525150	SBZY 02525	NK 150	25	25	① ② ③ ④ ⑤ ⑥ ⑦ ⑧	■	50
A240003020040	SBZY 03020	NK 40	30	20	① ② ③ ④ ⑤ ⑥ ⑦ ⑧	■	50
A240003020050	SBZY 03020	NK 50	30	20	① ② ③ ④ ⑤ ⑥ ⑦ ⑧	■	50
A240003020060	SBZY 03020	NK 60	30	20	① ② ③ ④ ⑤ ⑥ ⑦ ⑧	■	50
A240003020080	SBZY 03020	NK 80	30	20	① ② ③ ④ ⑤ ⑥ ⑦ ⑧	■	50
A240003020150	SBZY 03020	NK 150	30	20	① ② ③ ④ ⑤ ⑥ ⑦ ⑧	■	50
A240003020240	SBZY 03020	NK 240	30	20	① ② ③ ④ ⑤ ⑥ ⑦ ⑧	■	50
A240003030040	SBZY 03030	NK 40	30	30	① ② ③ ④ ⑤ ⑥ ⑦ ⑧	■	50
A240003030050	SBZY 03030	NK 50	30	30	① ② ③ ④ ⑤ ⑥ ⑦ ⑧	■	50
A240003030060	SBZY 03030	NK 60	30	30	① ② ③ ④ ⑤ ⑥ ⑦ ⑧	■	50
A240003030080	SBZY 03030	NK 80	30	30	① ② ③ ④ ⑤ ⑥ ⑦ ⑧	■	50
A240003030150	SBZY 03030	NK 150	30	30	① ② ③ ④ ⑤ ⑥ ⑦ ⑧	■	50
A240003030240	SBZY 03030	NK 240	30	30	① ② ③ ④ ⑤ ⑥ ⑦ ⑧	■	50
A240003030320	SBZY 03030	NK 320	30	30	① ② ③ ④ ⑤ ⑥ ⑦ ⑧	■	50
A240003825040	SBZY 03825	NK 40	38	25	① ② ③ ④ ⑤ ⑥ ⑦ ⑧	■	50
A240003825050	SBZY 03825	NK 50	38	25	① ② ③ ④ ⑤ ⑥ ⑦ ⑧	■	50
A240003825060	SBZY 03825	NK 60	38	25	① ② ③ ④ ⑤ ⑥ ⑦ ⑧	■	50
A240003825080	SBZY 03825	NK 80	38	25	① ② ③ ④ ⑤ ⑥ ⑦ ⑧	■	50

Grinding, Polishing
(flexible)

SBZY, Abrasive Bands, cylindrical shape, reg. Aluminium Oxide

★★☆

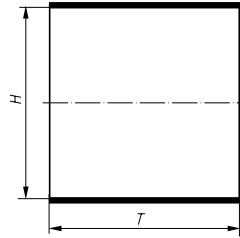

Ordering example: A240000810150

NK = reg. Aluminium Oxide

n_{max}: please refer to band mandrels on page 285

Further dimensions and grit sizes on request.

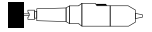

PG 14

Grinding, Polishing
(flexible)

Product number	Description	Grit	H mm	T mm	recommended for Information on page 438		
A240003825150	SBZY 03825	NK 150	38	25	① ② ③ ④ ⑤ ⑥ ⑦ ⑧	■	50
A240004530040	SBZY 04530	NK 40	45	30	① ② ③ ④ ⑤ ⑥ ⑦ ⑧	■	50
A240004530050	SBZY 04530	NK 50	45	30	① ② ③ ④ ⑤ ⑥ ⑦ ⑧	■	50
A240004530060	SBZY 04530	NK 60	45	30	① ② ③ ④ ⑤ ⑥ ⑦ ⑧	■	50
A240004530080	SBZY 04530	NK 80	45	30	① ② ③ ④ ⑤ ⑥ ⑦ ⑧	■	50
A240004530150	SBZY 04530	NK 150	45	30	① ② ③ ④ ⑤ ⑥ ⑦ ⑧	■	50
A240004530240	SBZY 04530	NK 240	45	30	① ② ③ ④ ⑤ ⑥ ⑦ ⑧	■	50
A240004530320	SBZY 04530	NK 320	45	30	① ② ③ ④ ⑤ ⑥ ⑦ ⑧	■	50
A240005125040	SBZY 05125	NK 40	51	25	① ② ③ ④ ⑤ ⑥ ⑦ ⑧	■	50
A240005125050	SBZY 05125	NK 50	51	25	① ② ③ ④ ⑤ ⑥ ⑦ ⑧	■	50
A240005125060	SBZY 05125	NK 60	51	25	① ② ③ ④ ⑤ ⑥ ⑦ ⑧	■	50
A240005125080	SBZY 05125	NK 80	51	25	① ② ③ ④ ⑤ ⑥ ⑦ ⑧	■	50
A240005125150	SBZY 05125	NK 150	51	25	① ② ③ ④ ⑤ ⑥ ⑦ ⑧	■	50
A240006030040	SBZY 06030	NK 40	60	30	① ② ③ ④ ⑤ ⑥ ⑦ ⑧	■	50
A240006030050	SBZY 06030	NK 50	60	30	① ② ③ ④ ⑤ ⑥ ⑦ ⑧	■	50
A240006030060	SBZY 06030	NK 60	60	30	① ② ③ ④ ⑤ ⑥ ⑦ ⑧	■	50
A240006030080	SBZY 06030	NK 80	60	30	① ② ③ ④ ⑤ ⑥ ⑦ ⑧	■	50
A240006030150	SBZY 06030	NK 150	60	30	① ② ③ ④ ⑤ ⑥ ⑦ ⑧	■	50
A240007530040	SBZY 07530	NK 40	75	30	① ② ③ ④ ⑤ ⑥ ⑦ ⑧	■	50
A240007530050	SBZY 07530	NK 50	75	30	① ② ③ ④ ⑤ ⑥ ⑦ ⑧	■	50
A240007530060	SBZY 07530	NK 60	75	30	① ② ③ ④ ⑤ ⑥ ⑦ ⑧	■	50
A240007530080	SBZY 07530	NK 80	75	30	① ② ③ ④ ⑤ ⑥ ⑦ ⑧	■	50
A240007530150	SBZY 07530	NK 150	75	30	① ② ③ ④ ⑤ ⑥ ⑦ ⑧	■	50
A240010040040	SBZY 10040	NK 40	100	40	① ② ③ ④ ⑤ ⑥ ⑦ ⑧	■	25
A240010040050	SBZY 10040	NK 50	100	40	① ② ③ ④ ⑤ ⑥ ⑦ ⑧	■	25
A240010040060	SBZY 10040	NK 60	100	40	① ② ③ ④ ⑤ ⑥ ⑦ ⑧	■	25
A240010040080	SBZY 10040	NK 80	100	40	① ② ③ ④ ⑤ ⑥ ⑦ ⑧	■	25
A240010040150	SBZY 10040	NK 150	100	40	① ② ③ ④ ⑤ ⑥ ⑦ ⑧	■	25

STZY, Mandrels cylindrical shape



Ordering example: A2500010103

Further dimensions on request.

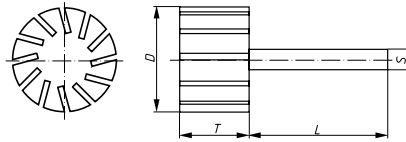
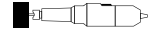

PG 14

Product number	Description	Type	D mm	T mm	S mm	L mm	n max (1/min)	recommended for Information on page 438		
A2501008103	STZY 00810.03	soft	8	10	3	40	47.500		■	5
A2500010103	STZY 01010.03	hard	10	10	3	25	54.000		■	5
A2500010106	STZY 01010.06	hard	10	10	6	40	57.000		■	5
A2500010206	STZY 01020.06	hard	10	20	6	40	57.000		■	5
A2500012106	STZY 01210.06	hard	12	10	6	40	46.500		■	5
A2500012132	STZY 01213.02	hard	12	13	2,35	40	26.000		■	5
A2500012256	STZY 01225.06	hard	12	25	6	40	46.500		■	5
A2501012256	STZY 01225.06	soft	12	25	6	40	31.500		■	5
A2500012506	STZY 01250.06	hard	12	50	6	40	31.500		■	5
A2500013106	STZY 01310.06	hard	13	10	6	40	44.000		■	5
A2500013256	STZY 01325.06	hard	13	25	6	40	44.000		■	5
A2500015106	STZY 01510.06	hard	15	10	6	40	38.000		■	5
A2500015306	STZY 01530.06	hard	15	30	6	40	38.000		■	5
A2501015306	STZY 01530.06	soft	15	30	6	40	25.000		■	5
A2500015506	STZY 01550.06	hard	15	50	6	40	25.000		■	5
A2500019256	STZY 01925.06	hard	19	25	6	40	30.000		■	5
A2500022106	STZY 02210.06	hard	22	10	6	40	26.000		■	5
A2500022206	STZY 02220.06	hard	22	20	6	40	26.000		■	5
A2501022206	STZY 02220.06	soft	22	20	6	40	17.000		■	5
A2500022506	STZY 02250.06	hard	22	50	6	40	17.000		■	5
A2500025256	STZY 02525.06	hard	25	25	6	40	22.500		■	5
A2500030206	STZY 03020.06	hard	30	20	6	40	19.000		■	5
A2501030206	STZY 03020.06	soft	30	20	6	40	12.500		■	5
A2500030306	STZY 03030.06	hard	30	30	6	40	19.000		■	5
A2501030306	STZY 03030.06	soft	30	30	6	40	12.500		■	5
A2500038256	STZY 03825.06	hard	38	25	6	40	15.000		■	5
A25000453060001	STZY 04530.06	hard	45	30	6	40	13.000		■	5
A25010453060001	STZY 04530.06	soft	45	30	6	40	13.000		■	5
A2500051256	STZY 05125.06	hard	51	25	6	40	11.200		■	5
A25000603060001	STZY 06030.06	hard	60	30	6	40	9.500		■	5
A25010603060001	STZY 06030.06	soft	60	30	6	40	6.500		■	5
A2500060308	STZY 06030.08	hard	60	30	8	40	9.500		■	5
A25000753080001	STZY 07530.08	hard	75	30	8	40	6.500		■	2
A25011004080001	STZY 10040.08	soft	100	40	8	40	4.000		■	2

Grinding, Polishing (flexible)

The stated maximum operating speed only applies to a maximum overhang L_0 of 20 mm. Other overhang dimensions must be calculated separately.

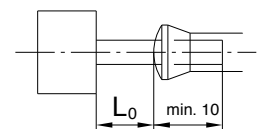

SBZY, Abrasive Bands, cylindrical, unlined

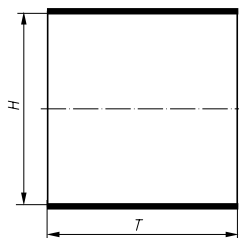

Ordering example: A300003030080

n_{max} : please refer to band mandrels on page 285 and 286

NK = reg. Aluminium Oxide



PG 14

Product number	Description	Grit	H mm	T mm	recommended for Information on page 438		
A300003030080	SBZY 03030	NK 80	30	30	① ② ③ ④ ⑤ ⑥ ⑦ ⑧	■	50
A300003030120	SBZY 03030	NK 120	30	30	① ② ③ ④ ⑤ ⑥ ⑦ ⑧	■	50
A300003030150	SBZY 03030	NK 150	30	30	① ② ③ ④ ⑤ ⑥ ⑦ ⑧	■	50
A300004530080	SBZY 04530	NK 80	45	30	① ② ③ ④ ⑤ ⑥ ⑦ ⑧	■	50
A300004530120	SBZY 04530	NK 120	45	30	① ② ③ ④ ⑤ ⑥ ⑦ ⑧	■	50
A300004530150	SBZY 04530	NK 150	45	30	① ② ③ ④ ⑤ ⑥ ⑦ ⑧	■	50

Characteristics:

- Particularly flexible

Grinding, Polishing
(flexible)

STZY, Mandrels for cylindrical shape, soft

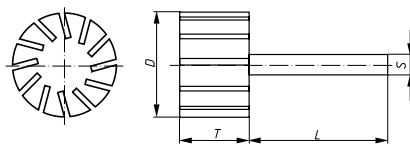

Ordering example: A2502030306

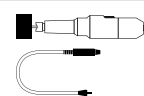

PG 14

Product number	Description	Type	D mm	T mm	S mm	L mm	n max. (1/min)	recommended for Information on page 438		
A2502030306	STZY 03030.06	soft	30	30	6	40	9.500		■	5
A2502045306	STZY 04530.06	soft	45	30	6	40	6.300		■	5
A2502060306	STZY 06030.06	soft	60	30	6	40	4.700		■	5
A2502075308	STZY 07530.08	soft	75	30	8	40	3.800		■	2
A2502100408	STZY 10040.08	soft	100	40	8	40	2.800		■	2

The stated maximum operating speed only applies to a maximum overhang L_0 of 20 mm. Other overhang dimensions must be calculated separately.

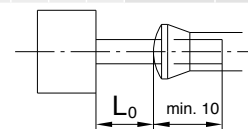

SBKE, Abrasive Bands, conical shape

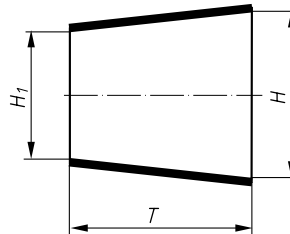

Ordering example: A300002063040

n max.: please refer to band mandrels on page 287

NK = reg. Aluminium Oxide

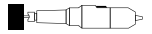

PG 14

Product number	Description	Grit	H mm	T mm	H ₁ mm	recommended for Information on page 438		
A300002063040	SBKE 02063	NK 40	20	63	14	① ② ③ ④ ⑤ ⑥ ⑦ ⑧	■	50
A300002063060	SBKE 02063	NK 60	20	63	14	① ② ③ ④ ⑤ ⑥ ⑦ ⑧	■	50
A300002063080	SBKE 02063	NK 80	20	63	14	① ② ③ ④ ⑤ ⑥ ⑦ ⑧	■	50
A300002063150	SBKE 02063	NK 150	20	63	14	① ② ③ ④ ⑤ ⑥ ⑦ ⑧	■	50
A300002930040	SBKE 02930	NK 40	29	30	22	① ② ③ ④ ⑤ ⑥ ⑦ ⑧	■	50
A300002930050	SBKE 02930	NK 50	29	30	22	① ② ③ ④ ⑤ ⑥ ⑦ ⑧	■	50
A300002930060	SBKE 02930	NK 60	29	30	22	① ② ③ ④ ⑤ ⑥ ⑦ ⑧	■	50
A300002930080	SBKE 02930	NK 80	29	30	22	① ② ③ ④ ⑤ ⑥ ⑦ ⑧	■	50
A300002930150	SBKE 02930	NK 150	29	30	22	① ② ③ ④ ⑤ ⑥ ⑦ ⑧	■	50
A300003660040	SBKE 03660	NK 40	36	60	22	① ② ③ ④ ⑤ ⑥ ⑦ ⑧	■	50
A300003660050	SBKE 03660	NK 50	36	60	22	① ② ③ ④ ⑤ ⑥ ⑦ ⑧	■	50
A300003660060	SBKE 03660	NK 60	36	60	22	① ② ③ ④ ⑤ ⑥ ⑦ ⑧	■	50
A300003660080	SBKE 03660	NK 80	36	60	22	① ② ③ ④ ⑤ ⑥ ⑦ ⑧	■	50
A300003660150	SBKE 03660	NK 150	36	60	22	① ② ③ ④ ⑤ ⑥ ⑦ ⑧	■	50

Grinding, Polishing
(flexible)

STKE, Mandrels for conical shape

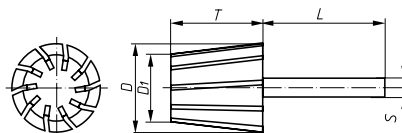

Ordering example: A2500020636



PG 14

Product number	Description	Type	D mm	T mm	S mm	D ₁ mm	L mm	n max. (1/min)	recommended for Information on page 438		
A2500020636	STKE 02063.06	hard	20	63	6	14	40	21.000		■	5
A2500029306	STKE 02930.06	hard	29	30	6	22	40	21.000		■	5
A2500036606	STKE 03660.06	hard	36	60	6	22	40	13.500		■	5

The stated maximum operating speed only applies to a maximum overhang L₀ of 20 mm. Other overhang dimensions must be calculated separately.

SBZY, Grinding rolls

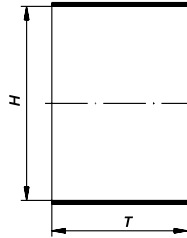

Ordering example: A2400100100060

n_{max} : please refer to band mandrels on page 288

NK = reg. Aluminium Oxide

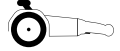

PG 14

Product number	Description	Grit	H mm	T mm	recommended for Information on page 438		
A2400100100060	SBZY 100100	NK 60	100	100	① ② ③ ④ ⑤ ⑥ ⑦ ⑧	■	6
A2400100100080	SBZY 100100	NK 80	100	100	① ② ③ ④ ⑤ ⑥ ⑦ ⑧	■	6
A2400100100120	SBZY 100100	NK 120	100	100	① ② ③ ④ ⑤ ⑥ ⑦ ⑧	■	6
A2400100100150	SBZY 100100	NK 150	100	100	① ② ③ ④ ⑤ ⑥ ⑦ ⑧	■	6

Grinding, Polishing
(flexible)

STWS, Mounting device for grinding rolls

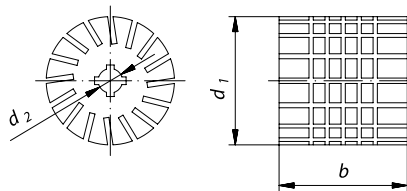

Ordering example: A2502100100

The bore \varnothing 19 mm has a keyway of 6 mm.

Machines to suit: Page 382

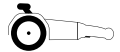

PG 14

Product number	Description	Type	d_1 mm	b mm	Bore d_2 mm	n max. (1/min)	recommended for Information on page 438		
A2502100100	STWS 100100	soft	100	100	19	2.800		■	1

SBL, Linishing belts

★★☆

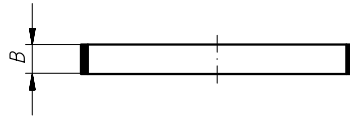

Ordering example: A3000130305040T01

Used on our pneumatic belt grinder
AMIN 30 BSH

Peripheral speed: 28 m/s

NK = reg. Aluminium Oxide

ZK = Zirconia Alum. Oxide

PG 8

Product number	Description	Grit	B mm	Length mm	Lining	recommended for Information on page 438		
A3000130305040T01	SBLT	ZK 40	13	305	robust-flexible	① ② ③ ④ ⑤ ⑧	■	100
A3000130305060T	SBLT	NK 60	13	305	robust-flexible	① ② ③ ④ ⑤ ⑥ ⑦ ⑧	■	100
A3000130305060T01	SBLT	ZK 60	13	305	robust-flexible	① ② ③ ④ ⑤ ⑧	■	100
A3000130305080T	SBLT	NK 80	13	305	robust-flexible	① ② ③ ④ ⑤ ⑥ ⑦ ⑧	■	100
A3000130305080T01	SBLT	ZK 80	13	305	robust-flexible	① ② ③ ④ ⑤ ⑧	■	100
A3000130305080X	SBLX	NK 80	13	305	robust	① ② ③ ④ ⑤ ⑥ ⑦ ⑧	■	100
A3000130305120T	SBLT	NK 120	13	305	robust-flexible	① ② ③ ④ ⑤ ⑥ ⑦ ⑧	■	100

Grinding, Polishing
(flexible)

Abrasive belt grinder – insulated

★★☆



Ordering example: A3993302113

Length: approx. 325 mm

Height: approx. 86 mm

Weight: approx. 0,90 kg

Drive: vane motor

For more technical specifications see page 370.

PG 15

Product number	Description	Valve	Idle speed min ⁻¹	Power consumption	Air consumption on a load m ³ /min.	Belt peripheral speed m/s	Hose-nominal size mm		
A3993302113	AMIN 30 BSH	Lever	30.000	0,3	0,45	28	6	■	1

Included with the machine: an abrasive belt mounting arm for long belts in dimension 13 x 305 mm, inlet and exhaust air hoses plus silencer, collet for 6 mm, spanner

Extra equipment: collets for Ø 3 mm, 4 mm, 5 mm, 1/8", 3/16", 1/4"

Abrasive belt extensions in various sizes (lengths, widths and roll diameters) available ex stock

Available ex-stock: long belts 13 x 305 mm

Abrasive Rolls and Mandrels

196 Qualities and Applications

292 General Information

293 Abrasive rolls, cylindrical

295 Abrasive rolls, conical

295 Mandrels

369 Power tools

Product line marking

The product lines are illustrated by star symbols at the top of the table; please refer to page **14** and **15**.

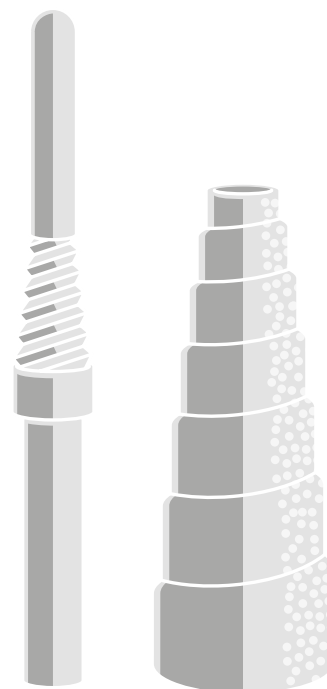

Grinding, Polishing
(flexible)

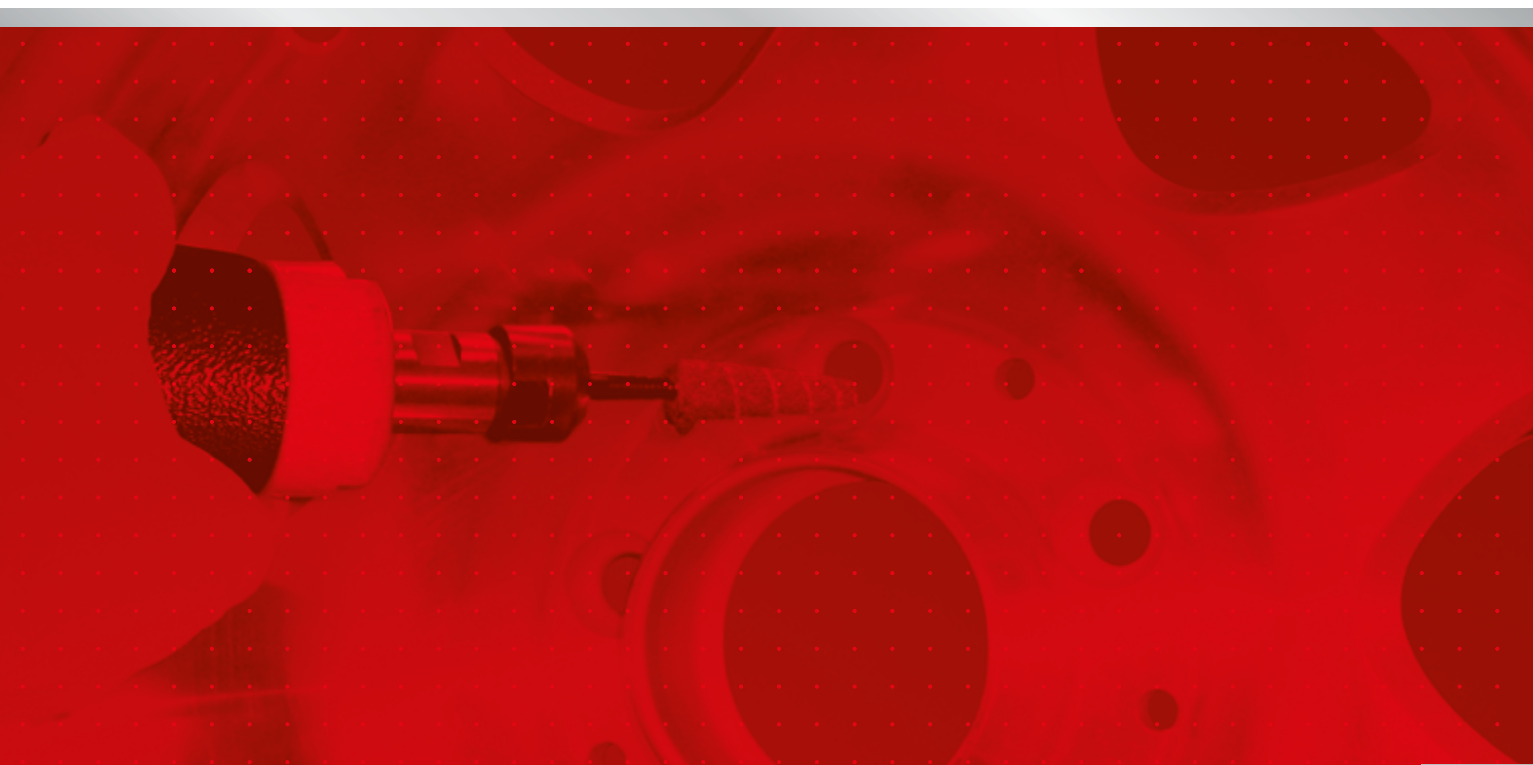

Information

SRZY, Abrasive rolls, cylindrical and SRKE Abrasive rolls, conical

These abrasive rolls consist of wound coated abrasive material. Their construction guarantees a free-cutting tool; the outer coating wears during the grinding process which then allows new grain particle to be exposed. Their construction guarantees a free-cutting tool; the outer coating wears during the grinding process which then allows new grain particle to be exposed.

Examples of application

- deburring
- preparation work
- fettling

SRTR, Mandrels

Reusable mandrels for the safe mounting of cylindrical and conical abrasive rolls.

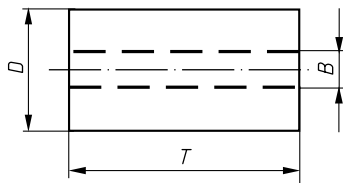
SRZY, Abrasive rolls, cylindrical

Ordering example: A2403006380600001

Ceramic = ceramic grain

PG 8

Product number	Description	Grit	D mm	T mm	B mm	n max. (1/min)	Suitable mandrels	recommended for							Information on page 438	50
								1	2	3	4	5	7			
A2403006380600001	SRZY 0638	Ceramic 60	6	38	3	24.000	SRTR 3063.03 or SRTR 3063.06	1	2	3	4	5	7		50	
A2403006380800001	SRZY 0638	Ceramic 80	6	38	3	24.000	SRTR 3063.03 or SRTR 3063.06	1	2	3	4	5	7		50	
A2403006381200001	SRZY 0638	Ceramic 120	6	38	3	24.000	SRTR 3063.03 or SRTR 3063.06	1	2	3	4	5	7		50	
A2403010380600001	SRZY 1038	Ceramic 60	10	38	3	24.000	SRTR 3070.06	1	2	3	4	5	7		50	
A2403010380800001	SRZY 1038	Ceramic 80	10	38	3	24.000	SRTR 3070.06	1	2	3	4	5	7		50	
A2403010381200001	SRZY 1038	Ceramic 120	10	38	3	24.000	SRTR 3070.06	1	2	3	4	5	7		50	
A2403013380600001	SRZY 1338	Ceramic 60	13	38	3	24.000	SRTR 3070.06	1	2	3	4	5	7		50	
A2403013380800001	SRZY 1338	Ceramic 80	13	38	3	24.000	SRTR 3070.06	1	2	3	4	5	7		50	
A2403013381200001	SRZY 1338	Ceramic 120	13	38	3	24.000	SRTR 3070.06	1	2	3	4	5	7		50	

Grinding, Polishing (flexible)

SRZY, Abrasive rolls, cylindrical

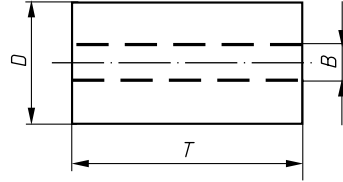

Ordering example: A240300625080

NK = reg. Aluminium Oxide



PG 8

Grinding, Polishing
(flexible)

Product number	Description	Grit	D mm	T mm	B mm	n max. (1/min)	Suitable mandrels	recommended for Information on page 438		
A240300625080	SRZY 0625	NK 80	6	25	3	24.000	SRTR 3063.03 or SRTR 3063.06	① ② ③ ④ ⑤ ⑥ ⑦ ⑧	■	50
A240300625150	SRZY 0625	NK 150	6	25	3	24.000	SRTR 3063.03 or SRTR 3063.06	① ② ③ ④ ⑤ ⑥ ⑦ ⑧	■	50
A240300638080	SRZY 0638	NK 80	6	38	3	24.000	SRTR 3063.03 or SRTR 3063.06	① ② ③ ④ ⑤ ⑥ ⑦ ⑧	■	50
A240300638150	SRZY 0638	NK 150	6	38	3	24.000	SRTR 3063.03 or SRTR 3063.06	① ② ③ ④ ⑤ ⑥ ⑦ ⑧	■	50
A240301025050	SRZY 1025	NK 50	10	25	3	24.000	SRTR 3063.03 or SRTR 3063.06	① ② ③ ④ ⑤ ⑥ ⑦ ⑧	■	50
A240301025080	SRZY 1025	NK 80	10	25	3	24.000	SRTR 3063.03 or SRTR 3063.06	① ② ③ ④ ⑤ ⑥ ⑦ ⑧	■	50
A240301025150	SRZY 1025	NK 150	10	25	3	24.000	SRTR 3063.03 or SRTR 3063.06	① ② ③ ④ ⑤ ⑥ ⑦ ⑧	■	50
A240301038050	SRZY 1038	NK 50	10	38	3	24.000	SRTR 3070.06	① ② ③ ④ ⑤ ⑥ ⑦ ⑧	■	50
A240301038080	SRZY 1038	NK 80	10	38	3	24.000	SRTR 3070.06	① ② ③ ④ ⑤ ⑥ ⑦ ⑧	■	50
A240301038150	SRZY 1038	NK 150	10	38	3	24.000	SRTR 3070.06	① ② ③ ④ ⑤ ⑥ ⑦ ⑧	■	50
A240301325050	SRZY 1325	NK 50	13	25	3	24.000	SRTR 3063.06	① ② ③ ④ ⑤ ⑥ ⑦ ⑧	■	50
A240301325080	SRZY 1325	NK 80	13	25	3	24.000	SRTR 3063.06	① ② ③ ④ ⑤ ⑥ ⑦ ⑧	■	50
A240301325150	SRZY 1325	NK 150	13	25	3	24.000	SRTR 3063.06	① ② ③ ④ ⑤ ⑥ ⑦ ⑧	■	50
A240301338050	SRZY 1338	NK 50	13	38	3	24.000	SRTR 3070.06	① ② ③ ④ ⑤ ⑥ ⑦ ⑧	■	50
A240301338080	SRZY 1338	NK 80	13	38	3	24.000	SRTR 3070.06	① ② ③ ④ ⑤ ⑥ ⑦ ⑧	■	50
A240301338150	SRZY 1338	NK 150	13	38	3	24.000	SRTR 3070.06	① ② ③ ④ ⑤ ⑥ ⑦ ⑧	■	50
A240302038050	SRZY 2038	NK 50	20	38	5	16.000	SRTR 5085.06	① ② ③ ④ ⑤ ⑥ ⑦ ⑧	■	50
A240302038080	SRZY 2038	NK 80	20	38	5	16.000	SRTR 5085.06	① ② ③ ④ ⑤ ⑥ ⑦ ⑧	■	50
A240302038150	SRZY 2038	NK 150	20	38	5	16.000	SRTR 5085.06	① ② ③ ④ ⑤ ⑥ ⑦ ⑧	■	50
A240302050050	SRZY 2050	NK 50	20	50	5	16.000	SRTR 5085.06	① ② ③ ④ ⑤ ⑥ ⑦ ⑧	■	50
A240302050080	SRZY 2050	NK 80	20	50	5	16.000	SRTR 5085.06	① ② ③ ④ ⑤ ⑥ ⑦ ⑧	■	50

SRKE, Abrasive rolls, conical

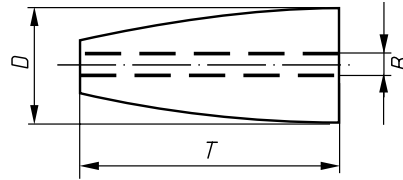

Ordering example: A240401025050

NK = reg. Aluminium Oxide

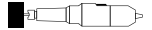

PG 8

Product number	Description	Grit	D mm	T mm	B mm	n max. (1/min)	Suitable mandrels	recommended for	Information on page 438		
A240401025050	SRKE 1025	NK 50	10	25	3	24.000	SRTR 3063.03 or SRTR 3063.06	① ② ③ ④ ⑤ ⑥ ⑦ ⑧		■	50
A240401025080	SRKE 1025	NK 80	10	25	3	24.000	SRTR 3063.03 or SRTR 3063.06	① ② ③ ④ ⑤ ⑥ ⑦ ⑧		■	50
A240401025150	SRKE 1025	NK 150	10	25	3	24.000	SRTR 3063.03 or SRTR 3063.06	① ② ③ ④ ⑤ ⑥ ⑦ ⑧		■	50
A240401325050	SRKE 1325	NK 50	13	25	3	24.000	SRTR 3063.06	① ② ③ ④ ⑤ ⑥ ⑦ ⑧		■	50
A240401325080	SRKE 1325	NK 80	13	25	3	24.000	SRTR 3063.06	① ② ③ ④ ⑤ ⑥ ⑦ ⑧		■	50
A240401325150	SRKE 1325	NK 150	13	25	3	24.000	SRTR 3063.06	① ② ③ ④ ⑤ ⑥ ⑦ ⑧		■	50
A240401338050	SRKE 1338	NK 50	13	38	3	24.000	SRTR 3070.06	① ② ③ ④ ⑤ ⑥ ⑦ ⑧		■	50
A240401338080	SRKE 1338	NK 80	13	38	3	24.000	SRTR 3070.06	① ② ③ ④ ⑤ ⑥ ⑦ ⑧		■	50
A240401338150	SRKE 1338	NK 150	13	38	3	24.000	SRTR 3070.06	① ② ③ ④ ⑤ ⑥ ⑦ ⑧		■	50
A240401638050	SRKE 1638	NK 50	16	38	3	16.000	SRTR 3070.06	① ② ③ ④ ⑤ ⑥ ⑦ ⑧		■	50
A240401638080	SRKE 1638	NK 80	16	38	3	16.000	SRTR 3070.06	① ② ③ ④ ⑤ ⑥ ⑦ ⑧		■	50
A240401638150	SRKE 1638	NK 150	16	38	3	16.000	SRTR 3070.06	① ② ③ ④ ⑤ ⑥ ⑦ ⑧		■	50
A240402050036	SRKE 2050	NK 36	20	50	5	16.000	SRTR 5085.06	① ② ③ ④ ⑤ ⑥ ⑦ ⑧		■	50
A240402050050	SRKE 2050	NK 50	20	50	5	16.000	SRTR 5085.06	① ② ③ ④ ⑤ ⑥ ⑦ ⑧		■	50
A240402050080	SRKE 2050	NK 80	20	50	5	16.000	SRTR 5085.06	① ② ③ ④ ⑤ ⑥ ⑦ ⑧		■	50
A240402050150	SRKE 2050	NK 150	20	50	5	16.000	SRTR 5085.06	① ② ③ ④ ⑤ ⑥ ⑦ ⑧		■	50

Grinding, Polishing (flexible)

SRTR, Mandrels

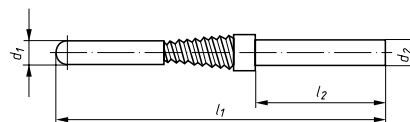

Ordering example: A32030130001

n_{max.}: please refer to abrasive rolls on page 293–295



PG 8

Product number	Description	Type	d ₁ mm	l ₁ mm	d ₂ mm	l ₂ mm	recommended for	Information on page 438		
A32030130001	SRTR 3063.03	Inox	3	64	3	27			■	1
A32030160001	SRTR 3063.06	Inox	3	64	6	27			■	1
A32030260001	SRTR 3070.06	Inox	3	70	6	25			■	1
A32030460001	SRTR 5085.06	Inox	5	85	6	35			■	1

Abrasive Caps and Abrasive Sleeves

196 Qualities and Applications

298 General Information

299 Abrasive caps, cylindrical

300 Mandrel, cylindrical

301 Abrasive caps, cylindrical round nose

302 Mandrel, cylindrical round nose

303 Abrasive caps, cylindrical pointed nose

304 Mandrel, cylindrical pointed nose

305 Abrasive caps, conical round nose

306 Mandrel, conical round nose

307 Abrasive sleeves, tapered

307 Mandrel, tapered

308 Abrasive caps, assortment

369 Power tools

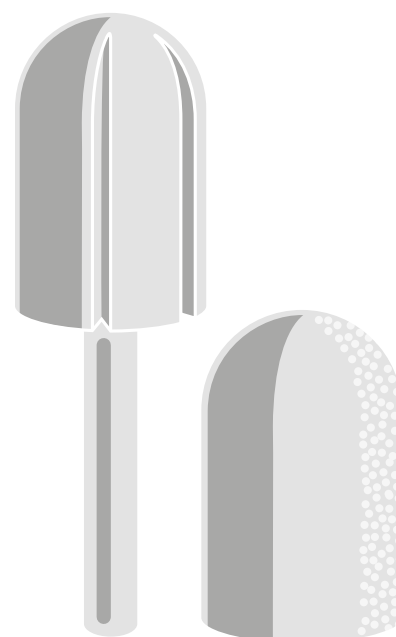

Grinding, Polishing
(flexible)

Product line marking

The product lines are illustrated by star symbols at the top of the table; please refer to page **14** and **15**.

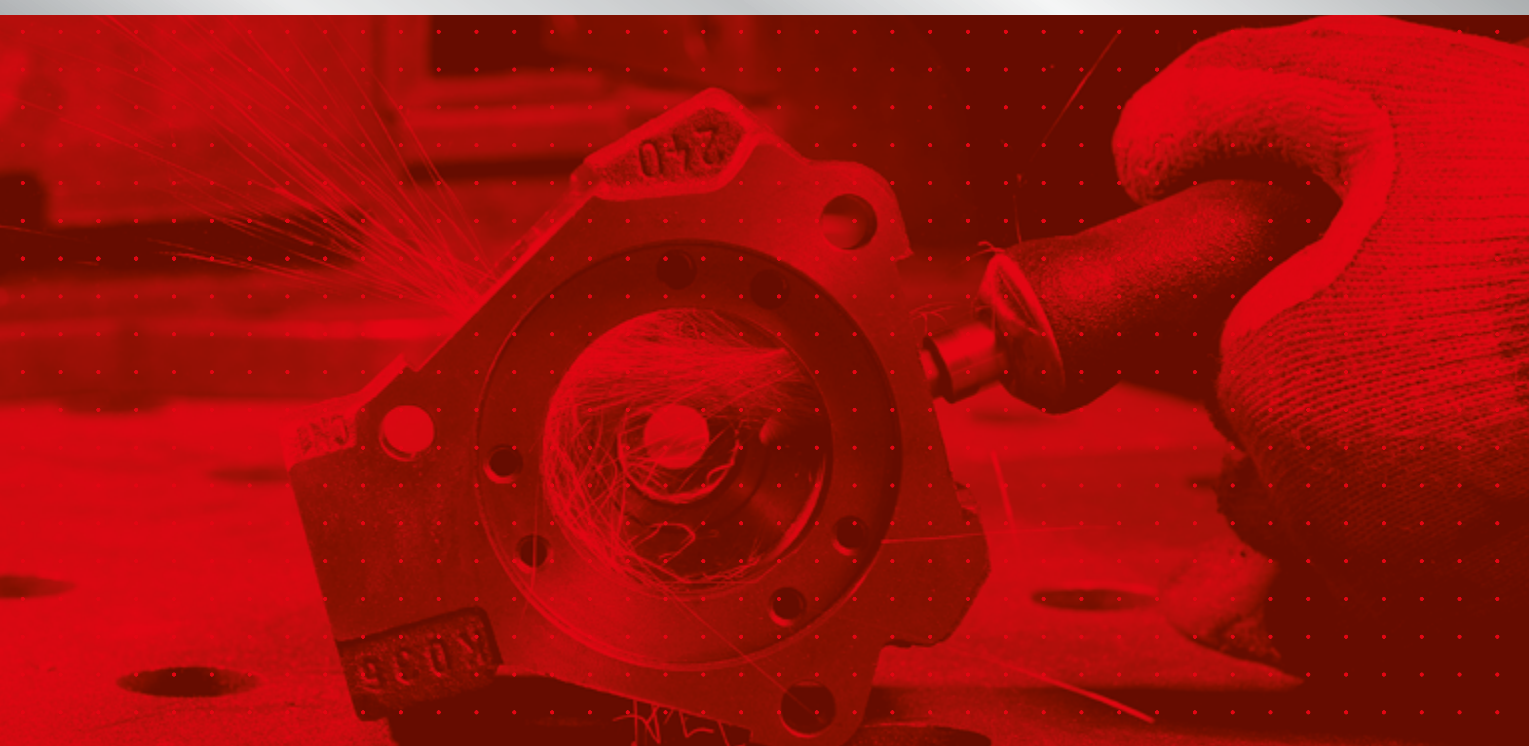

Information

The LUKAS abrasive caps and sleeves are manufactured from high quality coated abrasive material, and are used in conjunction with the appropriate high precision mandrel. We offer a great variety of different tools and mandrels which covers a wide spectrum of applications.

Examples of application:

- fine and extremely fine machining particularly in areas difficult to access
- tool, mould and model making

Maximum operating speed

The maximum operating speed for abrasive caps is stated in the respective table of mandrels. The indicated maximum operating speeds are only valid for a maximum overhang length of 15 mm. Other overhang dimensions must be calculated separately.

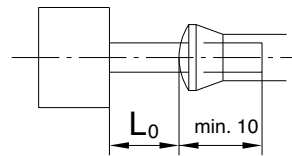

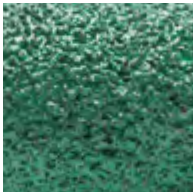

Abrasive caps, special, NKS

Special quality for the machining of corrosion and heat-resistant steels for tool and mould making. The top size coating with reactive fillers leads to higher stock removal and increased service life.

**☆



Abrasive caps, universal, NK

Universal quality for the machining of metal, plastics, wood and many other materials.

SKZYS, Abrasive caps special, Cylindrical shape

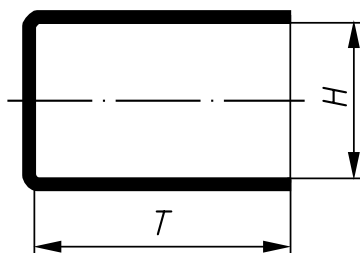

Ordering example: A21020051080

n_{max} : please refer to the corresponding mandrel, page 300



NKS = Aluminium Oxide with special coating

PG 8

Product number	Description	Grit	H mm	T mm	recommended for Information on page 438		
A21020051080	SKZYS 0510	NKS 80	5	10	① ② ③ ④ ⑤ ⑥ ⑦ ⑧	■	100
A21020051150	SKZYS 0510	NKS 150	5	10	① ② ③ ④ ⑤ ⑥ ⑦ ⑧	■	100
A21020071060	SKZYS 0712	NKS 60	7	12	① ② ③ ④ ⑤ ⑥ ⑦ ⑧	■	100
A21020071080	SKZYS 0712	NKS 80	7	12	① ② ③ ④ ⑤ ⑥ ⑦ ⑧	■	100
A21020071150	SKZYS 0712	NKS 150	7	12	① ② ③ ④ ⑤ ⑥ ⑦ ⑧	■	100
A21020101060	SKZYS 1015	NKS 60	10	15	① ② ③ ④ ⑤ ⑥ ⑦ ⑧	■	100
A21020101080	SKZYS 1015	NKS 80	10	15	① ② ③ ④ ⑤ ⑥ ⑦ ⑧	■	100
A21020101150	SKZYS 1015	NKS 150	10	15	① ② ③ ④ ⑤ ⑥ ⑦ ⑧	■	100

Grinding, Polishing (flexible)

SKZY, Abrasive caps universal, Cylindrical shape

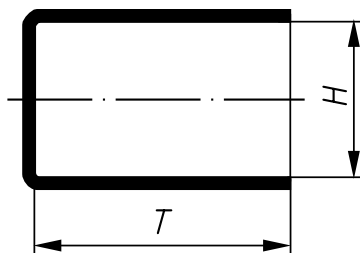

Ordering example: A21000051080

n_{max} : please refer to the corresponding mandrel, page 300



NK = reg. Aluminium Oxide

PG 9

Product number	Description	Grit	H mm	T mm	recommended for Information on page 438		
A21000051080	SKZY 0510	NK 80	5	10	① ② ③ ④ ⑤ ⑥ ⑦ ⑧	■	100
A21000051150	SKZY 0510	NK 150	5	10	① ② ③ ④ ⑤ ⑥ ⑦ ⑧	■	100
A21000051320	SKZY 0510	NK 320	5	10	① ② ③ ④ ⑤ ⑥ ⑦ ⑧	■	100
A21000071060	SKZY 0712	NK 60	7	12	① ② ③ ④ ⑤ ⑥ ⑦ ⑧	■	100
A21000071080	SKZY 0712	NK 80	7	12	① ② ③ ④ ⑤ ⑥ ⑦ ⑧	■	100
A21000071150	SKZY 0712	NK 150	7	12	① ② ③ ④ ⑤ ⑥ ⑦ ⑧	■	100
A21000071320	SKZY 0712	NK 320	7	12	① ② ③ ④ ⑤ ⑥ ⑦ ⑧	■	100
A21000101060	SKZY 1015	NK 60	10	15	① ② ③ ④ ⑤ ⑥ ⑦ ⑧	■	100
A21000101080	SKZY 1015	NK 80	10	15	① ② ③ ④ ⑤ ⑥ ⑦ ⑧	■	100
A21000101150	SKZY 1015	NK 150	10	15	① ② ③ ④ ⑤ ⑥ ⑦ ⑧	■	100

SKZY, Abrasive caps universal, Cylindrical shape

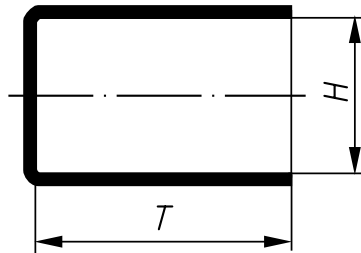

Ordering example: A21000051080

n_{max} : please refer to the corresponding mandrel, page 300

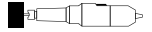

NK = reg. Aluminium Oxide

PG 9

Product number	Description	Grit	H mm	T mm	recommended for Information on page 438		
A21000101320	SKZY 1015	NK 320	10	15	① ② ③ ④ ⑤ ⑥ ⑦ ⑧	■	100
A21000131060	SKZY 1317	NK 60	13	17	① ② ③ ④ ⑤ ⑥ ⑦ ⑧	■	100
A21000131080	SKZY 1317	NK 80	13	17	① ② ③ ④ ⑤ ⑥ ⑦ ⑧	■	100
A21000131150	SKZY 1317	NK 150	13	17	① ② ③ ④ ⑤ ⑥ ⑦ ⑧	■	100
A21000131320	SKZY 1317	NK 320	13	17	① ② ③ ④ ⑤ ⑥ ⑦ ⑧	■	100
A21000161060	SKZY 1626	NK 60	16	26	① ② ③ ④ ⑤ ⑥ ⑦ ⑧	■	100
A21000161080	SKZY 1626	NK 80	16	26	① ② ③ ④ ⑤ ⑥ ⑦ ⑧	■	100
A21000161150	SKZY 1626	NK 150	16	26	① ② ③ ④ ⑤ ⑥ ⑦ ⑧	■	100
A21000161320	SKZY 1626	NK 320	16	26	① ② ③ ④ ⑤ ⑥ ⑦ ⑧	■	100

Grinding, Polishing
(flexible)

GTZY, Mandrel, Cylindrical shape

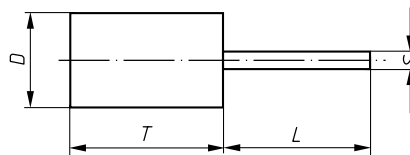

Ordering example: A250000511



PG 9

Product number	Description	D mm	T mm	Shank Ø x length mm	n max. (1/min)	recommended for Information on page 438		
A250000511	GTZY 0510	5	10	1/8" X 25	95.000		■	5
A250000512	GTZY 0510	5	10	2,35 X 40	57.000		■	5
A250000513	GTZY 0510	5	10	3 X 25	95.000		■	5
A250000712	GTZY 0712	7	12	2,35 X 40	42.000		■	5
A250000713	GTZY 0712	7	12	3 X 25	65.000		■	5
A250001011	GTZY 1015	10	15	1/8" X 25	45.000		■	5
A250001013	GTZY 1015	10	15	3 X 25	45.000		■	5
A250001313	GTZY 1317	13	17	3 X 25	35.000		■	5
A250001613	GTZY 1626	16	26	3 X 25	18.000		■	5
A250001616	GTZY 1626	16	26	6 X 40	30.000		■	5

SKWRS, Abrasive caps special, Cylindrical road nose

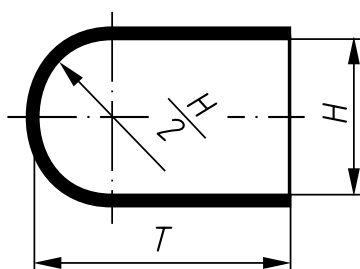

Ordering example: A21020052080

n_{max} : please refer to the corresponding mandrel, page 302



NKS = Aluminium Oxide with special coating

PG 8

Product number	Description	Grit	H mm	T mm	recommended for Information on page 438		
A21020052080	SKWRS 0511	NKS 80	5	11	① ② ③ ④ ⑤ ⑥ ⑦ ⑧	■	100
A21020052150	SKWRS 0511	NKS 150	5	11	① ② ③ ④ ⑤ ⑥ ⑦ ⑧	■	100
A21020072060	SKWRS 0713	NKS 60	7	13	① ② ③ ④ ⑤ ⑥ ⑦ ⑧	■	100
A21020072080	SKWRS 0713	NKS 80	7	13	① ② ③ ④ ⑤ ⑥ ⑦ ⑧	■	100
A21020072150	SKWRS 0713	NKS 150	7	13	① ② ③ ④ ⑤ ⑥ ⑦ ⑧	■	100
A21020102060	SKWRS 1015	NKS 60	10	15	① ② ③ ④ ⑤ ⑥ ⑦ ⑧	■	100
A21020102080	SKWRS 1015	NKS 80	10	15	① ② ③ ④ ⑤ ⑥ ⑦ ⑧	■	100
A21020102150	SKWRS 1015	NKS 150	10	15	① ② ③ ④ ⑤ ⑥ ⑦ ⑧	■	100
A21020132060	SKWRS 1319	NKS 60	13	19	① ② ③ ④ ⑤ ⑥ ⑦ ⑧	■	100
A21020132080	SKWRS 1319	NKS 80	13	19	① ② ③ ④ ⑤ ⑥ ⑦ ⑧	■	100
A21020132150	SKWRS 1319	NKS 150	13	19	① ② ③ ④ ⑤ ⑥ ⑦ ⑧	■	100

Grinding, Polishing
(flexible)

SKWR, Abrasive caps universal, Cylindrical road nose

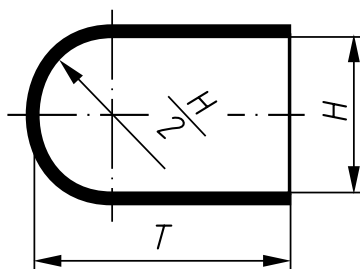

Ordering example: A21000052080

n_{max} : please refer to the corresponding mandrel, page 302



NK = reg. Aluminium Oxide

PG 9

Product number	Description	Grit	H mm	T mm	recommended for Information on page 438		
A21000052080	SKWR 0511	NK 80	5	11	① ② ③ ④ ⑤ ⑥ ⑦ ⑧	■	100
A21000052150	SKWR 0511	NK 150	5	11	① ② ③ ④ ⑤ ⑥ ⑦ ⑧	■	100
A21000052320	SKWR 0511	NK 320	5	11	① ② ③ ④ ⑤ ⑥ ⑦ ⑧	■	100
A21000072060	SKWR 0713	NK 60	7	13	① ② ③ ④ ⑤ ⑥ ⑦ ⑧	■	100
A21000072080	SKWR 0713	NK 80	7	13	① ② ③ ④ ⑤ ⑥ ⑦ ⑧	■	100
A21000072150	SKWR 0713	NK 150	7	13	① ② ③ ④ ⑤ ⑥ ⑦ ⑧	■	100
A21000072320	SKWR 0713	NK 320	7	13	① ② ③ ④ ⑤ ⑥ ⑦ ⑧	■	100
A21000102060	SKWR 1015	NK 60	10	15	① ② ③ ④ ⑤ ⑥ ⑦ ⑧	■	100
A21000102080	SKWR 1015	NK 80	10	15	① ② ③ ④ ⑤ ⑥ ⑦ ⑧	■	100
A21000102150	SKWR 1015	NK 150	10	15	① ② ③ ④ ⑤ ⑥ ⑦ ⑧	■	100
A21000102320	SKWR 1015	NK 320	10	15	① ② ③ ④ ⑤ ⑥ ⑦ ⑧	■	100

SKWR, Abrasive caps universal, Cylindrical road nose

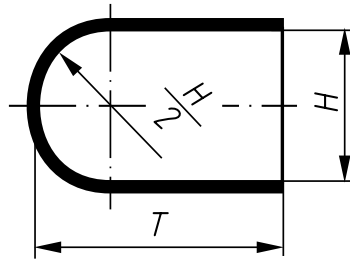

Ordering example: A21000052080

n_{max} : please refer to the corresponding mandrel, page 302

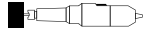

NK = reg. Aluminium Oxide

PG 9

Product number	Description	Grit	H mm	T mm	recommended for Information on page 438		
A21000132060	SKWR 1319	NK 60	13	19	① ② ③ ④ ⑤ ⑥ ⑦ ⑧	■	100
A21000132080	SKWR 1319	NK 80	13	19	① ② ③ ④ ⑤ ⑥ ⑦ ⑧	■	100
A21000132150	SKWR 1319	NK 150	13	19	① ② ③ ④ ⑤ ⑥ ⑦ ⑧	■	100
A21000132320	SKWR 1319	NK 320	13	19	① ② ③ ④ ⑤ ⑥ ⑦ ⑧	■	100
A21000162060	SKWR 1626	NK 60	16	26	① ② ③ ④ ⑤ ⑥ ⑦ ⑧	■	100
A21000162080	SKWR 1626	NK 80	16	26	① ② ③ ④ ⑤ ⑥ ⑦ ⑧	■	100
A21000162150	SKWR 1626	NK 150	16	26	① ② ③ ④ ⑤ ⑥ ⑦ ⑧	■	100
A21000162320	SKWR 1626	NK 320	16	26	① ② ③ ④ ⑤ ⑥ ⑦ ⑧	■	100

Grinding, Polishing
(flexible)

GTWR, Mandrel, Cylindrical road nose

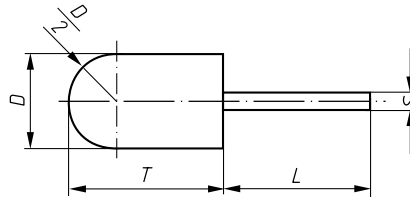

Ordering example: A250000521

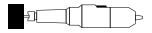

PG 9

Product number	Description	D mm	T mm	Shank \varnothing x length mm	n max. (1/min)	recommended for Information on page 438		
A250000521	GTWR 0511	5	11	1/8" X 25	95.000		■	5
A250000522	GTWR 0511	5	11	2,35 X 40	57.000		■	5
A250000523	GTWR 0511	5	11	3 X 25	95.000		■	5
A250000721	GTWR 0713	7	13	1/8" X 25	65.000		■	5
A250000722	GTWR 0713	7	13	2,35 X 40	42.000		■	5
A250000723	GTWR 0713	7	13	3 X 25	65.000		■	5
A250001021	GTWR 1015	10	15	1/8" X 25	45.000		■	5
A250001022	GTWR 1015	10	15	2,35 X 40	27.000		■	5
A250001023	GTWR 1015	10	15	3 X 25	45.000		■	5
A250001322	GTWR 1319	13	19	2,35 X 40	17.500		■	5
A250001323	GTWR 1319	13	19	3 X 25	35.000		■	5
A250001621	GTWR 1626	16	26	1/8" X 25	18.000		■	5
A250001622	GTWR 1626	16	26	2,35 X 40	11.000		■	5
A250001623	GTWR 1626	16	26	3 X 25	18.000		■	5
A250001626	GTWR 1626	16	26	6 X 40	30.000		■	5

SKWKS, Abrasive caps special, Cylindrical pointed nose

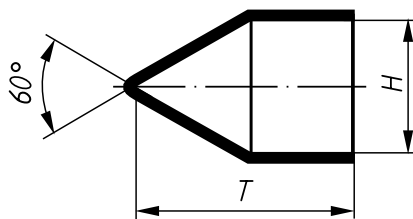

Ordering example: A21020053080

n_{max}: please refer to the corresponding mandrel, page 304



NKS = Aluminium Oxide with special coating

PG 8

Product number	Description	Grit	H mm	T mm	recommended for Information on page 438		
A21020053080	SKWKS 0511	NKS 80	5	11	① ② ③ ④ ⑤ ⑥ ⑦ ⑧	■	100
A21020053150	SKWKS 0511	NKS 150	5	11	① ② ③ ④ ⑤ ⑥ ⑦ ⑧	■	100
A21020073060	SKWKS 0713	NKS 60	7	13	① ② ③ ④ ⑤ ⑥ ⑦ ⑧	■	100
A21020073080	SKWKS 0713	NKS 80	7	13	① ② ③ ④ ⑤ ⑥ ⑦ ⑧	■	100
A21020073150	SKWKS 0713	NKS 150	7	13	① ② ③ ④ ⑤ ⑥ ⑦ ⑧	■	100
A21020103060	SKWKS 1015	NKS 60	10	15	① ② ③ ④ ⑤ ⑥ ⑦ ⑧	■	100
A21020103080	SKWKS 1015	NKS 80	10	15	① ② ③ ④ ⑤ ⑥ ⑦ ⑧	■	100
A21020103150	SKWKS 1015	NKS 150	10	15	① ② ③ ④ ⑤ ⑥ ⑦ ⑧	■	100
A21020133060	SKWKS 1319	NKS 60	13	19	① ② ③ ④ ⑤ ⑥ ⑦ ⑧	■	100
A21020133080	SKWKS 1319	NKS 80	13	19	① ② ③ ④ ⑤ ⑥ ⑦ ⑧	■	100
A21020133150	SKWKS 1319	NKS 150	13	19	① ② ③ ④ ⑤ ⑥ ⑦ ⑧	■	100

Grinding, Polishing
(flexible)

SKWK, Abrasive caps universal, Cylindrical pointed nose

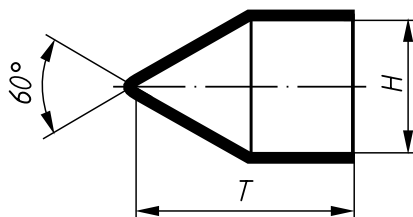

Ordering example: A21000053080

n_{max}: please refer to the corresponding mandrel, page 304



NK = reg. Aluminium Oxide

PG 9

Product number	Description	Grit	H mm	T mm	recommended for Information on page 438		
A21000053080	SKWK 0511	NK 80	5	11	① ② ③ ④ ⑤ ⑥ ⑦ ⑧	■	100
A21000053150	SKWK 0511	NK 150	5	11	① ② ③ ④ ⑤ ⑥ ⑦ ⑧	■	100
A21000053320	SKWK 0511	NK 320	5	11	① ② ③ ④ ⑤ ⑥ ⑦ ⑧	■	100
A21000073060	SKWK 0713	NK 60	7	13	① ② ③ ④ ⑤ ⑥ ⑦ ⑧	■	100
A21000073080	SKWK 0713	NK 80	7	13	① ② ③ ④ ⑤ ⑥ ⑦ ⑧	■	100
A21000073150	SKWK 0713	NK 150	7	13	① ② ③ ④ ⑤ ⑥ ⑦ ⑧	■	100
A21000073320	SKWK 0713	NK 320	7	13	① ② ③ ④ ⑤ ⑥ ⑦ ⑧	■	100
A21000103060	SKWK 1015	NK 60	10	15	① ② ③ ④ ⑤ ⑥ ⑦ ⑧	■	100
A21000103080	SKWK 1015	NK 80	10	15	① ② ③ ④ ⑤ ⑥ ⑦ ⑧	■	100

SKWK, Abrasive caps universal, Cylindrical pointed nose

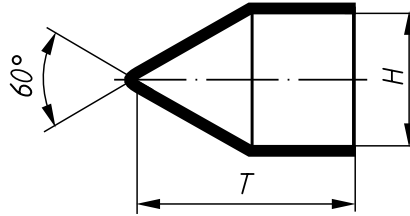

Ordering example: A21000053080

n max.: please refer to the corresponding mandrel, page 304

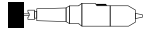

NK = reg. Aluminium Oxide

PG 9

Product number	Description	Grit	H mm	T mm	recommended for Information on page 438		
A21000103150	SKWK 1015	NK 150	10	15	① ② ③ ④ ⑤ ⑥ ⑦ ⑧	■	100
A21000103320	SKWK 1015	NK 320	10	15	① ② ③ ④ ⑤ ⑥ ⑦ ⑧	■	100
A21000133060	SKWK 1319	NK 60	13	19	① ② ③ ④ ⑤ ⑥ ⑦ ⑧	■	100
A21000133080	SKWK 1319	NK 80	13	19	① ② ③ ④ ⑤ ⑥ ⑦ ⑧	■	100
A21000133150	SKWK 1319	NK 150	13	19	① ② ③ ④ ⑤ ⑥ ⑦ ⑧	■	100
A21000133320	SKWK 1319	NK 320	13	19	① ② ③ ④ ⑤ ⑥ ⑦ ⑧	■	100
A21000163060	SKWK 1626	NK 60	16	26	① ② ③ ④ ⑤ ⑥ ⑦ ⑧	■	100
A21000163080	SKWK 1626	NK 80	16	26	① ② ③ ④ ⑤ ⑥ ⑦ ⑧	■	100
A21000163150	SKWK 1626	NK 150	16	26	① ② ③ ④ ⑤ ⑥ ⑦ ⑧	■	100
A21000163320	SKWK 1626	NK 320	16	26	① ② ③ ④ ⑤ ⑥ ⑦ ⑧	■	100

Grinding, Polishing
(flexible)

GTWK, Mandrel, Cylindrical pointed nose



Ordering example: A250000531

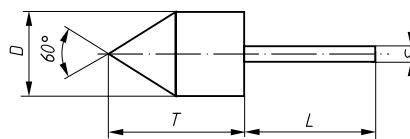

PG 9

Product number	Description	D mm	T mm	Shank Ø x length mm	n max. (1/min)	recommended for Information on page 438		
A250000531	GTWK 0511	5	11	1/8" X 25	95.000		■	5
A250000533	GTWK 0511	5	11	3 X 25	95.000		■	5
A250000732	GTWK 0713	7	13	2,35 X 40	42.000		■	5
A250000733	GTWK 0713	7	13	3 X 25	65.000		■	5
A250001033	GTWK 1015	10	15	3 X 25	45.000		■	5
A250001332	GTWK 1319	13	19	2,35 X 40	17.500		■	5
A250001333	GTWK 1319	13	19	3 X 25	35.000		■	5
A250001632	GTWK 1626	16	26	2,35 X 40	11.000		■	5
A250001633	GTWK 1626	16	26	3 X 25	18.000		■	5
A250001636	GTWK 1626	16	26	6 X 40	30.000		■	5

SKKES, Abrasive caps special, Conical road nose

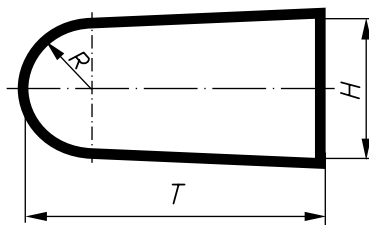

Ordering example: A2102163060

n_{max} : please refer to the corresponding mandrel, page 306



NKS = Aluminium Oxide with special coating

PG 8

Product number	Description	Grit	H mm	T mm	~R mm	recommended for Information on page 438		
A2102163060	SKKES 1632	NKS 60	16	32	7,5	① ② ③ ④ ⑤ ⑥ ⑦ ⑧	■	25
A2102163080	SKKES 1632	NKS 80	16	32	7,5	① ② ③ ④ ⑤ ⑥ ⑦ ⑧	■	25
A2102163150	SKKES 1632	NKS 150	16	32	7,5	① ② ③ ④ ⑤ ⑥ ⑦ ⑧	■	25

Grinding, Polishing (flexible)

SKKE, Abrasive caps universal, Conical road nose

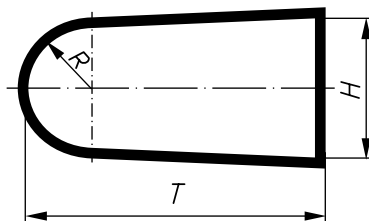

Ordering example: A2100051080

n_{max} : please refer to the corresponding mandrel, page 306



NK = reg. Aluminium Oxide

PG 9

Product number	Description	Grit	H mm	T mm	~R mm	recommended for Information on page 438		
A2100051080	SKKE 0515	NK 80	5	15	2	① ② ③ ④ ⑤ ⑥ ⑦ ⑧	■	100
A2100051150	SKKE 0515	NK 150	5	15	2	① ② ③ ④ ⑤ ⑥ ⑦ ⑧	■	100
A2100051280	SKKE 0515	NK 280	5	15	2	① ② ③ ④ ⑤ ⑥ ⑦ ⑧	■	100
A2100112060	SKKE 1125	NK 60	11	25	5	① ② ③ ④ ⑤ ⑥ ⑦ ⑧	■	100
A2100112080	SKKE 1125	NK 80	11	25	5	① ② ③ ④ ⑤ ⑥ ⑦ ⑧	■	100
A2100112150	SKKE 1125	NK 150	11	25	5	① ② ③ ④ ⑤ ⑥ ⑦ ⑧	■	100
A2100112280	SKKE 1125	NK 280	11	25	5	① ② ③ ④ ⑤ ⑥ ⑦ ⑧	■	100
A2100163060	SKKE 1632	NK 60	16	32	7,5	① ② ③ ④ ⑤ ⑥ ⑦ ⑧	■	25
A2100163080	SKKE 1632	NK 80	16	32	7,5	① ② ③ ④ ⑤ ⑥ ⑦ ⑧	■	25
A2100163150	SKKE 1632	NK 150	16	32	7,5	① ② ③ ④ ⑤ ⑥ ⑦ ⑧	■	25
A2100163280	SKKE 1632	NK 280	16	32	7,5	① ② ③ ④ ⑤ ⑥ ⑦ ⑧	■	25
A2100224060	SKKE 2140	NK 60	21	40	9,5	① ② ③ ④ ⑤ ⑥ ⑦ ⑧	■	25
A2100224080	SKKE 2140	NK 80	21	40	9,5	① ② ③ ④ ⑤ ⑥ ⑦ ⑧	■	25
A2100224150	SKKE 2140	NK 150	21	40	9,5	① ② ③ ④ ⑤ ⑥ ⑦ ⑧	■	25
A2100224280	SKKE 2140	NK 280	21	40	9,5	① ② ③ ④ ⑤ ⑥ ⑦ ⑧	■	25

GTKE, Mandrel, Conical road nose

★★☆

Ordering example: A25000511

Change of shank length „L” reserved.

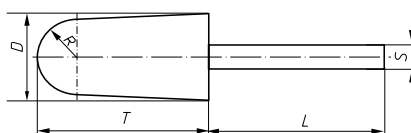

PG 9

Product number	Description	D mm	T mm	L mm	~R mm	Shank Ø x length mm	n max. (1/min)	recommended for Information on page 438		
A25000511	GTKE 0515	5	15	40	2	1/4" X 40	95.000		■	5
A25000513	GTKE 0515	5	15	40	2	3 X 25	57.000		■	5
A25000516	GTKE 0515	5	15	40	2	6 X 40	95.000		■	5
A25001126	GTKE 1125	11	25	40	5	6 X 40	40.000		■	5
A650011220002	GTKE 1125	11	25	40	5	S2,35x40	40.000		■	5
A25001636	GTKE 1632	16	32	40	7,5	6 X 40	30.000		■	5
A25002246	GTKE 2140	21	40	40	9,5	6 X 40	20.000		■	5

Grinding, Polishing (flexible)

SHKE, Abrasive sleeves, Conical shape

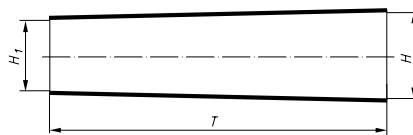

Ordering example: A2101108080

n max.: please refer to the corresponding mandrel, page 307



NK = reg. Aluminium Oxide

PG 8

Product number	Description	Grit	H mm	T mm	H ₁ mm	recommended for		
						Information on page 438		
A2101108080	SHKE 0885	NK 80	8	85	4,5	① ② ③ ④ ⑤ ⑥ ⑦ ⑧	■	25
A2101108150	SHKE 0885	NK 150	8	85	4,5	① ② ③ ④ ⑤ ⑥ ⑦ ⑧	■	25
A2101158080	SHKE 1385	NK 80	13	85	9,5	① ② ③ ④ ⑤ ⑥ ⑦ ⑧	■	25
A2101158150	SHKE 1385	NK 150	13	85	9,5	① ② ③ ④ ⑤ ⑥ ⑦ ⑧	■	25
A2101208080	SHKE 1885	NK 80	18	85	14,5	① ② ③ ④ ⑤ ⑥ ⑦ ⑧	■	25
A2101208150	SHKE 1885	NK 150	18	85	14,5	① ② ③ ④ ⑤ ⑥ ⑦ ⑧	■	25
A2101258080	SHKE 2385	NK 80	23	85	19,5	① ② ③ ④ ⑤ ⑥ ⑦ ⑧	■	25
A2101258150	SHKE 2385	NK 150	23	85	19,5	① ② ③ ④ ⑤ ⑥ ⑦ ⑧	■	25

Grinding, Polishing (flexible)

GTKE, Mandrel, Conical shape

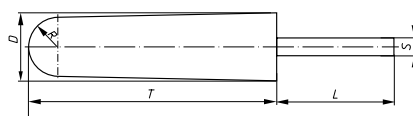

Ordering example: A25001086



PG 9

Product number	Description	D mm	T mm	L mm	~R mm	Shank Ø x length mm	n max. (1/min)	recommended for		
								Information on page 438		
A25001086	GTKE 0885	8	85	40	2	6 X 40	24.000		■	5
A25001586	GTKE 1385	13	85	40	5	6 X 40	17.000		■	5
A25002086	GTKE 1885	18	85	40	7,5	6 X 40	12.000		■	5
A25002586	GTKE 2385	23	85	40	9,5	6 X 40	10.000		■	5

For inaccessible areas, use abrasive caps conical shape (see page 305) in conjunction with a mandrel of head length 85 mm.

Abrasive caps-Assortments



Ordering example: A210000065

Assortment containing:
640 pcs. Abrasive Caps
23 pcs. Mandrels



Outside dimension of box:
372 x 189 x 46 mm

NK = regular Aluminium Oxide

PG 9

Product number	Description	piece	Contents	recommended for	Information on page 438									
A210000065	WS 65	50 pcs. 100 pcs. of 50 pcs. of 20 pcs. of 10 pcs.	Abrasive Caps, grit NK 150 SKKE 0515 SKZY 0510, SKWR 0511, SKWK 0511 SKZY 0712, SKWR 0713, SKWK 0713 SKZY 1015, SKWR 1015 SKKE 1125 Abrasive Caps, grit NK 80 SKWK 1015 SKZY 1317, SKWR 1319, SKWK 1319, SKKE 1632 SKWK 1626, SKWR 1626 Mandrels, Shank 3 mm GTZY 0510, GTWR 0511, GTWK 0511, GTZY 0712, GTWR 0713, GTWK 0713 GTZY 1015, GTWR 1015, GTWK 1015, GTZY 1317, GTWR 1319, GTWK 1319 Mandrels, Shank 6 mm GTKE 0515, GTKE 1125, GTWK 1626, GTWR 1626, GTKE 1632	① ② ③ ④ ⑤ ⑥ ⑦ ⑧	■	1								

Grinding, Polishing
(flexible)

Abrasive Discs and Mandrels

310 Qualities and Applications

311 General Information

312 Abrasive discs, quick-change type

317 Mandrels for quick-change abrasive discs

319 Abrasive discs with plastic thread,
quick-change type

320 Flap Discs, quick-change type

321 Mandrels with plastic thread, quick-change type

322 Abrasive discs, self-adhesive

323 Mandrels for self-adhesive abrasive discs

324 Abrasive discs, self-fixing

325 Mandrels for self-fixing abrasive discs

369 Power tool

Product line marking

The product lines are illustrated by star symbols at the top of the table; please refer to page **14** and **15**.

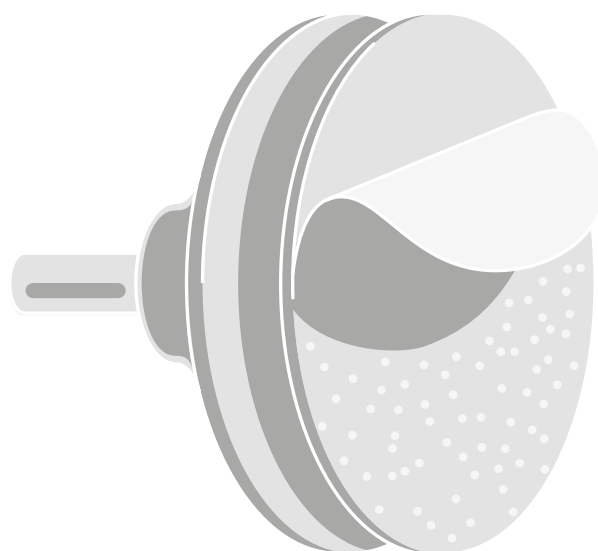

Grinding, Polishing
(flexible)

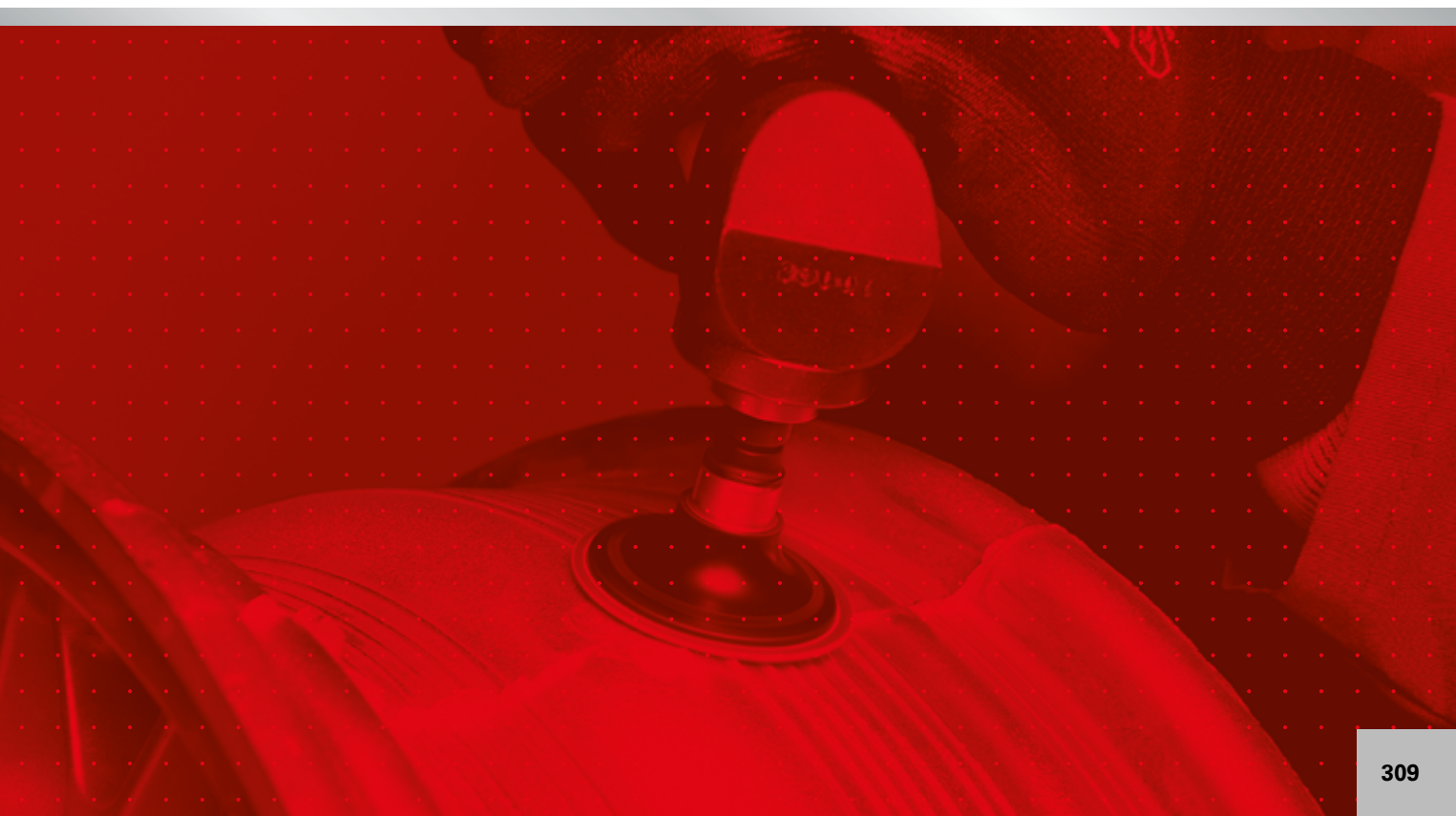

Information

Abrasive Discs, quick-change type, PSG/PSR

LUKAS-Abrasive discs- PSG/PSR- are designed for quick mounting; a quick locking metal centre is integrated into the backing of the abrasive disc. A quick twisting movement secures the disc to the mandrel. The PSG abrasive disc provides us with the most comprehensive selection in this product group. A choice of diameter, different grit sizes and qualities covering every imaginable application, helps solve your particular grinding problem.

Abrasive Discs, self-adhesive PSK









LUKAS abrasive discs PSK are self-adhesive. The adhesive backing of the disc is covered with a protective foil; after the removal of the foil the disc can be fixed to the rubber mandrel. The self-adhesive LUKAS abrasive discs can be used on a wide variety of surfaces. After the removal of the disc from the backing, the disc cannot be re-used. The self-adhesive discs are available in various grit sizes of regular aluminium oxide (NK) as detailed on following pages.

Abrasive Discs, self-fixing PSH

LUKAS abrasive discs PSH are self-fixing. The back face and the front face of the rubber mandrel are coated with Velcro. The self-fixing LUKAS abrasive discs can be used on both flat and curved surfaces. Due to the velcro fixing, a partly worn disc can easily be removed and re-used at a later date. The self-fixing abrasive discs are available in various grit sizes of regular aluminium oxide (NK), as detailed on following pages.

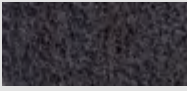

PSG, Qualities and Applications

Quality		Characteristics	Applications	Page
 NK	Abrasive cloth with reg. Aluminium Oxide	tough grain	Universal grinding and deburring	314
 NKE	Abrasive cloth using reg. Aluminium Oxide with special coating	tough grain	Due to the reinforcement suited even for highest demands and edge working.	315
 ZK	Abrasive cloth with Zirconia Alum. Oxide	very tough and resilient grain	Ideal for Hastelloy, Inconel, stainless steels and all metals difficult to machine.	313
 Z POWER	Zirconia Alum. Oxide with active grinding additives	optimum stock removal rate, excellent tool life	Ideal for stainless. Special tosize coating prevents clogging.	313
 Ceramic	Abrasive cloth ceramic grain	optimum stock removal rate without shredding of grain. Very stable due to reinforced backing. Cool cutting	Ideal for stainless and nickel alloys.	312
 SIC	Abrasive cloth with Silicon carbide	cool cutting; special quality for the aircraft industry	Ideal for titanium, titanium alloys and aluminium (aerospace industry). Also suitable for plastic and ceramic materials.	315
	Fleece Reg. Aluminium oxide coarse/brown	Polishing effect through the fibre structure, constant working results due to steadily discharge of abrasive particles. Outstanding tool life.	Ideal for removing rust or paint, scratches and pre-machining marks. A general improvement of the surface finish.	316
	medium/red-brown			
	fine/blue			

PSG, Abrasive Discs, quick-change, Ceramic grain

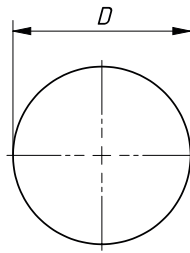
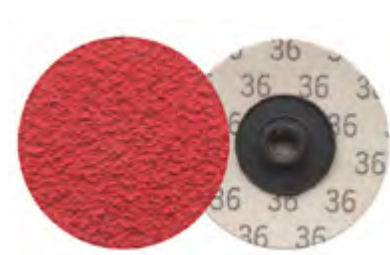

Ordering example: A3379038036

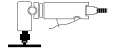

PG 8

Product number	Description	Quality/Grit	D mm	n max. (1/min)	Suitable carriers	recommended for							Information on page 438	Image
						2	3	4	5	7				
A3379038036	PSG 038	Ceramic 36	38	30.000	GTG 038	2	3	4	5	7			■	100
A3379038060	PSG 038	Ceramic 60	38	30.000	GTG 038	2	3	4	5	7			■	100
A3379038080	PSG 038	Ceramic 80	38	30.000	GTG 038	2	3	4	5	7			■	100
A3379038120	PSG 038	Ceramic 120	38	30.000	GTG 038	2	3	4	5	7			■	100
A3379050036	PSG 050	Ceramic 36	50	30.000	GTG 038 and GTG 050	2	3	4	5	7			■	100
A3379050060	PSG 050	Ceramic 60	50	30.000	GTG 038 and GTG 050	2	3	4	5	7			■	100
A3379050080	PSG 050	Ceramic 80	50	30.000	GTG 038 and GTG 050	2	3	4	5	7			■	100
A3379050120	PSG 050	Ceramic 120	50	30.000	GTG 038 and GTG 050	2	3	4	5	7			■	100
A3379075036	PSG 075	Ceramic 36	75	20.000	GTG 075	2	3	4	5	7			■	50
A3379075060	PSG 075	Ceramic 60	75	20.000	GTG 075	2	3	4	5	7			■	50
A3379075080	PSG 075	Ceramic 80	75	20.000	GTG 075	2	3	4	5	7			■	50
A3379075120	PSG 075	Ceramic 120	75	20.000	GTG 075	2	3	4	5	7			■	50

Grinding, Polishing (flexible)

PSG, Abrasive Discs, quick-change, Zirconia Alum. Oxide with active grinding additives

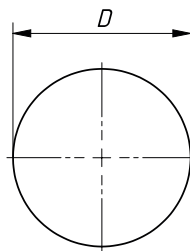
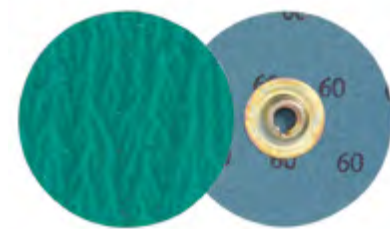

Ordering example: A3377038036

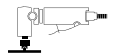

PG 8

Product number	Description	Quality/Grit	D mm	n max. (1/min)	Suitable carriers	recommended for							Information on page 438	Image	
						1	2	3	4	5	7				
A3377038036	PSG 038	Z Power 36	38	30.000	GTG 038	1	2	3	4	5	7			■	100
A3377038060	PSG 038	Z Power 60	38	30.000	GTG 038	1	2	3	4	5	7			■	100
A3377038080	PSG 038	Z Power 80	38	30.000	GTG 038	1	2	3	4	5	7			■	100
A3377038120	PSG 038	Z Power 120	38	30.000	GTG 038	1	2	3	4	5	7			■	100
A3377050036	PSG 050	Z Power 36	51	30.000	GTG 038 and GTG 050	1	2	3	4	5	7			■	100
A3377050060	PSG 050	Z Power 60	51	30.000	GTG 038 and GTG 050	1	2	3	4	5	7			■	100
A3377050080	PSG 050	Z Power 80	51	30.000	GTG 038 and GTG 050	1	2	3	4	5	7			■	100
A3377050120	PSG 050	Z Power 120	51	30.000	GTG 038 and GTG 050	1	2	3	4	5	7			■	100

PSG, Abrasive Discs, quick-change, Zirconia Alum. Oxide with active grinding additives



Ordering example: A3377038036

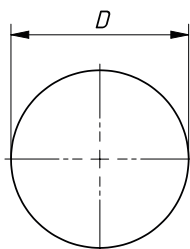
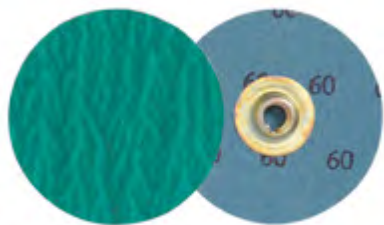

PG 8

Product number	Description	Quality/Grit	D mm	n max. (1/min)	Suitable carriers	recommended for Information on page 438		
A3377075036	PSG 075	Z Power 36	76	20.000	GTG 075	1 2 3 4 5 7	■	50
A3377075060	PSG 075	Z Power 60	76	20.000	GTG 075	1 2 3 4 5 7	■	50
A3377075080	PSG 075	Z Power 80	76	20.000	GTG 075	1 2 3 4 5 7	■	50
A3377075120	PSG 075	Z Power 120	76	20.000	GTG 075	1 2 3 4 5 7	■	50

PSG, Abrasive Discs, quick-change, Zirconia Alum. Oxide



Ordering example: A3353025060

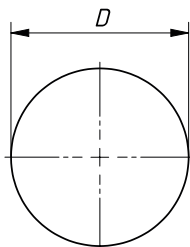
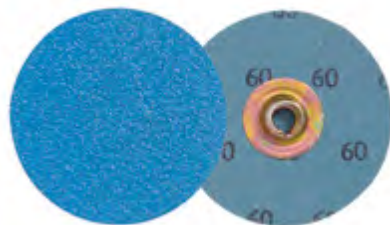
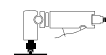

PG 8

Product number	Description	Quality/Grit	D mm	n max. (1/min)	Suitable carriers	recommended for Information on page 438		
A3353025060	PSG 025	ZK 60	25	40.000	GTG 025	1 2 3 4 5 7	■	100
A3353025080	PSG 025	ZK 80	25	40.000	GTG 025	1 2 3 4 5 7	■	100
A3353038060	PSG 038	ZK 60	38	30.000	GTG 038	1 2 3 4 5 7	■	100
A3353038080	PSG 038	ZK 80	38	30.000	GTG 038	1 2 3 4 5 7	■	100
A3353050036	PSG 050	ZK 36	51	30.000	GTG 038 and GTG 050	1 2 3 4 5 7	■	100
A3353050060	PSG 050	ZK 60	51	30.000	GTG 038 and GTG 050	1 2 3 4 5 7	■	100
A3353050080	PSG 050	ZK 80	51	30.000	GTG 038 and GTG 050	1 2 3 4 5 7	■	100
A3353075036	PSG 075	ZK 36	76	20.000	GTG 075	1 2 3 4 5 7	■	50
A3353075060	PSG 075	ZK 60	76	20.000	GTG 075	1 2 3 4 5 7	■	50
A3353075080	PSG 075	ZK 80	76	20.000	GTG 075	1 2 3 4 5 7	■	50

PSG, Abrasive Discs, quick-change, reg. Aluminium Oxide

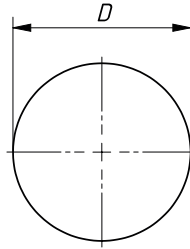
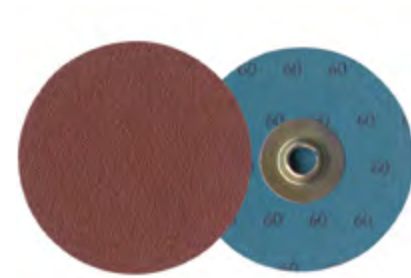

Ordering example: A3351020060

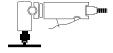

PG 8

Product number	Description	Quality/Grit	D mm	n max. (1/min)	Suitable carriers	recommended for Information on page 438		
A3351020060	PSG 020	NK 60	19	40.000	GTG 020	① ② ③ ④ ⑤ ⑥ ⑦ ⑧	■	100
A3351020080	PSG 020	NK 80	19	40.000	GTG 020	① ② ③ ④ ⑤ ⑥ ⑦ ⑧	■	100
A3351020120	PSG 020	NK 120	19	40.000	GTG 020	① ② ③ ④ ⑤ ⑥ ⑦ ⑧	■	100
A3351025036	PSG 025	NK 36	25	40.000	GTG 025	① ② ③ ④ ⑤ ⑥ ⑦ ⑧	■	100
A3351025060	PSG 025	NK 60	25	40.000	GTG 025	① ② ③ ④ ⑤ ⑥ ⑦ ⑧	■	100
A3351025080	PSG 025	NK 80	25	40.000	GTG 025	① ② ③ ④ ⑤ ⑥ ⑦ ⑧	■	100
A3351025120	PSG 025	NK 120	25	40.000	GTG 025	① ② ③ ④ ⑤ ⑥ ⑦ ⑧	■	100
A3351038036	PSG 038	NK 36	38	30.000	GTG 038	① ② ③ ④ ⑤ ⑥ ⑦ ⑧	■	100
A3351038060	PSG 038	NK 60	38	30.000	GTG 038	① ② ③ ④ ⑤ ⑥ ⑦ ⑧	■	100
A3351038080	PSG 038	NK 80	38	30.000	GTG 038	① ② ③ ④ ⑤ ⑥ ⑦ ⑧	■	100
A3351038120	PSG 038	NK 120	38	30.000	GTG 038	① ② ③ ④ ⑤ ⑥ ⑦ ⑧	■	100
A3351038180	PSG 038	NK 180	38	30.000	GTG 038	① ② ③ ④ ⑤ ⑥ ⑦ ⑧	■	100
A3351038240	PSG 038	NK 240	38	30.000	GTG 038	① ② ③ ④ ⑤ ⑥ ⑦ ⑧	■	100
A3351050036	PSG 050	NK 36	51	30.000	GTG 038 and GTG 050	① ② ③ ④ ⑤ ⑥ ⑦ ⑧	■	100
A3351050050	PSG 050	NK 50	51	30.000	GTG 038 and GTG 050	① ② ③ ④ ⑤ ⑥ ⑦ ⑧	■	100
A3351050060	PSG 050	NK 60	51	30.000	GTG 038 and GTG 050	① ② ③ ④ ⑤ ⑥ ⑦ ⑧	■	100
A3351050080	PSG 050	NK 80	51	30.000	GTG 038 and GTG 050	① ② ③ ④ ⑤ ⑥ ⑦ ⑧	■	100
A3351050120	PSG 050	NK 120	51	30.000	GTG 038 and GTG 050	① ② ③ ④ ⑤ ⑥ ⑦ ⑧	■	100
A3351050180	PSG 050	NK 180	51	30.000	GTG 038 and GTG 050	① ② ③ ④ ⑤ ⑥ ⑦ ⑧	■	100
A3351050240	PSG 050	NK 240	51	30.000	GTG 038 and GTG 050	① ② ③ ④ ⑤ ⑥ ⑦ ⑧	■	100
A3351075036	PSG 075	NK 36	76	20.000	GTG 075	① ② ③ ④ ⑤ ⑥ ⑦ ⑧	■	50
A3351075060	PSG 075	NK 60	76	20.000	GTG 075	① ② ③ ④ ⑤ ⑥ ⑦ ⑧	■	50
A3351075080	PSG 075	NK 80	76	20.000	GTG 075	① ② ③ ④ ⑤ ⑥ ⑦ ⑧	■	50
A3351075120	PSG 075	NK 120	76	20.000	GTG 075	① ② ③ ④ ⑤ ⑥ ⑦ ⑧	■	50
A3351075180	PSG 075	NK 180	76	20.000	GTG 075	① ② ③ ④ ⑤ ⑥ ⑦ ⑧	■	50

Grinding, Polishing
(flexible)

PSG, Abrasive Discs, quick-change, reg. Aluminium Oxide with special coating

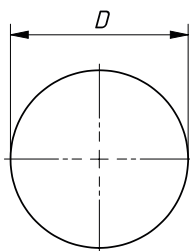
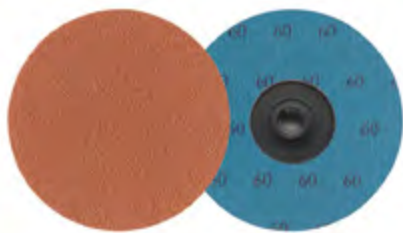

Ordering example: A3352025060



								PG 8	
Product number	Description	Quality/Grit	D mm	n max. (1/min)	Suitable carriers	recommended for			
							Information on page 438		
A3352025060	PSG 025	NKE 60	25	40.000	GTG 025	① ② ③ ④ ⑤ ⑥ ⑦ ⑧	■		100
A3352025080	PSG 025	NKE 80	25	40.000	GTG 025	① ② ③ ④ ⑤ ⑥ ⑦ ⑧	■		100
A3352025120	PSG 025	NKE 120	25	40.000	GTG 025	① ② ③ ④ ⑤ ⑥ ⑦ ⑧	■		100
A3352025180	PSG 025	NKE 180	25	40.000	GTG 025	① ② ③ ④ ⑤ ⑥ ⑦ ⑧	■		100
A3352025240	PSG 025	NKE 240	25	40.000	GTG 025	① ② ③ ④ ⑤ ⑥ ⑦ ⑧	■		100
A3352038060	PSG 038	NKE 60	38	30.000	GTG 038	① ② ③ ④ ⑤ ⑥ ⑦ ⑧	■		100
A3352038080	PSG 038	NKE 80	38	30.000	GTG 038	① ② ③ ④ ⑤ ⑥ ⑦ ⑧	■		100
A3352038120	PSG 038	NKE 120	38	30.000	GTG 038	① ② ③ ④ ⑤ ⑥ ⑦ ⑧	■		100
A3352050036	PSG 050	NKE 36	51	30.000	GTG 038 and GTG 050	① ② ③ ④ ⑤ ⑥ ⑦ ⑧	■		100
A3352050060	PSG 050	NKE 60	51	30.000	GTG 038 and GTG 050	① ② ③ ④ ⑤ ⑥ ⑦ ⑧	■		100
A3352050080	PSG 050	NKE 80	51	30.000	GTG 038 and GTG 050	① ② ③ ④ ⑤ ⑥ ⑦ ⑧	■		100
A3352050120	PSG 050	NKE 120	51	30.000	GTG 038 and GTG 050	① ② ③ ④ ⑤ ⑥ ⑦ ⑧	■		100
A3352050180	PSG 050	NKE 180	51	30.000	GTG 038 and GTG 050	① ② ③ ④ ⑤ ⑥ ⑦ ⑧	■		100
A3352050240	PSG 050	NKE 240	51	30.000	GTG 038 and GTG 050	① ② ③ ④ ⑤ ⑥ ⑦ ⑧	■		100
A3352075060	PSG 075	NKE 60	76	20.000	GTG 075	① ② ③ ④ ⑤ ⑥ ⑦ ⑧	■		50
A3352075080	PSG 075	NKE 80	76	20.000	GTG 075	① ② ③ ④ ⑤ ⑥ ⑦ ⑧	■		50

Grinding, Polishing (flexible)

PSG, Abrasive Discs, quick-change, Silicon carbide

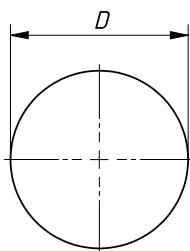
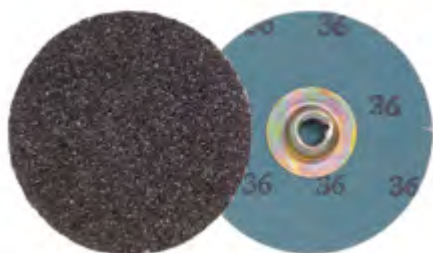

Ordering example: A3378038036

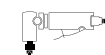

								PG 8	
Product number	Description	Quality/Grit	D mm	n max. (1/min)	Suitable carriers	recommended for			
							Information on page 438		
A3378038036	PSG 038	SIC 36	38	30.000	GTG 038	① ② ③ ④ ⑤ ⑥ ⑦ ⑧ ⑨	■		100
A3378038060	PSG 038	SIC 60	38	30.000	GTG 038	① ② ③ ④ ⑤ ⑥ ⑦ ⑧ ⑨	■		100
A3378038080	PSG 038	SIC 80	38	30.000	GTG 038	① ② ③ ④ ⑤ ⑥ ⑦ ⑧ ⑨	■		100

PSG, Abrasive Discs, quick-change, Silicon carbide

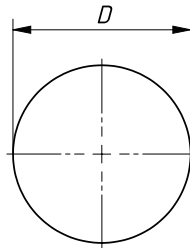
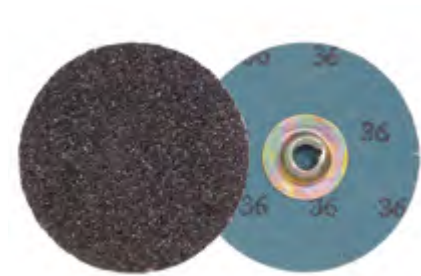

Ordering example: A3378038036

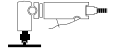

PG 8

Product number	Description	Quality/Grit	D mm	n max. (1/min)	Suitable carriers	recommended for Information on page 438		
A3378038120	PSG 038	SIC 120	38	30.000	GTG 038	① ② ③ ④ ⑤ ⑥ ⑦ ⑧ ⑨	■	100
A3378050036	PSG 050	SIC 36	51	30.000	GTG 038 and GTG 050	① ② ③ ④ ⑤ ⑥ ⑦ ⑧ ⑨	■	100
A3378050060	PSG 050	SIC 60	51	30.000	GTG 038 and GTG 050	① ② ③ ④ ⑤ ⑥ ⑦ ⑧ ⑨	■	100
A3378050080	PSG 050	SIC 80	51	30.000	GTG 038 and GTG 050	① ② ③ ④ ⑤ ⑥ ⑦ ⑧ ⑨	■	100
A3378050120	PSG 050	SIC 120	51	30.000	GTG 038 and GTG 050	① ② ③ ④ ⑤ ⑥ ⑦ ⑧ ⑨	■	100
A3378075036	PSG 075	SIC 36	76	20.000	GTG 075	① ② ③ ④ ⑤ ⑥ ⑦ ⑧ ⑨	■	50
A3378075060	PSG 075	SIC 60	76	20.000	GTG 075	① ② ③ ④ ⑤ ⑥ ⑦ ⑧ ⑨	■	50
A3378075080	PSG 075	SIC 80	76	20.000	GTG 075	① ② ③ ④ ⑤ ⑥ ⑦ ⑧ ⑨	■	50

Grinding, Polishing
(flexible)

PSG, Abrasive discs, quick-change, Fleece Reg. Aluminium oxide

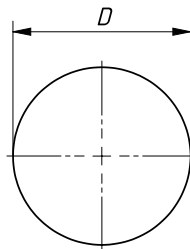
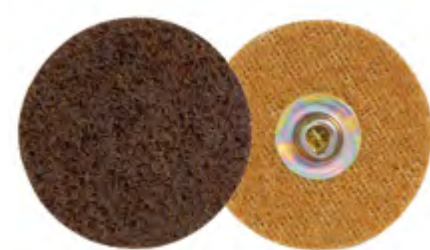

Ordering example: A3374038002



PG 8

Product number	Description	Quality/Grit	D mm	n max. (1/min)	Suitable carriers	recommended for Information on page 438		
A3374038005	PSG 038	Fleece fine	38	10.000	GTG 038	① ② ③ ④ ⑤ ⑥ ⑦ ⑧	■	50
A3374038004	PSG 038	Fleece coarse	38	10.000	GTG 038	① ② ③ ④ ⑤ ⑥ ⑦ ⑧	■	50
A3374038002	PSG 038	Fleece medium	38	10.000	GTG 038	① ② ③ ④ ⑤ ⑥ ⑦ ⑧	■	50
A3374050005	PSG 050	Fleece fine	50	8.000	GTG 038 and GTG 050	① ② ③ ④ ⑤ ⑥ ⑦ ⑧	■	50
A3374050004	PSG 050	Fleece coarse	50	8.000	GTG 038 and GTG 050	① ② ③ ④ ⑤ ⑥ ⑦ ⑧	■	50
A3374050002	PSG 050	Fleece medium	50	8.000	GTG 038 and GTG 050	① ② ③ ④ ⑤ ⑥ ⑦ ⑧	■	50
A3374075005	PSG 075	Fleece fine	75	5.500	GTG 075	① ② ③ ④ ⑤ ⑥ ⑦ ⑧	■	25
A3374075004	PSG 075	Fleece coarse	75	5.500	GTG 075	① ② ③ ④ ⑤ ⑥ ⑦ ⑧	■	25
A3374075002	PSG 075	Fleece medium	75	5.500	GTG 075	① ② ③ ④ ⑤ ⑥ ⑦ ⑧	■	25

GTG, Mandrels for quick-change abrasive discs

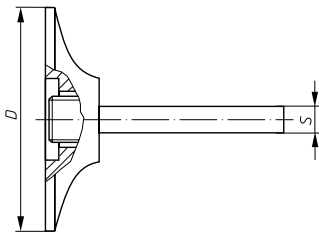

Ordering example: A33500200026

n_{max} : please also refer to Abrasive discs, PSG, page 312–316



PG 8

Product number	Description	D mm	S mm	Type	n max. (1/min)	recommended for Information on page 438		
A33500200026	GTG 020.06	18	6	Medium	40.000		■	1
A33500250026	GTG 025.06	23	6	Medium	40.000		■	1
A33500380026	GTG 038.06	33	6	Medium	25.000		■	1
A33500500026	GTG 050.06	45	6	Medium	25.000		■	1
A33500500036	GTG 050.06	45	6	Hard	30.000		■	1
A33500750026	GTG 075.06	70	6	Medium	20.000		■	1
A33500750036	GTG 075.06	70	6	Hard	20.000		■	1



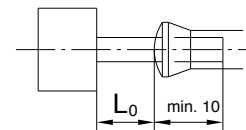

The mandrels are supplied in a **medium** hardness for universal application. For severe applications (when using Z Power and Ceramic please use **hard** quality mandrels.

The stated maximum operating speed is calculated using the maximum mandrel diameter and maximum overhang L_0 of 5 mm. For other overhangs and smaller mandrel diameters, the maximum operating speed must be re-calculated.



Grinding, Polishing (flexible)

PSR, Qualities and Applications

Quality	Characteristics	Applications	Page
 Abrasive cloth with Zirconia Alum. Oxide ZK	very tough and resilient grain	Ideal for hastelloy, inconel, stainless and steels difficult to machine.	313
 Fleece Reg. Aluminium oxide coarse/brown  medium/red-brown  fine/blue	Polishing effect through the fibre structure, constant working results due to steadily discharge of abrasive particles. Outstanding tool life.	Ideal for removing rust or paint, scratches and pre-machining marks. A general improvement of the surface finish.	316

Grinding, Polishing (flexible)

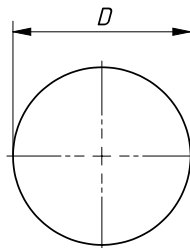
PSR, Abrasive Discs with plastic thread, quick-change

Ordering example: A3363038060

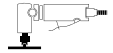
PG 8

Product number	Description	Quality/Grit	D mm	n max. (1/min)	Suitable carriers	recommended for Information on page 438		
A3363038060	PSR 038	ZK 60	38	30.000	GTR 038	① ② ③ ④ ⑤ ⑦	■	100
A3363038080	PSR 038	ZK 80	38	30.000	GTR 038	① ② ③ ④ ⑤ ⑦	■	100
A3363050036	PSR 050	ZK 36	51	30.000	GTR 038 and GTR 050	① ② ③ ④ ⑤ ⑦	■	100
A3363050060	PSR 050	ZK 60	51	30.000	GTR 038 and GTR 050	① ② ③ ④ ⑤ ⑦	■	100
A3363050080	PSR 050	ZK 80	51	30.000	GTR 038 and GTR 050	① ② ③ ④ ⑤ ⑦	■	100
A3363075036	PSR 075	ZK 36	76	20.000	GTR 075	① ② ③ ④ ⑤ ⑦	■	50
A3363075060	PSR 075	ZK 60	76	20.000	GTR 075	① ② ③ ④ ⑤ ⑦	■	50
A3363075080	PSR 075	ZK 80	76	20.000	GTR 075	① ② ③ ④ ⑤ ⑦	■	50

 Grinding, Polishing
(flexible)

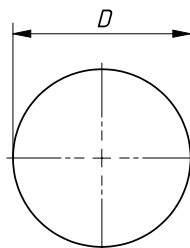
PSR, Abrasive Discs with plastic thread, quick-change heavy duty fleece

Ordering example: A3375038002

PG 8

Product number	Description	Quality/Grit	D mm	n max. (1/min)	Suitable carriers	recommended for Information on page 438		
A3375038005	PSR 038	Fleece fine	38	10.000	GTR 038	① ② ③ ④ ⑤ ⑥ ⑦ ⑧	■	50
A3375038002	PSR 038	Fleece medium	38	10.000	GTR 038	① ② ③ ④ ⑤ ⑥ ⑦ ⑧	■	50
A3375050004	PSR 050	Fleece coarse	51	8.000	GTR 038 and GTR 050	① ② ③ ④ ⑤ ⑥ ⑦ ⑧	■	50
A3375050005	PSR 050	Fleece fine	51	8.000	GTR 038 and GTR 050	① ② ③ ④ ⑤ ⑥ ⑦ ⑧	■	50
A3375050002	PSR 050	Fleece medium	51	8.000	GTR 038 and GTR 050	① ② ③ ④ ⑤ ⑥ ⑦ ⑧	■	50
A3375075004	PSR 075	Fleece coarse	76	5.500	GTR 038, GTR 050 and GTR 075	① ② ③ ④ ⑤ ⑥ ⑦ ⑧	■	25
A3375075005	PSR 075	Fleece fine	76	5.500	GTR 038, GTR 050 and GTR 075	① ② ③ ④ ⑤ ⑥ ⑦ ⑧	■	25
A3375075002	PSR 075	Fleece medium	76	5.500	GTR 038, GTR 050 and GTR 075	① ② ③ ④ ⑤ ⑥ ⑦ ⑧	■	25

SLTG, Flap Disc, quick-change type

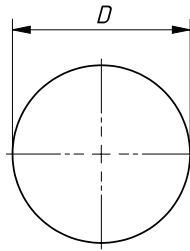

Ordering example: A33310500401623

v_{max.}: 50 m/s

ZK = Zirconia Alum. Oxide

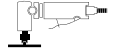

PG 8

Product number	Description	Grit	D mm	n max. (1/min)	Suitable carriers	recommended for	Information on page 438		
A33310500401623	SLTG 050 R	ZK 40	50	19.000	GTR 038.06	1 2 3 4 5 7		■	10
A33310500601623	SLTG 050 R	ZK 60	50	19.000	GTR 038.06	1 2 3 4 5 7		■	10
A33310500801623	SLTG 050 R	ZK 80	50	19.000	GTR 038.06	1 2 3 4 5 7		■	10
A33310501201623	SLTG 050 R	ZK 120	50	19.000	GTR 038.06	1 2 3 4 5 7		■	10
A33310650401623	SLTG 065 R	ZK 40	65	14.700	GTR 050.06	1 2 3 4 5 7		■	10
A33310650601623	SLTG 065 R	ZK 60	65	14.700	GTR 050.06	1 2 3 4 5 7		■	10
A33310650801623	SLTG 065 R	ZK 80	65	14.700	GTR 050.06	1 2 3 4 5 7		■	10
A33310750401623	SLTG 075 R	ZK 40	75	12.700	GTR 050.06	1 2 3 4 5 7		■	10
A33310750601623	SLTG 075 R	ZK 60	75	12.700	GTR 050.06	1 2 3 4 5 7		■	10
A33310750801623	SLTG 075 R	ZK 80	75	12.700	GTR 050.06	1 2 3 4 5 7		■	10
A33310751201623	SLTG 075 R	ZK 120	75	12.700	GTR 050.06	1 2 3 4 5 7		■	10

Properties:

- excellent cutting action
- aggressive, even with minimum grinding pressure
- long tool life (compared to fibre discs)
- lamellar projection
- flexible

Application:

- deburring
- fettling
- rust removal
- finishing
- cleaning of weld seams

Grinding, Polishing (flexible)

GTR, Mandrels for quick-change abrasive discs and SLTG with plastic thread

★★☆

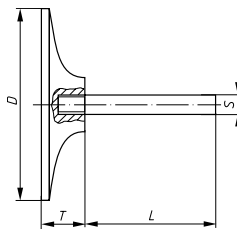

Ordering example: A33600380026

n_{max} : please also refer to Abrasive discs, PSR, page 319 and flap disc SLTG, page 320



PG 8

Product number	Description	D mm	S mm	Type	n max. (1/min)	recommended for	Information on page 438		
A33600380026	GTR 038.06	33	6	medium	25.000				■ 1
A33600500026	GTR 050.06	45	6	medium	25.000				■ 1
A33600750026	GTR 075.06	70	6	medium	20.000				■ 1

The mandrels are supplied with a hardness for universal application; our **medium** type is suitable for nearly all applications.

The stated maximum operating speed is calculated using the maximum mandrel diameter and maximum overhang L_0 of 5 mm. For other overhangs and smaller mandrel diameters, the maximum operating speed must be re-calculated.

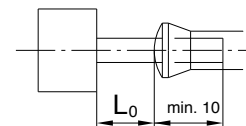

Grinding, Polishing (flexible)

PSK, Abrasive Discs, self-adhesive, Silicon carbide

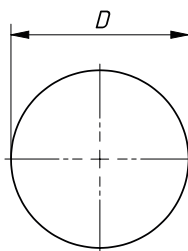

Ordering example: A2305018080

n_{max} : please refer to the mandrels self-adhesive GTK, page 323

SIC = Silicon carbide

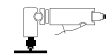

PG 8

Product number	Description	Grit	D mm	recommended for Information on page 438		
A2305018080	PSK 018	SIC 80	21	① ② ③ ④ ⑤ ⑥ ⑦ ⑧ ⑨	■	100
A2305018120	PSK 018	SIC 120	21	① ② ③ ④ ⑤ ⑥ ⑦ ⑧ ⑨	■	100
A2305030060	PSK 030	SIC 60	33	① ② ③ ④ ⑤ ⑥ ⑦ ⑧ ⑨	■	100
A2305030080	PSK 030	SIC 80	33	① ② ③ ④ ⑤ ⑥ ⑦ ⑧ ⑨	■	100
A2305030120	PSK 030	SIC 120	33	① ② ③ ④ ⑤ ⑥ ⑦ ⑧ ⑨	■	100
A2305045060	PSK 045	SIC 60	48	① ② ③ ④ ⑤ ⑥ ⑦ ⑧ ⑨	■	100
A2305045120	PSK 045	SIC 120	48	① ② ③ ④ ⑤ ⑥ ⑦ ⑧ ⑨	■	100

Grinding, Polishing
(flexible)

PSK, Abrasive Discs, self-adhesive, reg. Aluminium Oxide

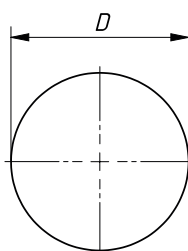

Ordering example: A2300018060

n_{max} : please refer to the mandrels self-adhesive GTK, page 323

NK = reg. Aluminium Oxide



PG 8

Product number	Description	Grit	D mm	recommended for Information on page 438		
A2300018060	PSK 018	NK 60	21	① ② ③ ④ ⑤ ⑥ ⑦ ⑧	■	100
A2300018080	PSK 018	NK 80	21	① ② ③ ④ ⑤ ⑥ ⑦ ⑧	■	100
A2300018120	PSK 018	NK 120	21	① ② ③ ④ ⑤ ⑥ ⑦ ⑧	■	100
A2300018150	PSK 018	NK 150	21	① ② ③ ④ ⑤ ⑥ ⑦ ⑧	■	100
A2300018180	PSK 018	NK 180	21	① ② ③ ④ ⑤ ⑥ ⑦ ⑧	■	100
A2300018240	PSK 018	NK 240	21	① ② ③ ④ ⑤ ⑥ ⑦ ⑧	■	100
A2300030060	PSK 030	NK 60	33	① ② ③ ④ ⑤ ⑥ ⑦ ⑧	■	100
A2300030080	PSK 030	NK 80	33	① ② ③ ④ ⑤ ⑥ ⑦ ⑧	■	100
A2300030120	PSK 030	NK 120	33	① ② ③ ④ ⑤ ⑥ ⑦ ⑧	■	100
A2300030150	PSK 030	NK 150	33	① ② ③ ④ ⑤ ⑥ ⑦ ⑧	■	100
A2300030180	PSK 030	NK 180	33	① ② ③ ④ ⑤ ⑥ ⑦ ⑧	■	100
A2300030240	PSK 030	NK 240	33	① ② ③ ④ ⑤ ⑥ ⑦ ⑧	■	100

PSK, Abrasive Discs, self-adhesive, reg. Aluminium Oxide

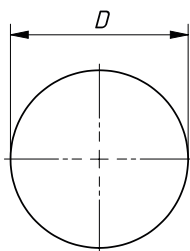

Ordering example: A2300018060

n_{max} : please refer to the mandrels self-adhesive GTK, page 323

NK = reg. Aluminium Oxide

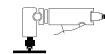

PG 8

Product number	Description	Grit	D mm	recommended for Information on page 438		
A2300045060	PSK 045	NK 60	48	① ② ③ ④ ⑤ ⑥ ⑦ ⑧	■	100
A2300045080	PSK 045	NK 80	48	① ② ③ ④ ⑤ ⑥ ⑦ ⑧	■	100
A2300045120	PSK 045	NK 120	48	① ② ③ ④ ⑤ ⑥ ⑦ ⑧	■	100
A2300045150	PSK 045	NK 150	48	① ② ③ ④ ⑤ ⑥ ⑦ ⑧	■	100
A2300045180	PSK 045	NK 180	48	① ② ③ ④ ⑤ ⑥ ⑦ ⑧	■	100
A2300045240	PSK 045	NK 240	48	① ② ③ ④ ⑤ ⑥ ⑦ ⑧	■	100
A2300060060	PSK 060	NK 60	63	① ② ③ ④ ⑤ ⑥ ⑦ ⑧	■	100
A2300060080	PSK 060	NK 80	63	① ② ③ ④ ⑤ ⑥ ⑦ ⑧	■	100
A2300060120	PSK 060	NK 120	63	① ② ③ ④ ⑤ ⑥ ⑦ ⑧	■	100
A2300060150	PSK 060	NK 150	63	① ② ③ ④ ⑤ ⑥ ⑦ ⑧	■	100
A2300075060	PSK 075	NK 60	78	① ② ③ ④ ⑤ ⑥ ⑦ ⑧	■	100
A2300075080	PSK 075	NK 80	78	① ② ③ ④ ⑤ ⑥ ⑦ ⑧	■	100
A2300075120	PSK 075	NK 120	78	① ② ③ ④ ⑤ ⑥ ⑦ ⑧	■	100
A2300075150	PSK 075	NK 150	78	① ② ③ ④ ⑤ ⑥ ⑦ ⑧	■	100

Grinding, Polishing (flexible)

GTK, Mandrels, for self-adhesive abrasive discs

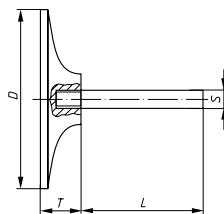

Ordering example: A250301830001

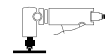

PG 8

Product number	Description	D mm	S mm	T mm	L mm	n max. (1/min)	recommended for Information on page 438		
A250301830001	GTK 018.03	18	3	11	30	20.000		■	5
A250303030001	GTK 030.03	30	3	12	30	12.500		■	5
A250303060001	GTK 030.06	30	6	12	40	12.500		■	5
A250304560001	GTK 045.06	45	6	11	40	10.000		■	5
A250306060001	GTK 060.06	60	6	13	40	8.000		■	5
A250307560001	GTK 075.06	75	6	15	40	6.000		■	2

The stated maximum operating speed only applies to a maximum overhang L_0 of 20 mm. Other overhang dimensions must be calculated separately.

PSH, Abrasive Discs, self-fixing

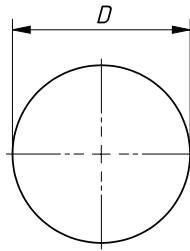
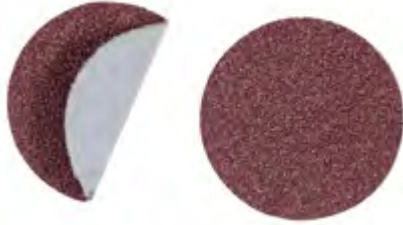

Ordering example: A3300018060

n_{max} : please refer to the mandrels self-fixing GTH, page 325
NK = reg. Aluminium Oxide

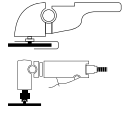

PG 8

Product number	Description	Grit	D mm	recommended for Information on page 438		
A3300018060	PSH 018	NK 60	20	① ② ③ ④ ⑤ ⑥ ⑦ ⑧	■	100
A3300018080	PSH 018	NK 80	20	① ② ③ ④ ⑤ ⑥ ⑦ ⑧	■	100
A3300018120	PSH 018	NK 120	20	① ② ③ ④ ⑤ ⑥ ⑦ ⑧	■	100
A3300018150	PSH 018	NK 150	20	① ② ③ ④ ⑤ ⑥ ⑦ ⑧	■	100
A3300018180	PSH 018	NK 180	20	① ② ③ ④ ⑤ ⑥ ⑦ ⑧	■	100
A3300018240	PSH 018	NK 240	20	① ② ③ ④ ⑤ ⑥ ⑦ ⑧	■	100
A3300018320	PSH 018	NK 320	20	① ② ③ ④ ⑤ ⑥ ⑦ ⑧	■	100
A3300030060	PSH 030	NK 60	33	① ② ③ ④ ⑤ ⑥ ⑦ ⑧	■	100
A3300030080	PSH 030	NK 80	33	① ② ③ ④ ⑤ ⑥ ⑦ ⑧	■	100
A3300030120	PSH 030	NK 120	33	① ② ③ ④ ⑤ ⑥ ⑦ ⑧	■	100
A3300030150	PSH 030	NK 150	33	① ② ③ ④ ⑤ ⑥ ⑦ ⑧	■	100
A3300030180	PSH 030	NK 180	33	① ② ③ ④ ⑤ ⑥ ⑦ ⑧	■	100
A3300030240	PSH 030	NK 240	33	① ② ③ ④ ⑤ ⑥ ⑦ ⑧	■	100
A3300030320	PSH 030	NK 320	33	① ② ③ ④ ⑤ ⑥ ⑦ ⑧	■	100
A3300045060	PSH 045	NK 60	48	① ② ③ ④ ⑤ ⑥ ⑦ ⑧	■	100
A3300045080	PSH 045	NK 80	48	① ② ③ ④ ⑤ ⑥ ⑦ ⑧	■	100
A3300045120	PSH 045	NK 120	48	① ② ③ ④ ⑤ ⑥ ⑦ ⑧	■	100
A3300045150	PSH 045	NK 150	48	① ② ③ ④ ⑤ ⑥ ⑦ ⑧	■	100
A3300045180	PSH 045	NK 180	48	① ② ③ ④ ⑤ ⑥ ⑦ ⑧	■	100
A3300045240	PSH 045	NK 240	48	① ② ③ ④ ⑤ ⑥ ⑦ ⑧	■	100
A3300060060	PSH 060	NK 60	63	① ② ③ ④ ⑤ ⑥ ⑦ ⑧	■	100
A3300060080	PSH 060	NK 80	63	① ② ③ ④ ⑤ ⑥ ⑦ ⑧	■	100
A3300060120	PSH 060	NK 120	63	① ② ③ ④ ⑤ ⑥ ⑦ ⑧	■	100
A3300060150	PSH 060	NK 150	63	① ② ③ ④ ⑤ ⑥ ⑦ ⑧	■	100
A3300060180	PSH 060	NK 180	63	① ② ③ ④ ⑤ ⑥ ⑦ ⑧	■	100
A3300060240	PSH 060	NK 240	63	① ② ③ ④ ⑤ ⑥ ⑦ ⑧	■	100
A3300060320	PSH 060	NK 320	63	① ② ③ ④ ⑤ ⑥ ⑦ ⑧	■	100
A3300075060	PSH 075	NK 60	78	① ② ③ ④ ⑤ ⑥ ⑦ ⑧	■	100
A3300075080	PSH 075	NK 80	78	① ② ③ ④ ⑤ ⑥ ⑦ ⑧	■	100
A3300075120	PSH 075	NK 120	78	① ② ③ ④ ⑤ ⑥ ⑦ ⑧	■	100
A3300075150	PSH 075	NK 150	78	① ② ③ ④ ⑤ ⑥ ⑦ ⑧	■	100
A3300075180	PSH 075	NK 180	78	① ② ③ ④ ⑤ ⑥ ⑦ ⑧	■	100
A3300075240	PSH 075	NK 240	78	① ② ③ ④ ⑤ ⑥ ⑦ ⑧	■	100
A3300075320	PSH 075	NK 320	78	① ② ③ ④ ⑤ ⑥ ⑦ ⑧	■	100
A3300120060	PSH 125	NK 60	125	① ② ③ ④ ⑤ ⑥ ⑦ ⑧	■	100
A3300120080	PSH 125	NK 80	125	① ② ③ ④ ⑤ ⑥ ⑦ ⑧	■	100

Grinding, Polishing
(flexible)

GTH, Mandrels, for self-fixing abrasive discs

★★☆

Ordering example: A250401830001

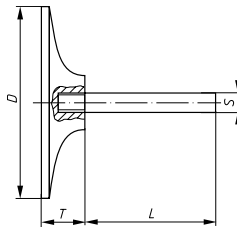

PG 8

Product number	Description	D mm	S mm	T mm	L mm	n max. (1/min)	recommended for Information on page 438		
A250401830001	GTH 018.03	18	3	11	30	20.000		■	5
A250403030001	GTH 030.03	30	3	12	30	12.500		■	5
A250403060001	GTH 030.06	30	6	12	40	12.500		■	5
A250404560001	GTH 045.06	45	6	11	40	10.000		■	5
A250406060001	GTH 060.06	60	6	13	40	8.000		■	5
A250407560001	GTH 075.06	75	6	15	40	6.000		■	2
A25041206	GTH 120.06	120	6	20	25	4.000		■	2

The stated maximum operating speed only applies to a maximum overhang L_0 of 20 mm. Other overhang dimensions must be calculated separately.

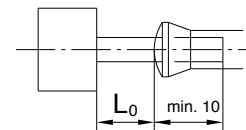

Grinding, Polishing (flexible)

**PSH, Quick-change abrasive discs with non-woven material,
Velcro self fixing system**



Ordering example: A3380115102

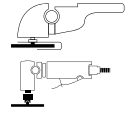

PG 8

Product number	Description	Quality	D mm	n recom. (1/min)	n max. (1/min)	recommended for Information on page 438		
A3380115102	PSH 115	Fleece coarse	115	4.000	8.000	① ② ③ ④ ⑤ ⑥ ⑦ ⑧	■	10
A3380115104	PSH 115	Fleece medium	115	4.000	8.000	① ② ③ ④ ⑤ ⑥ ⑦ ⑧	■	10
A3380115107	PSH 115	Fleece fine	115	4.000	8.000	① ② ③ ④ ⑤ ⑥ ⑦ ⑧	■	10
A3380125102	PSH 125	Fleece coarse	125	3.800	7.650	① ② ③ ④ ⑤ ⑥ ⑦ ⑧	■	10
A3380125104	PSH 125	Fleece medium	125	3.800	7.650	① ② ③ ④ ⑤ ⑥ ⑦ ⑧	■	10
A3380125107	PSH 125	Fleece fine	125	4.800	7.650	① ② ③ ④ ⑤ ⑥ ⑦ ⑧	■	10

Grinding, Polishing
(flexible)

GTH, Mandrels for abrasive discs with non-woven material

★★☆

Ordering example: A38311151003

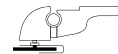
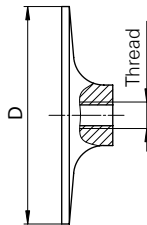

PG 8

Product number	Description	D mm	Thread	n max. (1/min)	recommended for Information on page 438		
A38311151003	GTH 115	115	M14	8.000		■	1
A38311251003	GTH 125	125	M14	7.650		■	1

Grinding, Polishing (flexible)

Fibre discs, backing plates, economy rolls, abrasive sheets and fleece rolls

196 Qualities and Applications

330 General Information

331 FIS, Fibre Discs with slotted hole

335 Semi-flexible grinding disc

336 STF, Fibre Disc Backing Pad

337 Economy rolls

338 SLB, sheets of abrasive cloth

339 Fleece pads

339 Fleece rolls

Product line marking

The product lines are illustrated by star symbols at the top of the table; please refer to page **14** and **15**.

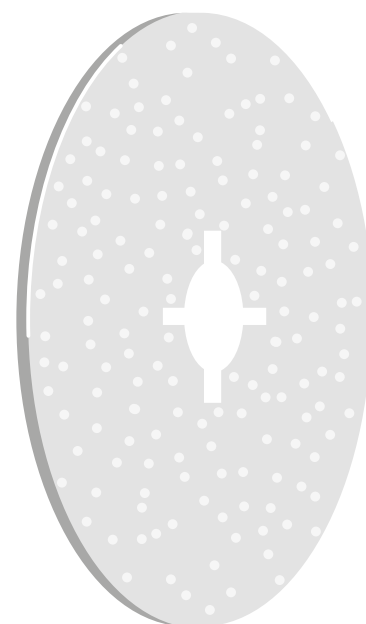

Grinding, Polishing
(flexible)

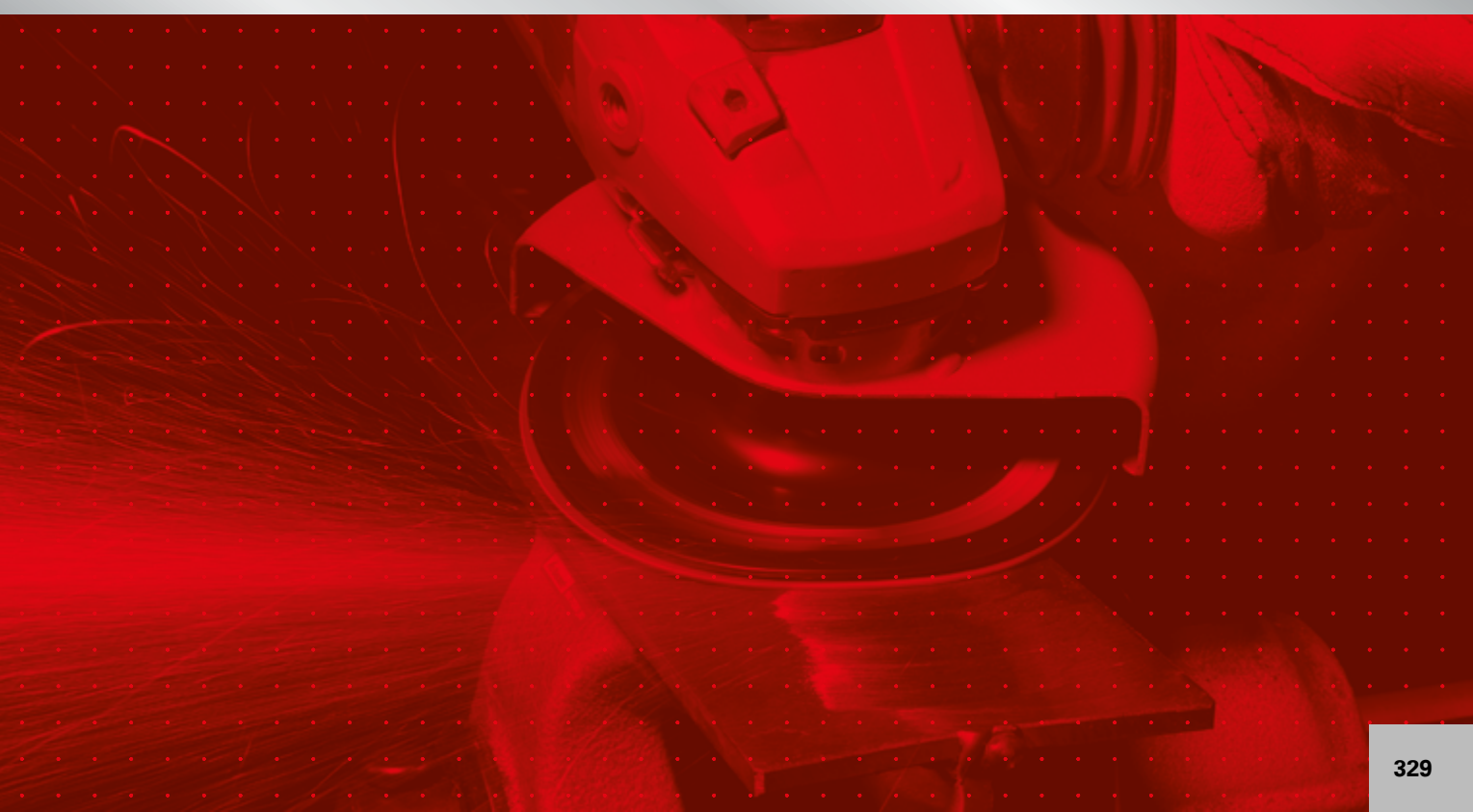

Informationen

FIS, Fibre Discs

Fibre-backed discs FIS are used on angle grinders with a backing pad STF. We offer this very popular product in NK, ZK and Ceramic for universal application.

SHF semi-flexible grinding disc

The SHF semi-flexible grinding disc consists of a stable fibre backing with a structured abrasive coating of silicon carbide. This combination is particularly suitable for coarse grinding work on the biggest variety of materials. Typical applications are the removal of paint, rust and adhesives, but also the processing of glass-fibre reinforced plastics such as GRP and CRP (e.g. during the manufacture of wind turbine blades). Like fibre discs, semi-flexible grinding discs for angle grinders are only used with an STF backing plate.

SPR, Economy rolls

We supply economy rolls manufactured from flexible coated abrasive for off-hand application. The appropriate length can be cut from the roll.

SVB, Fleece pads and SVR, Fleece rolls

We supply abrasive fleece economy rolls and pads used off-hand or on vibratory finishing machines. These can be used wet or dry.

FIS, Fibre Disc with slotted hole, Ceramic grain

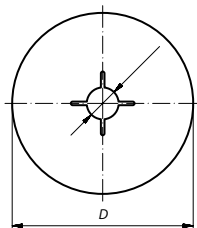
★★★

Ordering example: A38301150243

 $v_{max.}: 80 \text{ m/s}$

ISO 16057

Ceramic = ceramic grain

PG 10

Product number	Description	Grit	D mm	Bore mm	n max. (1/min)	recommended for							Information on page 438	PG 10	
						1	2	3	4	5	6	7			
A383011502030001	FIS 115	Ceramic 20	115	22	13.300	1	2	3	4	5	6	7		■	50
A383011503630001	FIS 115	Ceramic 36	115	22	13.300	1	2	3	4	5	6	7		■	50
A383011504030001	FIS 115	Ceramic 40	115	22	13.300	1	2	3	4	5	6	7		■	50
A383011505030001	FIS 115	Ceramic 50	115	22	13.300	1	2	3	4	5	6	7		■	50
A383011506030001	FIS 115	Ceramic 60	115	22	13.300	1	2	3	4	5	6	7		■	50
A383011508030001	FIS 115	Ceramic 80	115	22	13.300	1	2	3	4	5	6	7		■	50
A383012502030001	FIS 125	Ceramic 20	125	22	12.200	1	2	3	4	5	6	7		■	50
A383012502430001	FIS 125	Ceramic 24	125	22	12.200	1	2	3	4	5	6	7		■	50
A383012503630001	FIS 125	Ceramic 36	125	22	12.200	1	2	3	4	5	6	7		■	50
A383012504030001	FIS 125	Ceramic 40	125	22	12.200	1	2	3	4	5	6	7		■	50
A383012506030001	FIS 125	Ceramic 60	125	22	12.200	1	2	3	4	5	6	7		■	50
A383012508030001	FIS 125	Ceramic 80	125	22	12.200	1	2	3	4	5	6	7		■	50
A383012512030001	FIS 125	Ceramic 120	125	22	12.200	1	2	3	4	5	6	7		■	150
A383015002030001	FIS 150	Ceramic 20	150	22	10.200	1	2	3	4	5	6	7		■	50
A383015003630001	FIS 150	Ceramic 36	150	22	10.200	1	2	3	4	5	6	7		■	50
A383015004030001	FIS 150	Ceramic 40	150	22	10.200	1	2	3	4	5	6	7		■	50
A383018002030001	FIS 180	Ceramic 20	180	22	8.500	1	2	3	4	5	6	7		■	50
A383018003630001	FIS 180	Ceramic 36	180	22	8.500	1	2	3	4	5	6	7		■	50
A383018004030001	FIS 180	Ceramic 40	180	22	8.500	1	2	3	4	5	6	7		■	50
A383018006030001	FIS 180	Ceramic 60	180	22	8.500	1	2	3	4	5	6	7		■	50
A383018008030001	FIS 180	Ceramic 80	180	22	8.500	1	2	3	4	5	6	7		■	50

Grinding, Polishing (flexible)

FIS, Fibre Disc with slotted hole, Zirconia Alum. Oxide

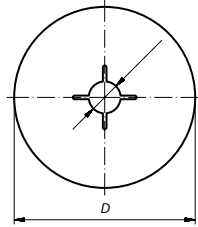

Ordering example: A38301150242

v_{max.}: 80 m/s

ISO 16057

ZK = Zirconia Alum. Oxide

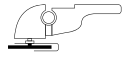

PG 3

Product number	Description	Grit	D mm	Bore mm	n max. (1/min)	recommended for								PG 3	50	
						Information on page 438										
A38301150242	FIS 115	ZK 24	115	22	13.300	2	3	4	5	7						
A38301150362	FIS 115	ZK 36	115	22	13.300	2	3	4	5	7						
A38301150402	FIS 115	ZK 40	115	22	13.300	2	3	4	5	7						
A38301150602	FIS 115	ZK 60	115	22	13.300	2	3	4	5	7						
A38301150802	FIS 115	ZK 80	115	22	13.300	2	3	4	5	7						
A38301250242	FIS 125	ZK 24	125	22	12.200	2	3	4	5	7						
A38301250362	FIS 125	ZK 36	125	22	12.200	2	3	4	5	7						
A38301250402	FIS 125	ZK 40	125	22	12.200	2	3	4	5	7						
A38301250602	FIS 125	ZK 60	125	22	12.200	2	3	4	5	7						
A38301250802	FIS 125	ZK 80	125	22	12.200	2	3	4	5	7						

Grinding, Polishing (flexible)

FIS, Fibre Disc with slotted hole, reg. Aluminium Oxide

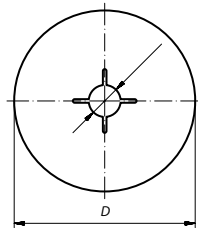

Ordering example: A38301150241

v_{max.}: 80 m/s

ISO 16057

NK = reg. Aluminium Oxide



PG 3

Product number	Description	Grit	D mm	Bore mm	n max. (1/min)	recommended for								PG 3	50	
						Information on page 438										
A38301150241	FIS 115	NK 24	115	22	13.300	1	2	3	4	5	6	7	8			
A38301150361	FIS 115	NK 36	115	22	13.300	1	2	3	4	5	6	7	8			
A38301150401	FIS 115	NK 40	115	22	13.300	1	2	3	4	5	6	7	8			
A38301150501	FIS 115	NK 50	115	22	13.300	1	2	3	4	5	6	7	8			
A38301150601	FIS 115	NK 60	115	22	13.300	1	2	3	4	5	6	7	8			
A38301150801	FIS 115	NK 80	115	22	13.300	1	2	3	4	5	6	7	8			
A38301151201	FIS 115	NK 120	115	22	13.300	1	2	3	4	5	6	7	8			
A38301250241	FIS 125	NK 24	125	22	12.200	1	2	3	4	5	6	7	8			
A38301250361	FIS 125	NK 36	125	22	12.200	1	2	3	4	5	6	7	8			
A38301250401	FIS 125	NK 40	125	22	12.200	1	2	3	4	5	6	7	8			

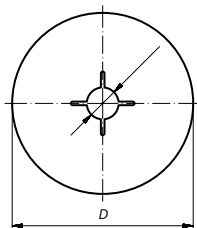
FIS, Fibre Disc with slotted hole, reg. Aluminium Oxide

Ordering example: A38301150241

 $v_{max.}: 80 \text{ m/s}$

ISO 16057

NK = reg. Aluminium Oxide

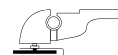
PG 3

Product number	Description	Grit	D mm	Bore mm	n max. (1/min)	recommended for Information on page 438		
A38301250501	FIS 125	NK 50	125	22	12.200	① ② ③ ④ ⑤ ⑥ ⑦ ⑧	■	50
A38301250601	FIS 125	NK 60	125	22	12.200	① ② ③ ④ ⑤ ⑥ ⑦ ⑧	■	50
A38301250801	FIS 125	NK 80	125	22	12.200	① ② ③ ④ ⑤ ⑥ ⑦ ⑧	■	50
A38301500401	FIS 150	NK 40	150	22	10.200	① ② ③ ④ ⑤ ⑥ ⑦ ⑧	■	50
A38301500601	FIS 150	NK 60	150	22	10.200	① ② ③ ④ ⑤ ⑥ ⑦ ⑧	■	50
A38301800161	FIS 180	NK 16	180	22	8.500	① ② ③ ④ ⑤ ⑥ ⑦ ⑧	■	25
A38301800241	FIS 180	NK 24	180	22	8.500	① ② ③ ④ ⑤ ⑥ ⑦ ⑧	■	50
A38301800361	FIS 180	NK 36	180	22	8.500	① ② ③ ④ ⑤ ⑥ ⑦ ⑧	■	50
A38301800401	FIS 180	NK 40	180	22	8.500	① ② ③ ④ ⑤ ⑥ ⑦ ⑧	■	50
A38301800601	FIS 180	NK 60	180	22	8.500	① ② ③ ④ ⑤ ⑥ ⑦ ⑧	■	50
A38301800801	FIS 180	NK 80	180	22	8.500	① ② ③ ④ ⑤ ⑥ ⑦ ⑧	■	50

 Grinding, Polishing
(flexible)

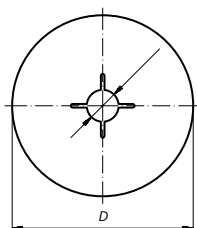
FIS BASE-X, Fibre Disc with slotted hole, reg. Aluminium Oxide

Ordering example: A7830115024101

 $v_{max.}: 80 \text{ m/s}$

ISO 16057

NK = reg. Aluminium Oxide

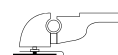
PG 10

Product number	Description	Grit	D mm	Bore mm	n max. (1/min)	recommended for Information on page 438		
A7830115024101	FIS 115	NK 24	115	22	13.300	① ② ③ ④ ⑤ ⑥ ⑦ ⑧	■	25
A7830115036101	FIS 115	NK 36	115	22	13.300	① ② ③ ④ ⑤ ⑥ ⑦ ⑧	■	25
A7830115040101	FIS 115	NK 40	115	22	13.300	① ② ③ ④ ⑤ ⑥ ⑦ ⑧	■	25
A7830115060101	FIS 115	NK 60	115	22	13.300	① ② ③ ④ ⑤ ⑥ ⑦ ⑧	■	25
A7830115080101	FIS 115	NK 80	115	22	13.300	① ② ③ ④ ⑤ ⑥ ⑦ ⑧	■	25
A7830125024101	FIS 125	NK 24	125	22	12.200	① ② ③ ④ ⑤ ⑥ ⑦ ⑧	■	25
A7830125036101	FIS 125	NK 36	125	22	12.200	① ② ③ ④ ⑤ ⑥ ⑦ ⑧	■	25
A7830125040101	FIS 125	NK 40	125	22	12.200	① ② ③ ④ ⑤ ⑥ ⑦ ⑧	■	25
A7830125060101	FIS 125	NK 60	125	22	12.200	① ② ③ ④ ⑤ ⑥ ⑦ ⑧	■	25

FIS BASE-X, Fibre Disc with slotted hole, reg. Aluminium Oxide

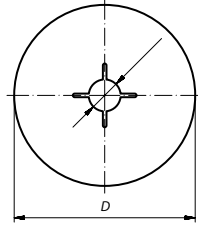

Ordering example: A7830115024101

$v_{max.}$: 80 m/s

ISO 16057

NK = reg. Aluminium Oxide

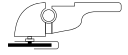

PG 10

Product number	Description	Grit	D mm	Bore mm	n max. (1/min)	recommended for Information on page 438		
A7830125080101	FIS 125	NK 80	125	22	12.200	① ② ③ ④ ⑤ ⑥ ⑦ ⑧	■	25
A7830125120101	FIS 125	NK 120	125	22	12.200	① ② ③ ④ ⑤ ⑥ ⑦ ⑧	■	25
A7830180024101	FIS 180	NK 24	180	22	8.500	① ② ③ ④ ⑤ ⑥ ⑦ ⑧	■	25
A7830180036101	FIS 180	NK 36	180	22	8.500	① ② ③ ④ ⑤ ⑥ ⑦ ⑧	■	25
A7830180040101	FIS 180	NK 40	180	22	8.500	① ② ③ ④ ⑤ ⑥ ⑦ ⑧	■	25
A7830180060101	FIS 180	NK 60	180	22	8.500	① ② ③ ④ ⑤ ⑥ ⑦ ⑧	■	25
A7830180080101	FIS 180	NK 80	180	22	8.500	① ② ③ ④ ⑤ ⑥ ⑦ ⑧	■	25

Grinding, Polishing
(flexible)

SHF, semi-flexible grinding disc

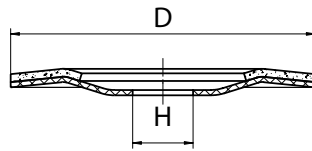

Ordering example: A38351150164

C = Silicon carbide

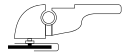

PG 10

Product number	Description	Grit	D mm	H mm	n max. (1/min)	recommended for Information on page 438													
A38351150164	SHF 115	C16	115	22,23	13.300	1 2 5 6 8 10												■	25
A38351150244	SHF 115	C24	115	22,23	13.300	1 2 5 6 8 10												■	25
A38351150364	SHF 115	C36	115	22,23	13.300	1 2 5 6 8 10												■	25
A38351150604	SHF 115	C60	115	22,23	13.300	1 2 5 6 8 10												■	25
A38351250244	SHF 125	C24	125	22,23	12.200	1 2 5 6 8 10												■	25
A38351250364	SHF 125	C36	125	22,23	12.200	1 2 5 6 8 10												■	25

Use only with backing plate.

Grinding, Polishing (flexible)

STF HL, Backing-Pad with cooling ribs for Fibre Discs

★★★

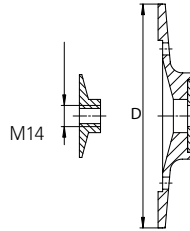

Ordering example: A38311151002

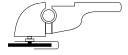

PG 10

Product number	Description	D mm	Thread	n max. (1/min)	recommended for Information on page 438		
A38311151002	STF HL	113	M 14	13.300		■	1
A38311251002	STF HL	123	M 14	12.200		■	1
A38311501002	STF HL	148	M 14	10.200		■	1
A38311801002	STF HL	175	M 14	8.500		■	1

The mandrels are supplied in a hardness for universal tasks, and our medium design is suitable for practically every application. Our designs for radii and rough grinding work can be delivered on request. Cooling ribs and ventilation holes increase the stock removal rate and service life of mounted tools.

Grinding, Polishing (flexible)

STF, Fibre Disc Backing-Pad with threaded flange

★★☆

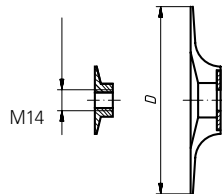

Ordering example: A38311151001

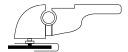

PG 10

Product number	Description	D mm	Thread	n max. (1/min)	recommended for Information on page 438		
A38311151001	STF 115	113	M 14	13.300		■	1
A38311251001	STF 125	123	M 14	12.200		■	1
A38311501001	STF 150	148	M 14	10.200		■	1
A38311701001	STF 180	175	M 14	8.500		■	1

The Backing-Pads are supplied with different hardnesses for universal application; the medium hardness is suitable for nearly all applications. Other hardnesses are available for snagging and profiling operations.

SPR, Economy Rolls, reg. Aluminium Oxide



Ordering example: A3821025040
NK = reg. Aluminium Oxide



PG 8

Product number	Description	Grit	Thickness mm	Length m	recommended for Information on page 438		
A3821025040	SPR 025	NK 40	25	50	① ② ③ ④ ⑤ ⑥ ⑦ ⑧	■	1
A3821025060	SPR 025	NK 60	25	50	① ② ③ ④ ⑤ ⑥ ⑦ ⑧	■	1
A3821025080	SPR 025	NK 80	25	50	① ② ③ ④ ⑤ ⑥ ⑦ ⑧	■	1
A3821025100	SPR 025	NK 100	25	50	① ② ③ ④ ⑤ ⑥ ⑦ ⑧	■	1
A3821025120	SPR 025	NK 120	25	50	① ② ③ ④ ⑤ ⑥ ⑦ ⑧	■	1
A3821025150	SPR 025	NK 150	25	50	① ② ③ ④ ⑤ ⑥ ⑦ ⑧	■	1
A3821025180	SPR 025	NK 180	25	50	① ② ③ ④ ⑤ ⑥ ⑦ ⑧	■	1
A3821025240	SPR 025	NK 240	25	50	① ② ③ ④ ⑤ ⑥ ⑦ ⑧	■	1
A3821025320	SPR 025	NK 320	25	50	① ② ③ ④ ⑤ ⑥ ⑦ ⑧	■	1
A3821025400	SPR 025	NK 400	25	50	① ② ③ ④ ⑤ ⑥ ⑦ ⑧	■	1
A3821040040	SPR 040	NK 40	40	50	① ② ③ ④ ⑤ ⑥ ⑦ ⑧	■	1
A3821040060	SPR 040	NK 60	40	50	① ② ③ ④ ⑤ ⑥ ⑦ ⑧	■	1
A3821040080	SPR 040	NK 80	40	50	① ② ③ ④ ⑤ ⑥ ⑦ ⑧	■	1
A3821040100	SPR 040	NK 100	40	50	① ② ③ ④ ⑤ ⑥ ⑦ ⑧	■	1
A3821040120	SPR 040	NK 120	40	50	① ② ③ ④ ⑤ ⑥ ⑦ ⑧	■	1
A3821040150	SPR 040	NK 150	40	50	① ② ③ ④ ⑤ ⑥ ⑦ ⑧	■	1
A3821040180	SPR 040	NK 180	40	50	① ② ③ ④ ⑤ ⑥ ⑦ ⑧	■	1
A3821040240	SPR 040	NK 240	40	50	① ② ③ ④ ⑤ ⑥ ⑦ ⑧	■	1
A3821040320	SPR 040	NK 320	40	50	① ② ③ ④ ⑤ ⑥ ⑦ ⑧	■	1
A3821040400	SPR 040	NK 400	40	50	① ② ③ ④ ⑤ ⑥ ⑦ ⑧	■	1

Grinding, Polishing
(flexible)

LUKAS Economy Rolls with their great grinding characteristics help to manage your manual grinding at optimum level.

SLB, Sheets of abrasive cloth



Ordering example: A3825230280040

NK = reg. Aluminium Oxide

PG 8

Product number	Description	Quality	Thickness mm	Length mm	recommended for Information on page 438		
A3825230280040	SLB 230280	NK 40	230	280	① ② ③ ④ ⑤ ⑥ ⑦ ⑧	■	50
A3825230280060	SLB 230280	NK 60	230	280	① ② ③ ④ ⑤ ⑥ ⑦ ⑧	■	50
A3825230280080	SLB 230280	NK 80	230	280	① ② ③ ④ ⑤ ⑥ ⑦ ⑧	■	50
A3825230280100	SLB 230280	NK 100	230	280	① ② ③ ④ ⑤ ⑥ ⑦ ⑧	■	50
A3825230280120	SLB 230280	NK 120	230	280	① ② ③ ④ ⑤ ⑥ ⑦ ⑧	■	50
A3825230280150	SLB 230280	NK 150	230	280	① ② ③ ④ ⑤ ⑥ ⑦ ⑧	■	50
A3825230280180	SLB 230280	NK 180	230	280	① ② ③ ④ ⑤ ⑥ ⑦ ⑧	■	50
A3825230280220	SLB 230280	NK 220	230	280	① ② ③ ④ ⑤ ⑥ ⑦ ⑧	■	50
A3825230280240	SLB 230280	NK 240	230	280	① ② ③ ④ ⑤ ⑥ ⑦ ⑧	■	50
A3825230280320	SLB 230280	NK 320	230	280	① ② ③ ④ ⑤ ⑥ ⑦ ⑧	■	50
A3825230280400	SLB 230280	NK 400	230	280	① ② ③ ④ ⑤ ⑥ ⑦ ⑧	■	50
A3825230280999	SLB 230280	NK 999	230	280	① ② ③ ④ ⑤ ⑥ ⑦ ⑧	■	50

The LUKAS-sheets of abrasive cloth with optimum abrasive properties will enable you to achieve outstanding results with your manual grinding applications.

Grinding, Polishing
(flexible)

SVB, Fleece Pads



Ordering example: A380115023011

A = reg. Aluminium Oxide

C = Silicon carbide

PG 8

Product number	Description	Quality	Type	Thickness mm	Length mm	recommended for Information on page 438		
A380115023011	SVB 150230	A Medium	red-brown	150	230	① ② ③ ④ ⑤ ⑥ ⑦ ⑧	■	10
A380115023012	SVB 150230	A Fine	green	150	230	① ② ③ ④ ⑤ ⑥ ⑦ ⑧	■	10
A380115023013	SVB 150230	A Very Fine	red-brown	150	230	① ② ③ ④ ⑤ ⑥ ⑦ ⑧	■	10
A380115023024	SVB 150230	C Ultra Fine	grey	150	230	① ② ③ ④ ⑤ ⑥ ⑦ ⑧ ⑨	■	10

LUKAS-fleece pads are used to remove corrosion and stain from metal surfaces as well as to clean and polish surfaces of any kind of material.

Grinding, Polishing
(flexible)

SVR, Fleece Rolls



Ordering example: A382011501012

A = reg. Aluminium Oxide

C = Silicon carbide

PG 8

Product number	Description	Quality	Type	Thickness mm	Length m	recommended for Information on page 438		
A382011501012	SVR 115	A Fine	green	115	10	① ② ③ ④ ⑤ ⑥ ⑦ ⑧	■	1
A382011501013	SVR 115	A Very Fine	red-brown	115	10	① ② ③ ④ ⑤ ⑥ ⑦ ⑧	■	1
A382011501024	SVR 115	C Ultra Fine	grey	115	10	① ② ③ ④ ⑤ ⑥ ⑦ ⑧ ⑨	■	1

LUKAS-fleece rolls are used to remove corrosion and stain from metal surfaces as well as to clean and polish surfaces of any kind of material.

Diamondtools

342 Technical Information

343 Qualities and application

344 Diamond cutting discs

350 Diamond cup wheels

351 Diamond dry drill

352 Drill bit for socket outlets

Product line marking

The product lines are illustrated by star symbols at the top of the table; please refer to page **14** and **15**.

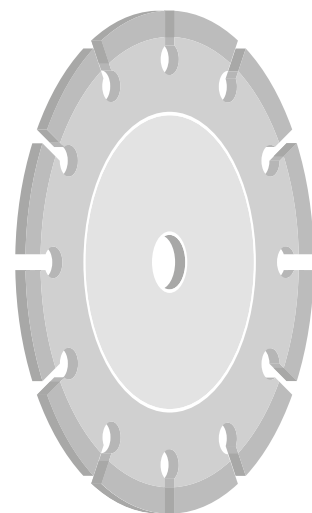

Cutting, Rough Grinding
(diamond)

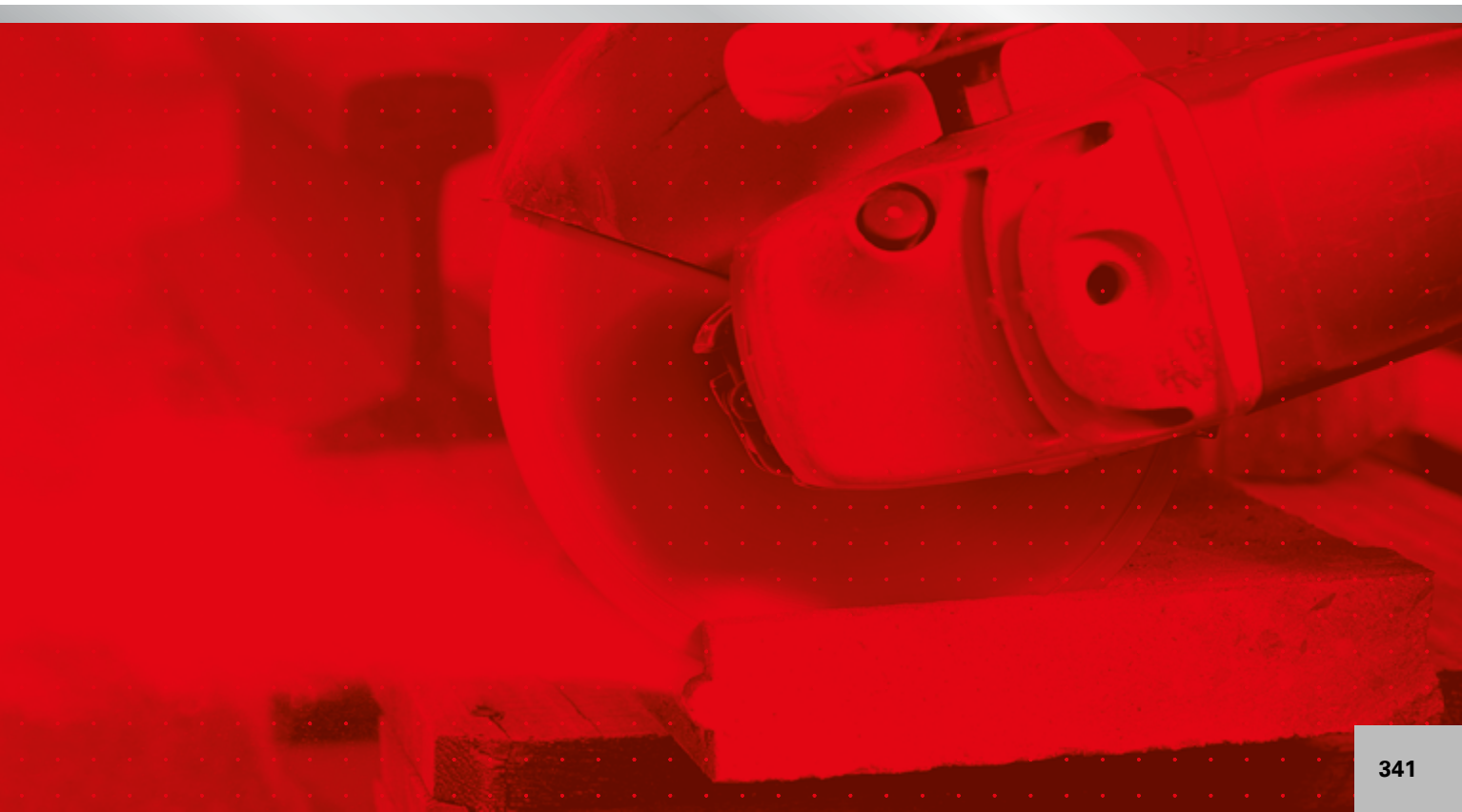

Technical Information

The Diamond

Diamonds are the hardest known material. They are selected depending on the field of application. For diamond blade manufacture synthetic diamonds are solely used. Compared to natural diamonds, their properties are reproducible and controllable.

The following quality characteristics are significant for selecting diamonds:

- degree of purity
- defined breaking strength
- sharp edges
- consistent geometry

Diamonds are classified by quality levels and grain sizes.

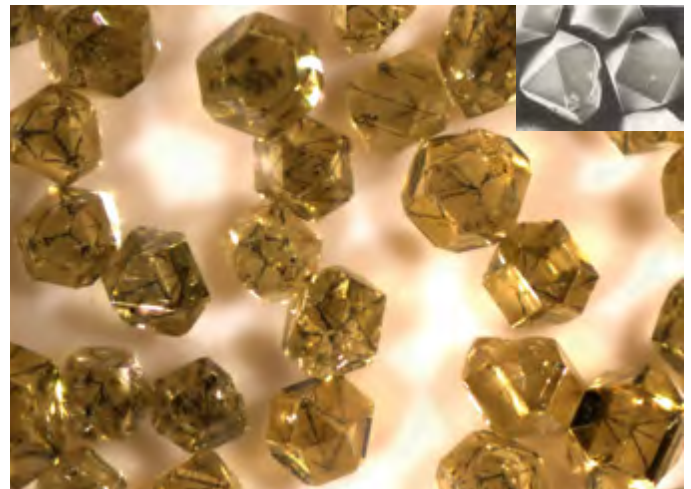

The Segment

The segments consist of diamond embedded metal powder. The metal bond must be suited to the material to be cut. The metal powder consists, for example, of bronze, cobalt, iron, metal carbides, tungsten carbide. The various properties of metal powder provide for sharpness and wear and tear of the segment. Segment coating is carried out by sintering. Therefore, abrasive materials require a hard bond against what hard materials call for soft bond.

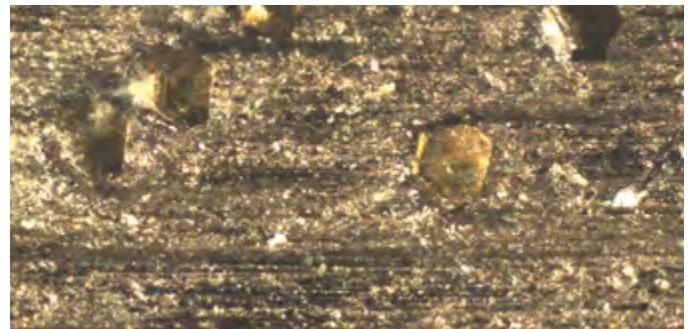

Due to the patented forged segment geometry even high segments can be arranged with small gaps in between. This produces considerably lower vibration for the user. Another essential advantage is safety. The dense segments have been forged without any pores. This ensures welding properties which provide much more safety against fracture compared to the usual sintered segments.

- Universal and fast – owing to new types of alloys in the segments
- Less vibration – owing to a trapezoid segment geometry
- More safety – owing to segment feet which are free of pores and provide for the utmost safety
- Longer life – owing to higher segments and retarded diamond shedding

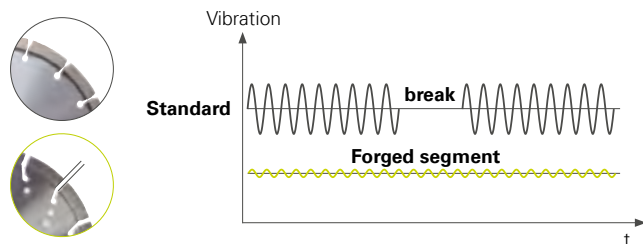

Comparison of cutting properties low vibration cutting discs with narrow gaps

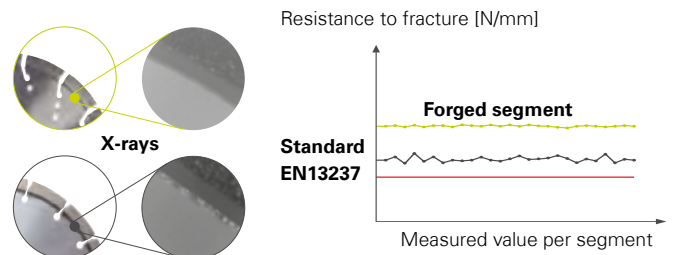

Welding properties of forged segment: with highest safety against fracture

Cutting, Rough Grinding (diamond)

User Instructions

Fine stoneware		Catalogue page	Tiles			Granite, hard materials			Concrete			Building material				Asphalt, abrasive materials				Segment height	
■ best suitable ■ suitable			Tiles	Fine stoneware	Granite tiles	Granite	Porphyry	Clinker bricks	Reinforced concrete	Exposed aggregate concrete	Concrete products	Bricks, masonry	Roof tiles	Gas concrete, pumice	Sand-lime brick	Refractory bricks	Screed	Fresh concrete	Asphalt		Grey iron
Diamond cutting discs																					
★★★	VDC	344	■	■	■			■	■	■	■	■	■	■						■	7
	Universal S13	344						■	■	■	■	■	■	■	■	■	■	■	■	■	13
	LD MULTI S13	345					■	■	■	■	■	■	■	■							13
★★☆	LD3 S10	346				■	■		■	■	■	■	■	■							10
	LD7 S10	346														■			■		10
	TURBO S10	347						■	■	■	■	■	■	■							10
★☆☆	BLUE CUT S10	347							■	■	■	■	■	■							10
	TC7	348								■	■	■	■	■							7
Tile cutting discs																					
★★★	FAST CUT S7/S10	348	■	■	■		■	■													7/10
★★☆	FLIESE S7	349	■	■	■																7
★☆☆	FC7	349	■																		7
Diamond cup wheels																					
★★★	DST SP S5	350				■	■	■	■	■	■	■	■	■	■	■	■	■	■	■	5
★★☆	DST S6	350						■	■	■	■	■	■	■	■	■	■	■	■	■	6
★☆☆	DST S5	351								■	■	■	■	■							5
Diamond dry drill																					
★☆☆	DTB	351	■	■	■	■															15
Drill bit for socket outlets																					
★☆☆	DSK	352									■	■	■	■							8

Cutting, Rough Grinding (diamond)

★★★ High Performance

- extremely quick cut, even through difficult materials
- Very good service life and designed for universal applications, for professional use

★★☆ Industry

- quick cut and reliable
- long service life

★☆☆ Base

- price-conscious and good

VDC, a revolution in the cutting of grey cast iron

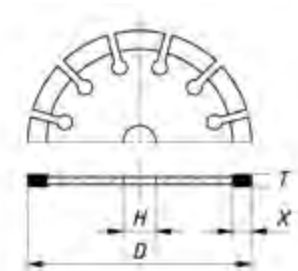

Ordering example: A34901152222

v_{max.}: 80 m/s

iQ Series

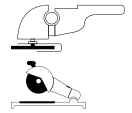

PG 7

Product number	Description	D mm	Height of segments X mm	Width of segments T mm	H mm	n max. (1/min)	Recommended for Information on page 438		
A34901152222	VDC 115022	115	7,0	2,2	22,23	13.300	5 8 10 11 12	■	1
A34901252222	VDC 125022	125	7,0	2,2	22,23	12.200	5 8 10 11 12	■	1
A34901802622	VDC 180026	180	7,0	2,2	22,23	8.500	5 8 10 11 12	■	1
A34902303022	VDC 230030	230	7,0	3,0	22,23	6.600	5 8 10 11 12	■	1
A34903503632	VDC 350036	350	7,0	3,6	32,00	4.400	5 8 10 11 12	■	1

Special properties:

- Low temperaturesw
- No dust and build-up of odours
- No expiry date
- No reduction in diameter
- vacuum-brazed
- very aggressive
- extreme tool life

Ideal for cutting of

- Grey cast iron (GG, GGG)
- Glass-fibre reinforced plastic (GFK)
- burning-in

Not suitable for high-alloyed nickel-containing materials

Please refer to the chart on page 343 for detailed information on applications.

Cutting, Rough Grinding (diamond)

Universal S13, for roadbuilding and construction sites

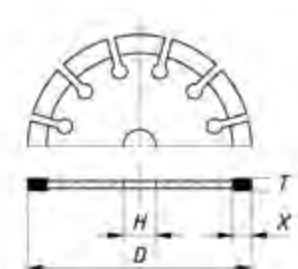

Ordering example: A3440072301213153

v_{max.}: 100 m/s

Ø 230 mm: 80 m/s

Ø 450 mm: 63 m/s

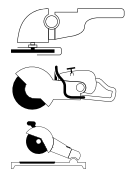

PG 7

Product number	Description	D mm	Height of segments X mm	Width of segments T mm	H mm	n max. (1/min)	Recommended for Information on page 438		
A3440072301213153	Universal S13	230	13	2,6	22,23	6.600	10 11 15 16	■	1
A7440073003213183	Universal S13	300	13	2,8	20	6.400	10 11 15 16	▲	1
A3440073002213183	Universal S13	300	13	2,8	25,4	6.400	10 11 15 16	■	1
A7440073503213213	Universal S13	350	13	3,0	20	5.500	10 11 15 16	▲	1
A3440073502213213	Universal S13	350	13	3,0	25,4	5.500	10 11 15 16	■	1

Universal S13, for roadbuilding and construction sites

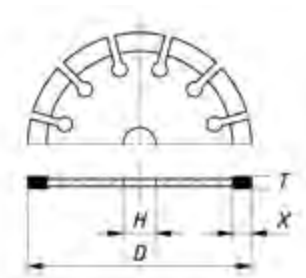
★★★

Ordering example: A3440072301213153

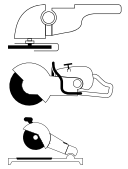
 v_{max.}: 100 m/s
 Ø 230 mm: 80 m/s
 Ø 450 mm: 63 m/s

PG 7

Product number	Description	D mm	Height of segments X mm	Width of segments T mm	H mm	n max. (1/min)	Recommended for Information on page 438		
A7440074003213243	Universal S13	400	13	3,2	20,0	4.800	10 11 15 16		▲ 1
A3440074502213243	Universal S13	450	13	3,2	25,4	2.700	10 11 15 16		■ 1

This diamond disc features:

- three different diamond grinding segments for universal use
- edge-protection function
- forged segments
- optimum cutting speed and service life

Please refer to the chart on page 343 for detailed information on applications.

LD Multi S13, the professional disc for concrete and construction material

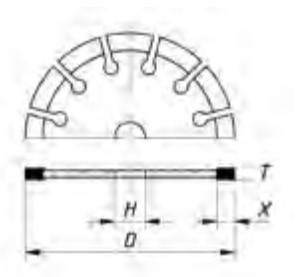
★★★

Ordering example: A344031151213083

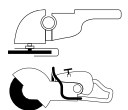
 v_{max.}: 80 m/s
 Ø 300, 350, 400 mm: 100 m/s

PG 7

Product number	Description	D mm	Height of segments X mm	Width of segments T mm	H mm	n max. (1/min)	Recommended for Information on page 438		
A344031151213083	LD Multi S13	115	13	2,4	22,23	13.300	10 11 14		■ 1
A344031251213093	LD Multi S13	125	13	2,4	22,23	12.200	10 11 14		■ 1
A344031501213113	LD Multi S13	150	13	2,4	22,23	10.200	10 11 14		■ 1
A344031801213133	LD Multi S13	180	13	2,4	22,23	8.500	10 11 14		■ 1
A344032301213153	LD Multi S13	230	13	2,6	22,23	6.600	10 11 14		■ 1
A344033002213183	LD Multi S13	300	13	2,8	25,4	6.400	10 11 14		■ 1
A344033502213213	LD Multi S13	350	13	3,0	25,4	5.500	10 11 14		■ 1
A344034002213243	LD Multi S13	400	13	3,2	25,4	4.800	10 11 14		■ 1

This diamond cutting disc excels in:

- Most universal properties along with optimum cutting speed
- Long life
- Extreme running smoothness
- Low vibration due to trapezoid segment geometry
- The production process for the segments in forging technology has been covered by patents

Bonding method: laser welded

Note: Cutting discs with 300 to 400 mm diameter are available on request with 20 mm and 30 mm bore.

Please refer to the chart on page 343 for detailed information on applications.

LD3 S10, for a high cutting rate in concrete and construction material

★★☆

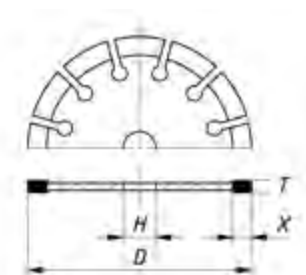

Ordering example: A344131151210083

v_{max.}: 80 m/s
 Ø 300–400 mm: 100 m/s

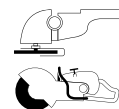

PG 7

Product number	Description	D mm	Height of segments X mm	Width of segments T mm	H mm	n max. (1/min)	Recommended for Information on page 438				PG 7		
A344131151210083	LD3 S10	115	11	2,4	22,23	13.300	10	11	14			■	1
A344131251210093	LD3 S10	125	11	2,4	22,23	12.200	10	11	14			■	1
A344131801210143	LD3 S10	180	11	2,4	22,23	8.500	10	11	14			■	1
A344132301210163	LD3 S10	230	11	2,6	22,23	6.600	10	11	14			■	1
A344133002210163	LD3 S10	300	11	2,8	25,4	6.400	10	11	14			■	1
A344133502210163	LD3 S10	350	11	3,0	25,4	5.500	10	11	14			■	1
A344134002210163	LD3 S10	400	11	3,2	25,4	4.800	10	11	14			■	1

This diamond cutting disc excels in:

- Universal use in concrete/building material
- Excellent price-performance ratio

Bonding method: laser welded

Please refer to the chart on 343 for detailed information on applications.

LD7 S10 for a perfect cutting of asphalt

★★☆

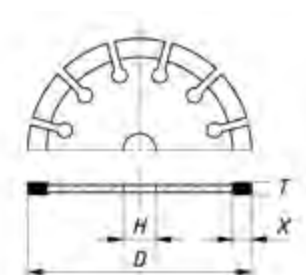

Ordering example: A344173002210183

v_{max.}: 100 m/s
 Ø 450 mm: 63 m/s



PG 7

Product number	Description	D mm	Height of segments X mm	Width of segments T mm	H mm	n max. (1/min)	Recommended for Information on page 438				PG 7		
A344173002210183	LD7 S10	300	11	3,2	25,4	6.400	15	16				■	1
A344173502210213	LD7 S10	350	11	3,2	25,4	5.500	15	16				■	1
A344174002210243	LD7 S10	400	11	3,5	25,4	4.800	15	16				■	1
A344174502210283	LD7 S10	450	11	4,0	25,4	2.700	15	16				■	1

This diamond cutting disc excels in:

- Especially shaped segments providing extreme running smoothness and core protection

Bonding method: laser welded

Note: Cutting discs with 300 to 400 mm diameter are available on request with 20 mm bore.

Please refer to the chart on page 343 for detailed information on applications.

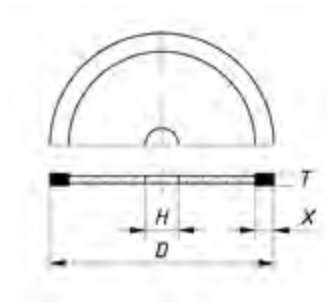
TURBO S 10, the disc for the clear cut in building material or concrete

Ordering example: A344141151110013

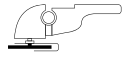
 $v_{max.}: 80 \text{ m/s}$

PG 7

Product number	Description	D mm	Height of segments X mm	Width of segments T mm	H mm	n max. (1/min)	Recommended for Information on page 438		
A344141151110013	TURBO S10	115	10	1,8	22,23	13.300	⑩ ⑪		■ 1
A344141251110013	TURBO S10	125	10	1,8	22,23	12.200	⑩ ⑪		■ 1
A344141801110013	TURBO S10	180	10	2,2	22,23	8.500	⑩ ⑪		■ 1
A344142301110013	TURBO S10	230	10	2,4	22,23	6.600	⑩ ⑪		■ 1

This diamond cutting disc excels in:

- Various applications
- Clear cuts

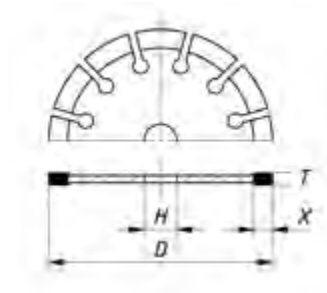
Please refer to the chart on page 343 for detailed information on applications.

BLUE CUT S10, the popular disc for construction sites

Ordering example: A345241151110085

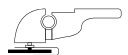
 $v_{max.}: 80 \text{ m/s}$

PG 7

Product number	Description	D mm	Height of segments X mm	Width of segments T mm	H mm	n max. (1/min)	Recommended for Information on page 438		
A345241151110085	Blue Cut S10	115	10	2,0	22,23	13.300	⑩ ⑪		■ 1
A345241251110095	Blue Cut S10	125	10	2,0	22,23	12.200	⑩ ⑪		■ 1
A345241501110125	Blue Cut S10	150	10	2,2	22,23	10.200	⑩ ⑪		■ 1
A345241801110145	Blue Cut S10	180	10	2,4	22,23	8.500	⑩ ⑪		■ 1
A345242301110165	Blue Cut S10	230	10	2,5	22,23	6.600	⑩ ⑪		■ 1

This diamond cutting disc excels in:

- An optimum price-performance ratio

Please refer to the chart on page 343 for detailed information on applications

TC7, the cost-effective turbo disc for a clean cut

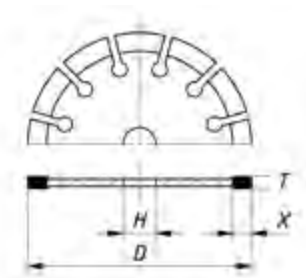

Ordering example: A345241151107775

v_{max.}: 80 m/s

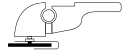

PG 7

Product number	Description	D mm	Height of segments X mm	Width of segments T mm	H mm	n max. (1/min)	Recommended for	Information on page 438		
A345241151107775	TC7	115	7	2,4	22,23	13.300	⑩ ⑪			■ 1
A345241251107775	TC7	125	7	2,6	22,23	12.200	⑩ ⑪			■ 1
A345242301107775	TC7	230	7	3,2	22,23	6.600	⑩ ⑪			■ 1

This diamond cutting disc excels in:

- Clear cuts

Please refer to the chart on page 343 for detailed information on applications.

FAST CUT, the extra thin turbo cutting disc for ceramics and stoneware

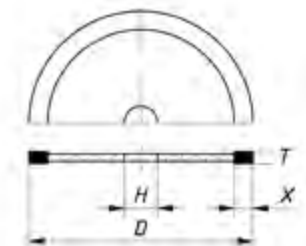

Ordering example: A344091151110013

v_{max.}: 80 m/s

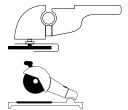

PG 7

Product number	Description	D mm	Height of segments X mm	Width of segments T mm	H mm	n max. (1/min)	Recommended for	Information on page 438		
A344091151110013	FAST CUT S10	115	10	1,4	22,23	13.300	⑫ ⑭			■ 1
A344091251110013	FAST CUT S10	125	10	1,4	22,23	12.200	⑫ ⑭			■ 1
A344091502107013	FAST CUT S7	150	7	1,4	25,4/22,23	10.200	⑫ ⑭			■ 1
A344091802107013	FAST CUT S7	180	7	1,6	25,4/22,23	8.500	⑫ ⑭			■ 1
A344092301107013	FAST CUT S7	230	7	1,6	22,23	6.600	⑫ ⑭			■ 1
A344092504107013	FAST CUT S7	250	7	1,6	30,0	6.150	⑫ ⑭			■ 1
A344093004107013	FAST CUT S7	300	7	2,2	30,0	5.100	⑫ ⑭			■ 1
A344093504107013	FAST CUT S7	350	7	2,2	30,0	4.400	⑫ ⑭			■ 1

This diamond cutting disc excels in:

- An extra-thin segment coating and a reinforced flange area
- Fast and clear cuts through the hardest tiles

Please refer to the chart on page 343 for detailed information on applications.

FLIESE S7, the popular cutting disc for tiles and ceramics

★★☆☆

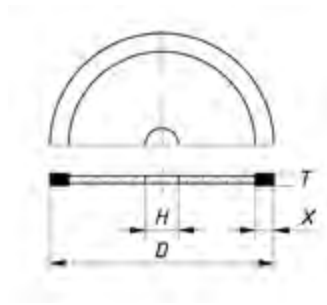

Ordering example: A344111151107013

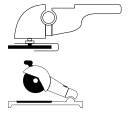
 $v_{max.}: 80 \text{ m/s}$

PG 7

Product number	Description	D mm	Height of segments X mm	Width of segments T mm	H mm	n max. (1/min)	Recommended for Information on page 438			
A344111151107013	FLIESE S7	115	7	1,6	22,23	13.300	⑫		■	1
A344111251107013	FLIESE S7	125	7	1,6	22,23	12.200	⑫		■	1
A744111502107013	FLIESE S7	150	7	1,6	25,4/22,23	10.200	⑫		▲	1
A744111802107013	FLIESE S7	180	7	2,0	25,4/22,23	8.500	⑫		▲	1
A344112301107013	FLIESE S7	230	7	2,0	22,23	6.600	⑫		■	1
A744112504107013	FLIESE S7	250	7	2,1	30,0	6.150	⑫		▲	1
A744113004107013	FLIESE S7	300	7	2,2	30,0	5.100	⑫		▲	1
A744113504107013	FLIESE S7	350	7	2,3	30,0	4.400	⑫		▲	1

This diamond cutting disc excels in:

- Clean cuts into glazed ceramics

Please refer to the chart on page 343 for detailed information on applications.

FC7, the cost-effective tile cutting disc

★☆☆☆

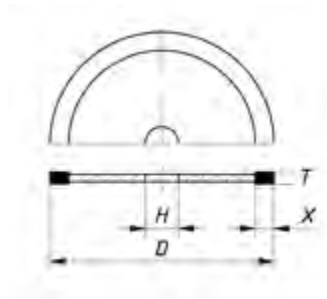

Ordering example: A345211151107015

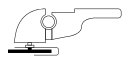
 $v_{max.}: 80 \text{ m/s}$

PG 7

Product number	Description	D mm	Height of segments X mm	Width of segments T mm	H mm	n max. (1/min)	Recommended for Information on page 438			
A345211151107015	FC7	115	7	1,8	22,23	13.300	⑫		■	1
A345211251107015	FC7	125	7	2,0	22,23	12.200	⑫		■	1
A345212301107015	FC7	230	7	2,5	22,23	6.600	⑫		■	1

This diamond cutting disc excels in:

- An optimum price-performance ratio

Please refer to the chart on page 343 for detailed information on applications.

DST SP S5 to meet the highest expectations for stock removal and smooth running

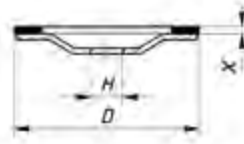

Ordering example: A3444B1251606183

v_{max.}: 80 m/s

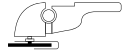

PG 7

Product number	Description	D mm	Height of segments X mm	H mm	n max. (1/min)	Recommended for Information on page 438		
A3444B1251606183	DST SP S5	125	5	22,23	12.200	10 11 14 15		■ 1
A3444B1801606183	DST SP S5	180	5	22,23	8.500	10 11 14 15		■ 1

This diamond cup wheel excels in:

- High performance segments for maximum stock removal
- Universal segment alloy for concrete/granite
- Low vibration during working due to inductive welded segments (no imbalance in tool)
- Optimum suction at segment

Please refer to the chart on page 343 for detailed information on applications.

Cutting, Rough Grinding (diamond)

DST S6, the cup wheel for universal application

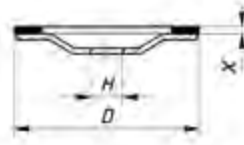

Ordering example: A344431151506053

v_{max.}: 80 m/s

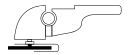

PG 7

Product number	Description	D mm	Height of segments X mm	H mm	n max. (1/min)	Recommended for Information on page 438		
A344431151506053	DST S6	115	6	22,23	13.300	10 11		■ 1
A344431251506053	DST S6	125	6	22,23	12.200	10 11		■ 1
A344431801506053	DST S6	180	6	22,23	8.500	10 11		■ 1

This diamond cup wheel excels in:

- Excellent price-performance ratio
- Optimum arrangement of segments for high grinding performance and clean surface

Please refer to the chart on page 343 for detailed information on applications.

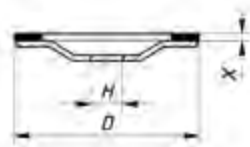
DST S5, the cost-effective cup wheel for numerous application

Ordering example: A345531151607185

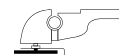
 $v_{max.}: 80 \text{ m/s}$

PG 7

Product number	Description	D mm	Height of segments X mm	H mm	n max. (1/min)	Recommended for	Information on page 438				
A345531151607185	DST S5	115	5	22,23	13.300	⑩ ⑪				■	1
A345531251607185	DST S5	125	5	22,23	12.200	⑩ ⑪				■	1

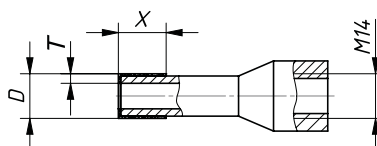
Please refer to the chart on page 343 for detailed information on applications.

Diamond dry drill

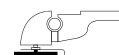
Ordering example: A345890066315013



PG 7

Product number	Description	D mm	Height of segments X mm	Width of segments T mm	Thread	n max. (1/min)	Recommended for	Information on page 438			
A345890066315013	DTB 06	6	9	3,0	M14	13.300	⑫			■	1
A345890086315013	DTB 08	8	9	3,0	M14	13.300	⑫			■	1
A345890106315013	DTB 10	10	9	3,0	M14	13.300	⑫			■	1
A345890126315013	DTB 12	12	9	3,0	M14	13.300	⑫			■	1
A345890146315013	DTB 14	14	9	3,0	M14	13.300	⑫			■	1
A345890206315013	DTB 20	20	9	3,0	M14	13.300	⑫			■	1
A345890256315013	DTB 25	25	9	3,0	M14	13.300	⑫			■	1
A345890326315013	DTB 32	32	9	3,0	M14	13.300	⑫			■	1
A345890386315013	DTB 38	38	9	3,0	M14	13.300	⑫			■	1
A345890456315013	DTB 45	45	9	3,0	M14	13.300	⑫			■	1
A345890586315013	DTB 58	58	9	3,0	M14	13.300	⑫			■	1
A345890686315013	DTB 68	68	9	3,0	M14	13.300	⑫			■	1

This diamond dry drill features:

- use on standard angle grinders
- clean tile drilling without fractured areas
- universal use in the building and plumbing trade

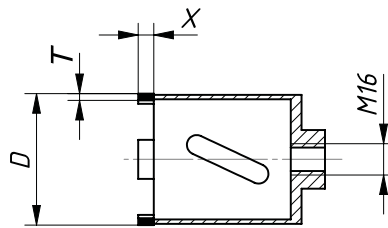
Drill bit for socket outlets DSK



Ordering example: A346350687208043

Please order also the relevant accessory set.



PG 7

Product number	Description	D mm	Height of segments X mm	Width of segments T mm	Thread	n max. (1/min)	Recommended for	Information on page 438		PG 7	Icon	
A346350687208043	DSK 68	68	8	3,5	M16	4.000	⑩ ⑪				■	1
A346350827208043	DSK 82	82	8	3,5	M16	4.000	⑩ ⑪				■	1

This drill bit features:

- quick and easy relocation of empty sockets in electrical installations
- use on standard drilling machines
- mounting in three-jaw chucks or SDS quick-release systems

Cutting, Rough Grinding (diamond)

Accessory set for drill bit for socket outlets



Ordering example: A346390006



PG 7

Product number	Description	Contents	Recommended for	Information on page 438		PG 7	Icon
A346390006	Accessory set DSK	Hex adapter, centre drill bit, drift key				■	1
A346390SDS	Accessory set DSK	SDS adapter, centre drill bit, drift key				■	1

Technical Brushes

354 General Information

355 Cylindrical brush, shaft mounted

355 Cylindrical brush of abrasive nylon

356 Conical brush

356 End brush, shaft mounted

357 Pipe brush

358 Wheel brush

359 Cup wheel brush

359 Hand brush

Product line marking

The product lines are illustrated by star symbols at the top of the table; please refer to page **14** and **15**.

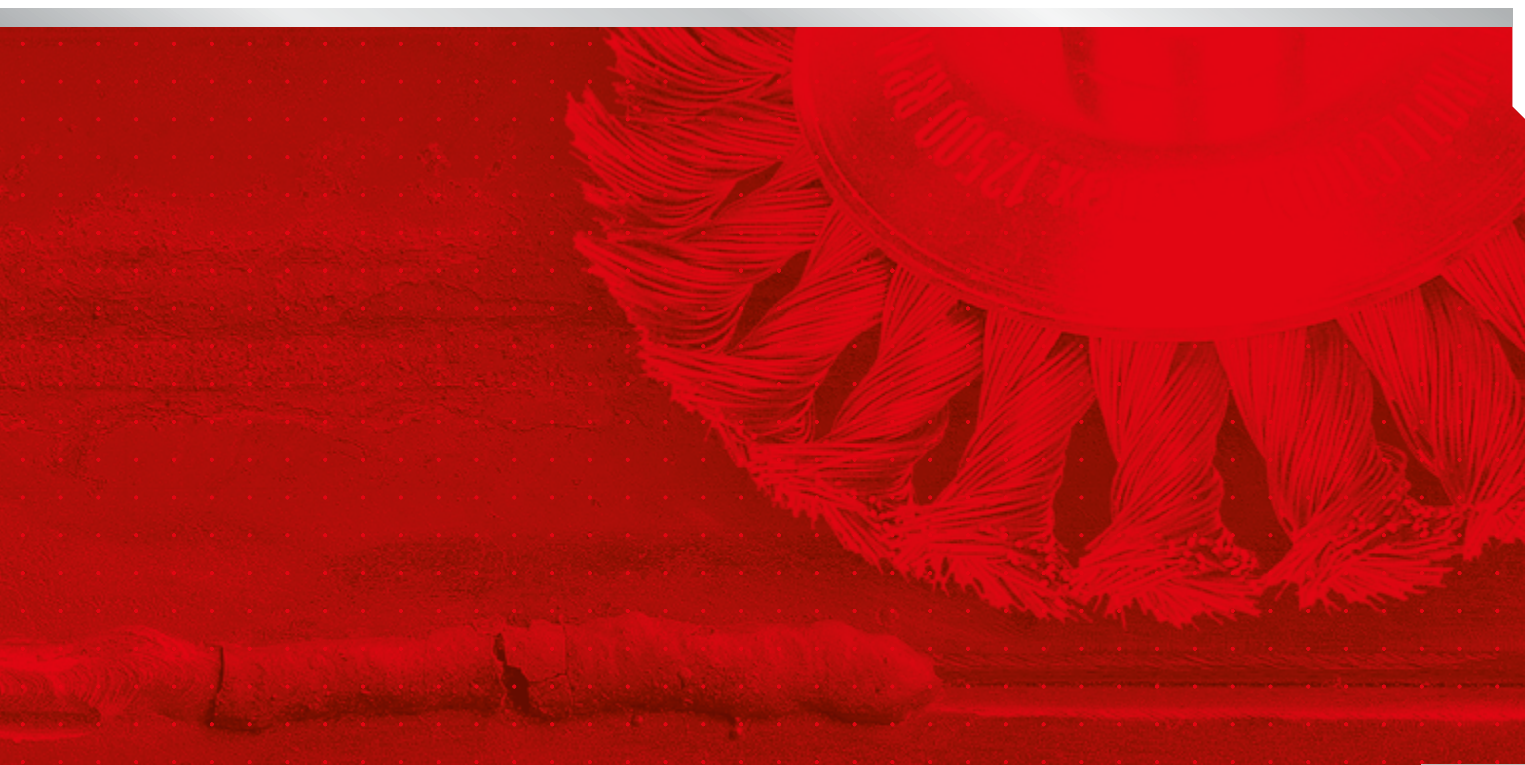
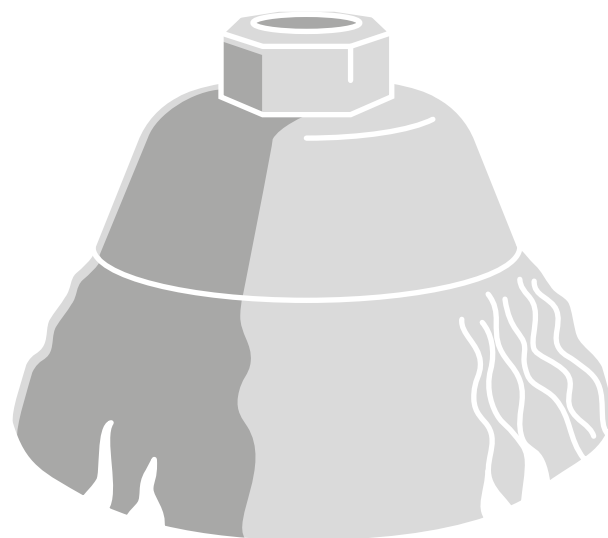

General Information

Filament Quality and Style

Quality steel wire

Using quality steel wire with a high tensile strength; this gives long and economical tool life.

Stainless steel wire

This wire is used where residues from normal steel wire would affect surfaces such as stainless steel, aluminium and other nonferrous metals.

Nylon filaments, abrasive impregnated

Abrasive impregnated nylon filaments are very flexible and follow the contour of the workpiece without being too aggressive; in use, new abrasive is exposed to the workpiece at all times thus resulting in a constant performance and long life.

Style

Brushes are manufactured in both steel wire qualities with crimped 'or twist knotted style. Brushes with twist knotted steel wire meet the most extreme demands and normally achieve longer tool life compared to crimped wire brushes. Brushes are also manufactured from crimped wire embedded in a resin bond. This style features higher performance and is ideally suited to achieve uniform surfaces and precise edges.

Application

Our wire brushes accommodate most of the ever increasing number of applications, like deburring, descaling, derusting, surface cleaning, fettling, roughening and paint stripping. Brushes manufactured with abrasive impregnated nylon filaments are ideally suited to remove stain from metal surfaces, for graining of soft wood, car body repair jobs, stripping of paint residues.

Working mode and machines

Technical brushes are flexible tools which follow the contour of the workpiece.

In order to achieve best results, only the tip of the filament should be in contact with the workpiece. In order to achieve best results, only the tip of the filament should be in contact with the workpiece. The elasticity of the brush depends on the exposed length of the filaments; for wire brushes, the wire diameter is an important factor. Brushes with very long filaments are extremely flexible and must be used with low pressure only. High pressure reduces the life of the brush and creates higher wear. Technical brushes can be used on stationary and off-hand machines.

Operating speeds

Wire brushes act harder with increasing speed and softer with lower speed:

Machining of steel	approx.	30 m/s
Machining of non-ferrous metals	approx.	18–20 m/s
Machining of plastic	approx.	15 m/s

Twist knotted wire brushes may be operated at higher speeds, for instance:

Machining of steel:	approx.	40 m/s.
---------------------	---------	---------

Brushes made from nylon filaments achieve best results at operating speeds between 18 and 20 m/s, depending on the material to be machined.

Safety instructions

Technical brushes are manufactured under strict quality control (according to EN 1083-2). It is recommended to wear safety clothing when working with technical brushes.

BS, Cylindrical brush, Shank 6 mm

★★☆☆

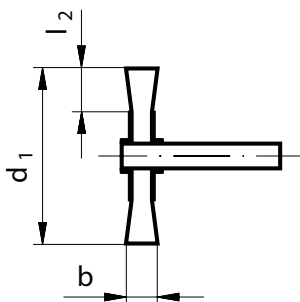

Ordering example: A350005026



PG 3

Product number	Description	Material	Type	d ₁ mm	b mm	l ₂ mm	Wire Ø	n max. (1/min)	Recommended for Information on page 438				
A35010401011	BSSW 04010	steel	crimped	40	10	9	0,2	18.000	①	⑤	⑧	■	10
A351004036	BSVW 04011	stainless	crimped	40	11	9	0,2	18.000	② ③ ④	⑦		■	10
A350005026	BSSW 05010	steel	crimped	50	10	12	0,2	15.000	①	⑤	⑧	■	10
A350105014111	BSSW 05014	steel	crimped	50	14	12	0,2	15.000	①	⑤	⑧	■	10
A350105014211	BSVW 05014	stainless	crimped	50	14	12	0,2	15.000	② ③ ④	⑦		■	10
A350006036	BSSW 06018	steel	crimped	60	16	12	0,2	15.000	①	⑤	⑧	■	10
A351006036	BSVW 06018	stainless	crimped	60	16	17	0,2	15.000	①	⑤	⑧	■	10
A350106018113	BSSW 06018	steel	crimped	60	19	17	0,3	15.000	② ③ ④	⑦		■	10
A350007036	BSSW 07018	steel	crimped	70	16	19	0,2	15.000	①	⑤	⑧	■	10
A350107018113	BSSW 07018	steel	crimped	70	16	19	0,3	15.000	①	⑤	⑧	■	10
A350107018213	BSVW 07018	stainless	crimped	70	16	19	0,3	15.000	② ③ ④	⑦		■	10
A351007036	BSVW 07018	stainless	crimped	70	16	19	0,2	15.000	② ③ ④	⑦		■	10
A350107508135	BSSZ 07508	steel	knotted	75	12	15	0,5	25.000	①	⑤		■	10
A350107508235	BSVZ 07508	stainless	knotted	75	12	15	0,5	25.000	② ③ ④			■	10

BSN, Cylindrical brush of abrasive nylon, Shank 6 mm

★★☆☆

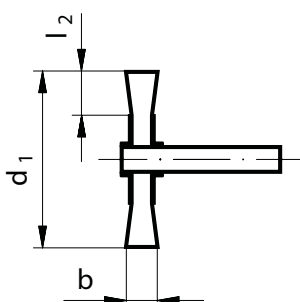

Ordering example: A350105010048



PG 3

Product number	Description	Type	d ₁ mm	b mm	l ₂ mm	n max. (1/min)	Recommended for Information on page 438		
A350105010048	BSNG 05010	coarse	50	10	12	15.000	② ④ ⑥ ⑦ ⑧	■	10
A350105010049	BSNF 05010	fine	50	10	12	15.000	② ④ ⑥ ⑦ ⑧	■	10
A350107012048	BSNG 07012	coarse	70	12	20	15.000	② ④ ⑥ ⑦ ⑧	■	10
A350107012049	BSNF 07012	fine	70	12	20	15.000	② ④ ⑥ ⑦ ⑧	■	10
A350110007048	BSNG 10007	coarse	100	8	22	4.500	② ④ ⑥ ⑦ ⑧	■	10
A350110008050	BSNF 10008	fine	100	8	22	4.500	② ④ ⑥ ⑦ ⑧	■	10

● Inox/Steel

● Steel

● Aluminium

● Stone

● Cast material

● Plastic

● Titanium

BK, Conical brushes

★★☆

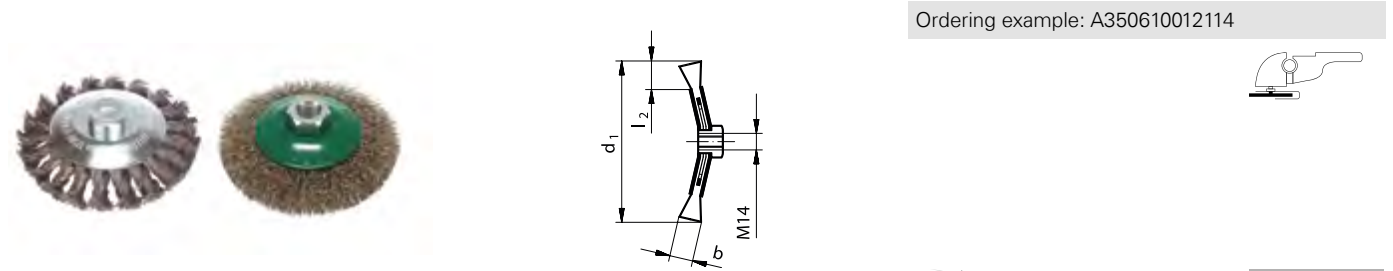

Ordering example: A350610012114

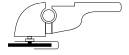

Product number	Description	Material	Type	d ₁ mm	b mm	l ₂ mm	Thread	Wire Ø	n max. (1/min)	Recommended for Information on page 438	PG 3	
											■	☐
A350610012213	BKVW 10012	stainless	crimped	100	10	20	M14	0,3	12.500	2 3 4 7	■	1
A350610012114	BKSW 10012	steel	crimped	100	10	20	M14	0,35	12.500	1 5	■	1
A350610013235	BKVZ 10013	stainless	knotted	100	13	20	M14	0,5	12.500	2 3 4 7	■	1
A350610013135	BKSZ 10013	steel	knotted	100	13	20	M14	0,5	12.500	1 5	■	1

BP, End brush, Shank 6 mm

★★☆

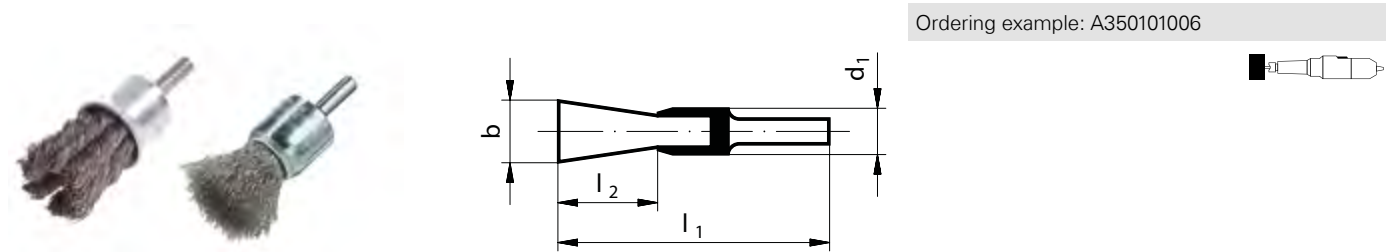

Ordering example: A350101006



Product number	Description	Material	Type	d ₁ mm	b mm	l ₂ mm	l ₁ mm	Wire Ø	n max. (1/min)	Recommended for Information on page 438	PG 3	
											■	☐
A350101006	BPSW 01020	steel	crimped	10	10	20	60	0,3	20.000	1 5 8	■	10
A351101006	BPVW 01020	stainless	crimped	10	10	20	60	0,3	20.000	2 3 4 7	■	10
A350101506	BPSW 01725	steel	crimped	16	17	22	65	0,3	20.000	1 5 8	■	10
A351101506	BPVW 01725	stainless	crimped	16	17	22	65	0,3	20.000	2 3 4 7	■	10
A350502029134	BPSZ 02029	steel	knotted	19	20	28	72	0,35	20.000	1 5	■	10
A350502029232	BPVZ 02029	stainless	knotted	19	20	28	72	0,25	20.000	2 3 4 7	■	10
A350102206	BPSW 02525	steel	crimped	22	25	25	68	0,3	18.000	1 5 8	■	10
A351102206	BPVW 02525	stainless	crimped	22	25	25	68	0,3	18.000	2 3 4 7	■	10
A350502329134	BPSZ 02329	steel	knotted	22	23	28	72	0,35	20.000	1 5	■	10
A350102806	BPSW 03025	steel	crimped	29	30	25	68	0,3	18.000	1 5 8	■	10
A351102806	BPVW 03025	stainless	crimped	29	30	25	68	0,3	18.000	2 3 4 7	■	10

Cleaning

RBSD, pipe brush, crimped wire

★★☆☆

Ordering example: A359901025



PG 3

Product number	Description	Material	Type	d ₁ mm	l ₂ mm	d ₃ mm	l ₁ mm	Wire Ø	n max. (1/min)	Recommended for Information on page 438		
A359901025	RBSD 1025	steel	crimped	10	25	3,8	90	0,12	2.000	① ② ③ ⑤ ⑧	■	10
A359901325	RBSD 1325	steel	crimped	13	25	3,8	90	0,12	2.000	① ② ③ ⑤ ⑧	■	10
A359901625	RBSD 1625	steel	crimped	16	25	3,8	90	0,12	2.000	① ② ③ ⑤ ⑧	■	10
A359902525	RBSD 2525	steel	crimped	25	25	3,8	90	0,2	2.000	① ② ③ ⑤ ⑧	■	10

Ideal for

deburring of

- bores
- cross-holes
- O-ring grooves

polishing and cleaning of

- injectors/nozzles
- small bores
- threaded bores

RBSN, pipe brush of abrasive nylon, silicon carbide

★★☆☆

Ordering example: A359901065120



PG 3

Product number	Description	Quality	d ₁ mm	l ₂ mm	d ₃ mm	l ₁ mm	Wire Ø	n max. (1/min)	Recommended for Information on page 438		
A359901065120	RBSN 1065	C 120	10	65	3,7	125	0,6	2.000	② ④ ⑥ ⑦ ⑧	■	10
A359901365120	RBSN 1365	C 120	13	65	3,7	125	0,6	2.000	② ④ ⑥ ⑦ ⑧	■	10
A359901665120	RBSN 1665	C 120	16	65	5,2	125	0,6	2.000	② ④ ⑥ ⑦ ⑧	■	10
A359902565120	RBSN 2565	C 120	25	65	5,5	125	0,6	2.000	② ④ ⑥ ⑦ ⑧	■	10

Ideal for

deburring of

- bores
- cross-holes
- O-ring grooves

polishing and cleaning of

- injectors/nozzles
- small bores
- threaded bores

Inox/Steel

Steel

Aluminium

Stone

Cast material

Plastic

Titanium

BR, Wheel brush, twist knotted

★★☆

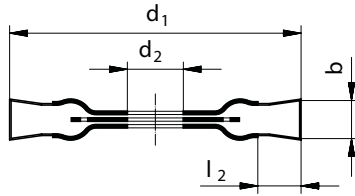

Ordering example: A350211512135

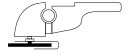

PG 3

Product number	Description	Material	Type	d ₁ mm	b mm	d ₂ mm	l ₂ mm	Wire Ø	n max. (1/min)	Recommended for Information on page 438		
A350211512135	BRSZ 11512	steel	knotted	115	14	22,23	20	0,5	12.500	1	5	■ 1
A350211512234	BRVZ 11512	stainless	knotted	115	14	22,23	20	0,35	12.500	2	3 4 7	■ 1
A350312514135	BRSZ 12514	steel	knotted	125	14	22,23	20	0,5	12.500	1	5	■ 1
A350312514235	BRVZ 12514	stainless	knotted	125	14	22,23	20	0,5	12.500	2	3 4 7	■ 1
A350317814135	BRSZ 17814	steel	knotted	178	14	22,23	32	0,5	9.000	1	5	■ 1

BR, Wheel brush, crimped wire

★★☆

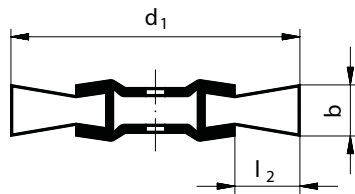

Ordering example: A350315022114

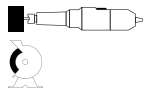

PG 3

Product number	Description	Material	Type	d ₁ mm	b mm	R mm	l ₂ mm	Wire Ø	n max. (1/min)	Recommended for Information on page 438		
A350315022114	BRSW 15022	steel	crimped	150	22	40	33	0,35	6.000	1	5	■ 1
A350315023213	BRVW 15023	stainless	crimped	150	23	50	33	0,3	6.000	2	3 4 7	■ 1
A350320024114	BRSW 20024	steel	crimped	200	24	50	48	0,35	6.000	1	5	■ 1

All brushes are supplied with adapters sets for easy mounting on all popular grinding machines.

The adapters have the following dimensions:

- tube "R" 40 mm: 40 / 32 / 1" / 22,23 / 20 / 16 1/2"
- tube "R" 50 mm: 50 / 32 / 1" / 22,23 / 20 / 16 1/2"

Please take note of the technical advices for the correct and safe assembly.
The corresponding information leaflet is included in our packing



BTG, Cup brush with thread

★★☆☆

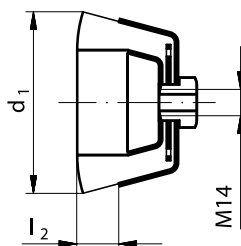

Ordering example: A350406020114

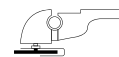

PG 3

Product number	Description	Material	Type	d ₁ mm	l ₂ mm	Thread	Wire Ø	n max. (1/min)	Recommended for Information on page 438							
A350406020114	BTSW 06020 G	steel	crimped	60	20	M14	0,35	12.000	1		5			■	1	
A350406021213	BTVW 06021 G	stainless	crimped	60	20	M14	0,3	12.000		2	3	4		7	■	1
A350406520234	BTVZ 06520 G	stainless	knotted	65	20	M14	0,35	12.500		2	3	4		7	■	1
A350406520135	BTSZ 06520 G	steel	knotted	65	20	M14	0,5	12.500	1					5	■	1
A350408020135	BTSZ 08020 G	steel	knotted	80	20	M14	0,5	9.000	1					5	■	1
A350408025114	BTSW 08025 G	steel	crimped	80	25	M14	0,35	8.500	1					5	■	1
A350410030114	BTSW 10030 G	steel	crimped	100	30	M14	0,35	9.000	1					5	■	1

BHU, Hand brush for universal application

★★☆☆

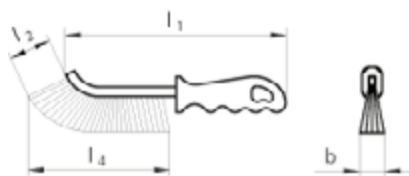

Ordering example: A350726525113



PG 3

Product number	Description	Material	b mm	l ₂ mm	l ₁ mm	l ₄ mm	Wire Ø	Recommended for Information on page 438							
A350726525113	BHUS 26528	steel	15	28	265	130	0,35	1		5			■	1	
A350726525213	BHUV 26525	stainless	15	28	265	130	0,3		2	3	4		7	■	1

SPR, Economy Rolls, reg. Aluminium Oxide



Ordering example: A3821025040

NK = reg. Aluminium Oxide

PG 8

Product number	Description	Grit	Thickness mm	Length m	Recommended for Information on page 438		
A3821025040	SPR 025	NK 40	25	50	① ② ③ ④ ⑤ ⑥ ⑦ ⑧	■	1
A3821025060	SPR 025	NK 60	25	50	① ② ③ ④ ⑤ ⑥ ⑦ ⑧	■	1
A3821025080	SPR 025	NK 80	25	50	① ② ③ ④ ⑤ ⑥ ⑦ ⑧	■	1
A3821025100	SPR 025	NK 100	25	50	① ② ③ ④ ⑤ ⑥ ⑦ ⑧	■	1
A3821025120	SPR 025	NK 120	25	50	① ② ③ ④ ⑤ ⑥ ⑦ ⑧	■	1
A3821025150	SPR 025	NK 150	25	50	① ② ③ ④ ⑤ ⑥ ⑦ ⑧	■	1
A3821025180	SPR 025	NK 180	25	50	① ② ③ ④ ⑤ ⑥ ⑦ ⑧	■	1
A3821025240	SPR 025	NK 240	25	50	① ② ③ ④ ⑤ ⑥ ⑦ ⑧	■	1
A3821025320	SPR 025	NK 320	25	50	① ② ③ ④ ⑤ ⑥ ⑦ ⑧	■	1
A3821025400	SPR 025	NK 400	25	50	① ② ③ ④ ⑤ ⑥ ⑦ ⑧	■	1
A3821040040	SPR 040	NK 40	40	50	① ② ③ ④ ⑤ ⑥ ⑦ ⑧	■	1
A3821040060	SPR 040	NK 60	40	50	① ② ③ ④ ⑤ ⑥ ⑦ ⑧	■	1
A3821040080	SPR 040	NK 80	40	50	① ② ③ ④ ⑤ ⑥ ⑦ ⑧	■	1
A3821040100	SPR 040	NK 100	40	50	① ② ③ ④ ⑤ ⑥ ⑦ ⑧	■	1
A3821040120	SPR 040	NK 120	40	50	① ② ③ ④ ⑤ ⑥ ⑦ ⑧	■	1
A3821040150	SPR 040	NK 150	40	50	① ② ③ ④ ⑤ ⑥ ⑦ ⑧	■	1
A3821040180	SPR 040	NK 180	40	50	① ② ③ ④ ⑤ ⑥ ⑦ ⑧	■	1
A3821040240	SPR 040	NK 240	40	50	① ② ③ ④ ⑤ ⑥ ⑦ ⑧	■	1
A3821040320	SPR 040	NK 320	40	50	① ② ③ ④ ⑤ ⑥ ⑦ ⑧	■	1
A3821040400	SPR 040	NK 400	40	50	① ② ③ ④ ⑤ ⑥ ⑦ ⑧	■	1

LUKAS Economy Rolls with their great grinding characteristics help to manage your manual grinding at optimum level.

Cleaning

SLB, Sheets of abrasive cloth



Ordering example: A3825230280040

NK = reg. Aluminium Oxide

PG 8

Product number	Description	Quality	Thickness mm	Length mm	Recommended for Information on page 438		
A3825230280040	SLB 230280	NK 40	230	280	① ② ③ ④ ⑤ ⑥ ⑦ ⑧	■	50
A3825230280060	SLB 230280	NK 60	230	280	① ② ③ ④ ⑤ ⑥ ⑦ ⑧	■	50
A3825230280080	SLB 230280	NK 80	230	280	① ② ③ ④ ⑤ ⑥ ⑦ ⑧	■	50
A3825230280100	SLB 230280	NK 100	230	280	① ② ③ ④ ⑤ ⑥ ⑦ ⑧	■	50
A3825230280120	SLB 230280	NK 120	230	280	① ② ③ ④ ⑤ ⑥ ⑦ ⑧	■	50
A3825230280150	SLB 230280	NK 150	230	280	① ② ③ ④ ⑤ ⑥ ⑦ ⑧	■	50
A3825230280180	SLB 230280	NK 180	230	280	① ② ③ ④ ⑤ ⑥ ⑦ ⑧	■	50
A3825230280220	SLB 230280	NK 220	230	280	① ② ③ ④ ⑤ ⑥ ⑦ ⑧	■	50
A3825230280240	SLB 230280	NK 240	230	280	① ② ③ ④ ⑤ ⑥ ⑦ ⑧	■	50
A3825230280320	SLB 230280	NK 320	230	280	① ② ③ ④ ⑤ ⑥ ⑦ ⑧	■	50
A3825230280400	SLB 230280	NK 400	230	280	① ② ③ ④ ⑤ ⑥ ⑦ ⑧	■	50
A3825230280999	SLB 230280	NK 999	230	280	① ② ③ ④ ⑤ ⑥ ⑦ ⑧	■	50

The LUKAS-sheets of abrasive cloth with optimum abrasive properties will enable you to achieve outstanding results with your manual grinding applications.

SVB, Fleece Pads



Ordering example: A380115023011

A = reg. Aluminium Oxide

C = Silicon carbide

PG 8

Product number	Description	Quality	Type	Thickness mm	Length mm	Recommended for Information on page 438		
A380115023011	SVB 150230	A Medium	red-brown	150	230	① ② ③ ④ ⑤ ⑥ ⑦ ⑧	■	10
A380115023012	SVB 150230	A Fine	green	150	230	① ② ③ ④ ⑤ ⑥ ⑦ ⑧	■	10
A380115023013	SVB 150230	A Very Fine	red-brown	150	230	① ② ③ ④ ⑤ ⑥ ⑦ ⑧	■	10
A380115023024	SVB 150230	C Ultra Fine	green	150	230	① ② ③ ④ ⑤ ⑥ ⑦ ⑧ ⑨	■	10

LUKAS-fleece pads are used to remove corrosion and stain from metal surfaces as well as to clean and polish surfaces of any kind of material.

SVR, Fleece Rolls



Ordering example: A382011501012

A = reg. Aluminium Oxide

C = Silicon carbide

PG 8

Product number	Description	Quality	Type	Thickness mm	Length m	Recommended for Information on page 438		
A382011501012	SVR 115	A Fine	green	115	10	① ② ③ ④ ⑤ ⑥ ⑦ ⑧	■	1
A382011501013	SVR 115	A Very Fine	red-brown	115	10	① ② ③ ④ ⑤ ⑥ ⑦ ⑧	■	1
A382011501024	SVR 115	C Ultra Fine	grey	115	10	① ② ③ ④ ⑤ ⑥ ⑦ ⑧ ⑨	■	1

LUKAS-fleece rolls are used to remove corrosion and stain from metal surfaces as well as to clean and polish surfaces of any kind of material.

AS-Cleaning fleece

197 Qualities and Applications

366 General Information

367 ASVS, abrasive discs for flexible boring and drilling machines

367 ASB, mounting arbor for ASVS

368 ASVT, for right angle grinders, with reinforced fibre backing

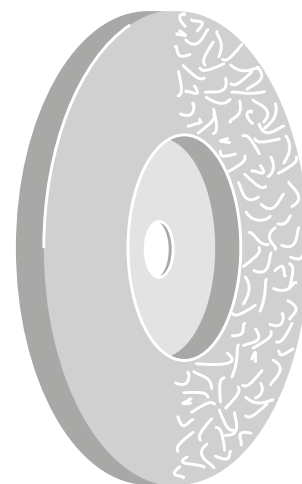

Product line marking

The product lines are illustrated by star symbols at the top of the table; please refer to page **14** and **15**.



Information

General Information

Our AS surface preparation fleece consists of a coarse Polyamide fleece impregnated with aggressive abrasive grit particles.

Recommendations for use

Products using our AS surface preparation fleece are ideally suited for the following applications:

- removal of paint and adhesives
- removal of cement and concrete residues
- de-rusting, restoring and polishing of a wide variety of surfaces
- graining and the finishing of wood
- de-rusting and preparation work on boats and ships, eg, removing barnacles
- surface preparation of floors and various applications for car-body repair work
- preparation work on welding seams – before and after welding

Safety regulations

Please take care that our recommended cutting speed is not exceeded.

Characteristics

- less generation heat
- “soft” grinding action
- no glazing/loading
- no damage to workpieces

ASVS, Abrasive discs for flexible boring and drilling machines

★★☆☆

Ordering example: A22900601201

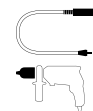
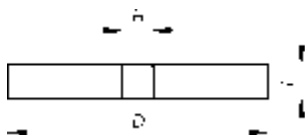

PG 8

Product number	Description	D mm	T mm	H mm	n recom. (1/min)	n max (1/min)	Retaining bolt	Recommended for Information on page 438		
A22900601201	ASVS 060	60	13	13	8.000	9.500	ASB 6	① ② ③ ④ ⑤ ⑥ ⑦ ⑧ ⑨	■	10
A22901001201	ASVS 100	100	13	13	5.000	5.700	ASB 6	① ② ③ ④ ⑤ ⑥ ⑦ ⑧ ⑨	■	10
A22901251201	ASVS 125	125	13	13	4.000	4.500	ASB 8	① ② ③ ④ ⑤ ⑥ ⑦ ⑧ ⑨	■	10
A22901501201	ASVS 150	150	13	13	3.000	3.800	ASB 8	① ② ③ ④ ⑤ ⑥ ⑦ ⑧ ⑨	■	10

ASB, Mounting arbor for ASVS, incl. spring washer and nut

★★☆☆

Ordering example: A1610021007301

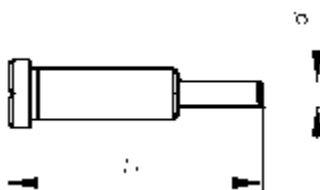

PG 8

Product number	Description	d ₁ mm	d ₂ mm	l ₁ mm	Recommended for Information on page 438		
A1610021007301	ASB 06	M12	6	60		■	1
A1610021007302	ASB 08	M12	8	60		■	1

ASVT, for angle grinder, with reinforced fibre backing

★★☆

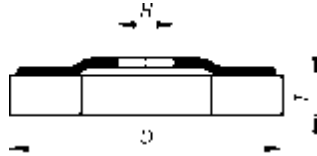

Ordering example: A270111500114

v_{max.}: 63 m/s

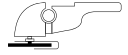

PG 8

Product number	Description	D mm	T mm	H mm	n recom. (1/min)	n max. (1/min)	Recommended for		
A270111500114	ASVT 115	115	13	22,23	5.300	10.500	① ② ③ ④ ⑤ ⑥ ⑦ ⑧ ⑨	■	10
A270112500114	ASVT 125	125	13	22,23	4.900	9.600	① ② ③ ④ ⑤ ⑥ ⑦ ⑧ ⑨	■	10

Usable without supporting-plate on adjustable and slow-speed angle grinders.

Power Tools

370 Technical Information

Pneumatic Angle Grinders

372 Belt grinding machine

373 Straight grinder

Power tools

382 Conditioning machine

Product line marking

The product lines are illustrated by star symbols at the top of the table; please refer to page **14** and **15**.

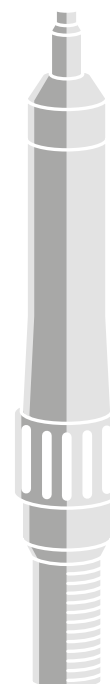

Technical Information

General information

High performance and low air consumption are the major features of LUKAS air tools. The robust vane motors can be stopped under load without causing any damage. Speed governors are used to prevent exceeding of the idling speed within the specified tolerance. The tool design is maintenance and service friendly. It facilitates the change of wear parts.

Compressed air supply

Power tools already achieve maximum performance levels from a flow pressure of 0.63 MPa (= 6.3 bar). We are more than happy to provide advice when it comes to the optimum design of your compressed air supply. Please refer to the technical information for initial specifications on line cross sections (diagram).

Vane motor lubrication	Air consumption
0,05–0,5 m ³ /min	G 1/4"
0,15–0,9 m ³ /min	G 3/8"
0,5–1,5 m ³ /min	G 1/2"
0,8–6,0 m ³ /min	G 3/4"

Vane motor lubrication

A maintenance unit consisting of a water trap and lubricator reliably protects the vane motors against wear, reduces the maintenance effort and increases the service life.

Ergonomics and safety

Vibration

All air tools are tested and labelled in accordance with the current European noise and vibration directive to protect the user. Vibrations are recorded and calculated three-dimensionally in this respect.

Ergonomie

When compared to electric power tools, pneumatic tools offer a higher level of performance and lower weight. Ergonomically shaped, insulated handles mean that the machines can be held easily, thus enabling fatigue-free working. Machining of workpieces which are difficult to access also presents no problem with LUKAS pneumatic tools, as the spindle length, air outlet and valve design of many machines can be optimized to suit user requirements.

Safety

Use is even possible in potentially hazardous atmospheres.

Quality

All machines have a robust aluminium housing and are designed for use in a harsh environment. Motors do not overheat, even during continuous operation at a maximum performance level. In the context of 100% quality control all machines undergo speed and performance measurements prior to delivery.

Safety instruction

Only tools which are safe and approved for operation at the peripheral speeds achieved with respective tools should be used.

Overview of pneumatic angle grinders

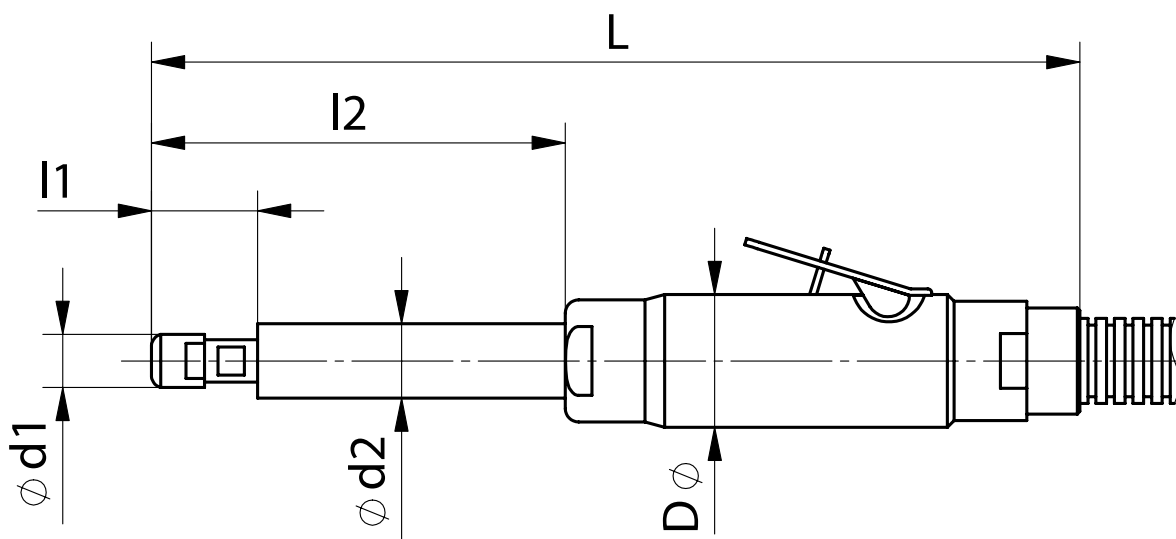

Technical specifications

Description	Rotational speed min-1	Power consumption kW	d1 mm	l1 mm	d2 mm	l2 mm	D mm	L mm	Page
AMIN 30 BSH	30.000	0,300	19	28		h = 86	35	220	372
AMIN 12-030 GD	12.000	0,300	16	26	--	--	35	195	373
AMIN 15-030 GD	15.000	0,300	16	26	--	--	35	195	373
AMIN 12-030 GH	12.000	0,300	16	26	--	--	35	195	373
AMIN 15-070 GH2L	15.300	0,700	24	35	24	440	46	630	374
AMIN 19-100 GH	19.000	1,000	24	37	34	148	51	350	375
AMIN 19-100 GHK	19.000	1,000	24	44	--	--	51	245	375
AMIN 20-030 GD	20.000	0,300	16	26	--	--	35	195	376
AMIN 20-030 GH	20.000	0,300	16	26	--	--	35	195	376
AMIN 30-030 GD	30.000	0,300	14	16	--	--	36	190	377
AMIN 30-030 GH	30.000	0,300	14	16	--	--	36	190	377
AMIN 32-027 GD	32.000	0,270	13	20	23	35	29	210	378
AMIN 45-030 GD	45.000	0,300	14	16	--	--	36	190	379
AMIN 45-030 GH	45.000	0,300	14	16	--	--	36	190	379
AMIN 55-011 GD	55.000	0,110	9	14	--	--	20	125	380
AMIN 72-013 GD	72.000	0,130	10	15	--	--	29	165	381

Abrasive belt grinder – insulated

★★☆



Ordering example: A3993302113
 Length: approx. 325 mm
 Height: approx. 86 mm
 Weight: approx. 0,90 kg
 Drive: vane motor
 For more technical specifications see page 371

PG 15

Product number	Description	Valve	Idle speed min -1	Power consumption	Air consumption under load m³/min.	Belt peripheral speed m/s	Hose-nominal size mm		
A3993302113	AMIN 30 BSH	Lever	30.000	0,3	0,45	28	6	■	1

Included with the machine: an fromrasive belt mounting arm for long belts in dimension 13 x 305 mm, inlet and exhaust air hoses plus silencer, collet for 6 mm, spanner

Extra equipment: collets for Ø 3 mm, 4 mm, 5 mm, 1/8", 3/16", 1/4" Abrasive belt extensions in various sizes (lengths, widths and roll diameters) availfromle ex stock

Suited to LUKAS tools:
 Please take note of the relevant RPM stated on our packing material.

SBL, linishing belts

★★☆

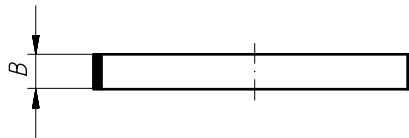

Ordering example: A3000130305040T01

Peripheral speed: 28 m/s
 NK = reg. Aluminium Oxide
 ZK = Zirconia Alum. Oxide

PG 8

Product number	Description	Grit	B mm	Length mm	Lining mm	recommended for Information on page 438		
A3000130305040T01	SBLT	ZK 40	13	305	robust-flexible	① ② ③ ④ ⑤ ⑧	■	100
A3000130305060T	SBLT	NK 60	13	305	robust-flexible	① ② ③ ④ ⑤ ⑥ ⑦ ⑧	■	100
A3000130305060T01	SBLT	ZK 60	13	305	robust-flexible	① ② ③ ④ ⑤ ⑧	■	100
A3000130305080T	SBLT	NK 80	13	305	robust-flexible	① ② ③ ④ ⑤ ⑥ ⑦ ⑧	■	100
A3000130305080T01	SBLT	ZK 80	13	305	robust-flexible	① ② ③ ④ ⑤ ⑧	■	100
A3000130305080X	SBLX	NK 80	13	305	robust	① ② ③ ④ ⑤ ⑥ ⑦ ⑧	■	100
A3000130305120T	SBLT	NK 120	13	305	robust-flexible	① ② ③ ④ ⑤ ⑥ ⑦ ⑧	■	100

Straight grinder – insulated

★★☆☆



Ordering example: A3993101112

Length: approx. 175 mm

Diameter: Ø 34,5 mm

Weight: approx. 0,90 kg

Drive: vane motor, integral speed regulator

For more technical specifications see page 371

PG 15

Product number	Description	Valve	Idle speed min -1	Power consumption	Air consumption under load	Collet dia Ø mm	Hose-nominal size mm		
A3993101112	AMIN 12-030 GD	Twist	12.000	0,3	0,49	6	8	■	1
A3993102112	AMIN 12-030 GH	Lever	12.000	0,3	0,49	6	8	■	1
A3993101115003	AMIN 15-030 GD	Twist	15.000	0,3	0,52	6	8	■	1

Included with the machine:

inlet and exhaust air hoses plus silencer, 6 mm collet and spanner

Extra equipment:

collets for Ø 3 mm, 4 mm, 5 mm, 1/8", 3/16", 1/4"

Suited to LUKAS tools: Please take note of the relevant RPM stated on our packing material.	Dimension	Page
AMIN 12-030 GD/GH		
Tungsten Carbide Burrs	up to Ø 20 mm	from 23
Burrs of HSS	up to Ø 8 mm	from 70
Mounted flap wheels SFV/M	Ø 40 mm	from 253
Mounted flap wheels SFI	Ø 30 mm	248
Mounted flap wheels SFA	Ø 15 mm, 20 mm, 30 mm	249
Abrasive Belts SBZY	up to Ø 30 mm	from 279
Abrasive Belts SBKE	up to Ø 36 mm	287
Abrasive Rolls SRZY/SRKE	up to Ø 20 mm	from 293
Abrasive Caps SK...	up to Ø 21 mm	from 299
Abrasive Sleeves SHKE	0885, 1385, 1885	307
Polishing Points P1	4020	from 133
Polishing Points P2	Ø 20 mm	from 136
Polishing Points P5	Ø 40 mm	from 148
AMIN 15-030 GD		
Tungsten Carbide Burrs	up to Ø 16 mm	from 23
Burrs of HSS	up to Ø 6 mm	from 70
Mounted flap wheels SFI	Ø 30 mm	248
Mounted flap wheels SFA	Ø 15 mm, 20 mm, 30 mm	249
Abrasive Belts SBZY	up to Ø 25 mm	from 279
Abrasive Belts SBKE	up to Ø 29 mm	287
Abrasive Rolls SRZY/SRKE	up to Ø 20 mm	from 293
Abrasive Caps SK...	up to Ø 16 mm	from 299
Abrasive Sleeves SHKE	0885, 1385	307

Straight grinder with spindle extension – insulated

★★☆



Ordering example: A3993102115002

Length: approx. 615 mm

Diameter: Ø 47 mm

Weight: approx. 2,1 kg

Drive: vane motor, integral speed regulator

(Dimension with l2mm + Lmm)

For more technical specifications see page 371

PG 15

Product number	Description	Valve	Idle speed min -1	Power consumption	Air consumption under load	Collet dia Ø mm	Hose-nominal size mm		
A3993102115002	AMIN 15-070 GH2L	Lever	15.300	0,7	0,7	6	10	■	1

Included with the machine:

inlet and exhaust air hoses plus silencer, two spindle extensions (each 200 mm long), collet 6 mm and spanner

Extra equipment:

spindle extension: 200 mm (max. length of spindle extensions up to 1.200 mm), collets for Ø 8 mm, 9 mm, 3/16", 1/4", 5/16



Suited to LUKAS tools: Please take note of the relevant RPM stated on our packing material.	Dimension	Page
Mounted flap wheels SFL/B/T/E/C	up to Ø 40 mm	from 236
Mounted flap wheels SFI	Ø 30 mm	248
Mounted flap wheels SFA	Ø 15 mm, 20 mm, 30 mm	249
Abrasive Belts SBZY	up to Ø 25 mm	from 279
Abrasive Belts SBKE	up to Ø 29 mm	287
Abrasive Rolls SRZY/SRKE	up to Ø 20 mm	from 293
Abrasive Caps SK...	up to Ø 16 mm	from 299
Abrasive Sleeves SHKE	0885, 1385	307
Polishing Points P1	Ø 32 mm	from 133
Polishing Points P2	Ø 16 mm	from 136

Straight grinder – insulated

★★☆☆



Ordering example: A3993102119

Length AMIN 19-100 GH: approx. 310 mm

Length AMIN 19-100 GHK: approx. 190 mm

Diameter: Ø 52 mm

Weight GH: approx. 2,3 kg

Weight GHK: approx. 1,7 kg Drive: van

Drive: vane motor, integral speed regulator

For more technical specifications see page 371

PG 15

Product number	Description	Valve	Idle speed min -1	Power consumption	Air consumption under load	Collet dia Ø mm	Hose-nominal size mm		
A3993102119	AMIN 19-100 GH	Lever	19.000	1	1	6	12	■	1
A3993102119001	AMIN 19-100 GHK	Lever	19.000	1	1	6	12	■	1

Included with the machine:

inlet and exhaust air hoses plus silencer, collet 6 mm and spanner

Extra equipment:

collets for Ø 8 mm, 9 mm, 3/16", 1/4", 5/16"

Suited to LUKAS tools: Please take note of the relevant RPM stated on our packing material.	Dimension	Page
Tungsten Carbide Burrs	up to Ø 12 mm	from 23
Burrs of HSS	up to Ø 4 mm	from 70
Mounted Points	up to Ø 50 mm	from 104
Polishing Points P1	up to Ø 50 mm	from 133
Polishing Points P2	up to Ø 12 mm	from 136
Polishing Points P3	up to Ø 10 mm	from 140
Polishing Points P5	up to Ø 50 mm	from 148
Polishing Points P6	up to Ø 16 mm	from 161
Abrasive Caps SK...	up to Ø 13 mm	from 299
Abrasive Rolls SR...	up to Ø 13 mm	from 293
Abrasive Belts SBZY	up to Ø 19 mm	from 279
Abrasive Belts SBKE	up to Ø 29 mm	287

Straight grinder – insulated

★★☆

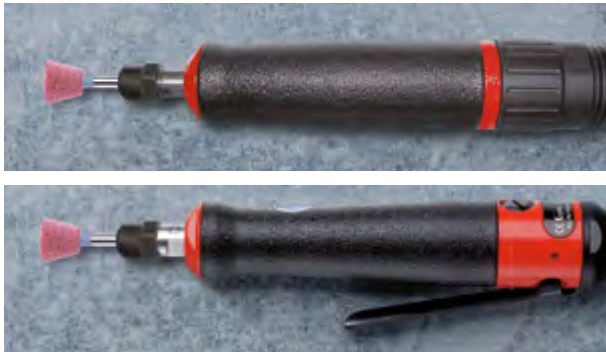

Ordering example: A3993101120
 Length: approx. 175 mm
 Diameter: Ø 34,5 mm
 Weight: approx. 0,90 kg
 Drive: vane motor, integral speed regulator
 For more technical specifications see page 371

PG 15

Product number	Description	Valve	Idle speed min -1	Power consumption	Air consumption under load	Collet dia Ø mm	Hose-nominal size mm		
A3993101120	AMIN 20-030 GD	Twist	20.000	0,3	0,53	6	8	■	1
A3993102120	AMIN 20-030 GH	Lever	20.000	0,3	0,45	6	8	■	1

Included with the machine:

inlet and exhaust air hoses plus silencer, collet 6 mm and spanner

Extra equipment:

collets for Ø 3 mm, 4 mm, 5 mm, 1/8", 3/16", 1/4"

Suited to LUKAS tools: Please take note of the relevant RPM stated on our packing material.	Dimension	Page
AMIN 20-030 GD/GH		
Tungsten Carbide Burrs	up to Ø 12 mm	from 23
Burrs of HSS	up to Ø 4 mm	from 70
Mounted flap wheels SFL	Ø 20 mm	from 236
Abrasive Belts SBZY	up to Ø 19 mm	from 279
Abrasive Belts SBKE	up to Ø 29 mm	287
Abrasive Rolls SRZY/SRKE	up to Ø 13 mm	from 293
Abrasive Caps SK...	up to Ø 13 mm	from 299
Abrasive Sleeves SHKE	0885	307
Mounted Points Shank 6 mm	Ø 22 mm, 25 mm, 32 mm, 40 mm	from 104
Polishing Points P2	Ø 13 mm	from 136

Straight grinder – insulated

★★☆☆



Ordering example: A3993101130

Length: approx. 175 mm

Diameter: Ø 34,5 mm

Weight: approx. 0,70 kg

Drive: vane motor, integral speed regulator

For more technical specifications see page 371

PG 15

Product number	Description	Valve	Idle speed min -1	Power consumption	Air consumption under load	Collet dia Ø mm	Hose-nominal size mm		
A3993101130	AMIN 30-030 GD	Twist	30.000	0,3	0,45	6	6	■	1
A3993102130	AMIN 30-030 GH	Lever	30.000	0,3	0,45	6	6	■	1

Included with the machine:

inlet and exhaust air hoses plus silencer, collet 6 mm and spanner

Extra equipment:

collets for Ø 3 mm, 3,25 mm, 4 mm, 5 mm, 1/8", 3/16", 1/4"

Suited to LUKAS tools: Please take note of the relevant RPM stated on our packing material.	Dimension	Page
Tungsten Carbide Burrs	up to Ø 8 mm	from 23
Burrs of HSS	up to Ø 3 mm	from 70
Mounted Points	up to Ø 32 mm	from 104
Polishing Points P1	up to Ø 32 mm	from 133
Polishing Points P2	up to Ø 10 mm	from 136
Polishing Points P3	up to Ø 10 mm	from 140
Polishing Points P5	up to Ø 32 mm	from 148
Polishing Points P6	up to Ø 12 mm	from 161
Abrasive Caps SK...	up to Ø 10 mm	from 299
Abrasive Belts SBZY	up to Ø 12 mm	from 279

Straight grinder, insulated

★★☆



Ordering example: A3993101132
 Length: approx. 206 mm
 Body diameter: approx. 30 mm
 Spindle approxing diameter: approx. 23mm
 Weight: approx. 0,40 kg
 Drive: vane motor
 Partial from exhaust (approxn be restricted)
 For more technical specifications see page 371

PG 15

Product number	Description	Valve	Idle speed min -1	Power consumption	Air consumption under load	Collet dia Ø mm	Hose-nominal size mm		
A3993101132	AMIN 32-027 GD	Twist	32.000	0,27	0,3	6	6	■	1

Included with the machine:

inlet and exhaust air hoses plus silencer, collet 6 mm and spanner

Extra equipment:

collets for Ø 3 mm, 1/8", 1/4"

Suited to LUKAS tools: Please take note of the relevant RPM stated on our packing material.	Dimension	Page
Tungsten Carbide Burrs	up to Ø 8 mm	from 23
Burrs of HSS	up to Ø 3 mm	from 70
Mounted Points	up to Ø 32 mm	from 104
Polishing Points P1	up to Ø 32 mm	from 133
Polishing Points P2	up to Ø 10 mm	from 136
Polishing Points P3	up to Ø 10 mm	from 140
Polishing Points P5	up to Ø 32 mm	from 148
Polishing Points P6	up to Ø 12 mm	from 161
Abrasive Caps SK...	up to Ø 10 mm	from 299
Abrasive Belts SBZY	up to Ø 12 mm	from 279

Straight grinder – insulated



Ordering example: A3993101145

Length: approx. 175 mm

Diameter: Ø 34,5 mm

Weight: approx. 0,70 kg

Drive: vane motor

For more technical specifications see page 371

PG 15

Product number	Description	Valve	Idle speed min -1	Power consumption	Air consumption under load	Collet dia Ø mm	Hose-nominal size mm		
A3993101145	AMIN 45-030 GD	Twist	45.000	0,3	0,5	6	6	■	1
A3993102145	AMIN 45-030 GH	Lever	45.000	0,3	0,5	6	6	■	1

Included with the machine:

inlet and exhaust air hoses plus silencer, collet 6 mm and spanner

Extra equipment:

collets for Ø 3 mm, 3,25 mm, 4 mm, 5 mm, 1/8", 3/16", 1/4"

Suited to LUKAS tools: Please take note of the relevant RPM stated on our packing material.	Dimension	Page
Tungsten Carbide Burrs	up to Ø 6 mm	from 23
Mounted Points	up to Ø 20 mm	from 104
Polishing Points P1	up to Ø 20 mm	from 133
Polishing Points P2	up to Ø 6 mm	from 136
Polishing Points P3	up to Ø 6 mm	from 140
Polishing Points P5	up to Ø 20 mm	from 148
Polishing Points P6	up to Ø 10 mm	from 161
Abrasive Caps SK...	up to Ø 5 mm	from 299
Abrasive Belts SBZY	up to Ø 12 mm	from 279

Straight grinder, insulated

★★☆



Ordering example: A3993101155

Length: approx. 130 mm

Diameter: Ø 16 mm

Weight: approx. 0,24 kg

Drive: vane motor

For more technical specifications see page 371

PG 15

Product number	Description	Valve	Idle speed min -1	Power consumption	Air consumption under load	Collet dia Ø mm	Hose-nominal size mm		
A3993101155	AMIN 55-011 GD	Twist	55.000	0,11	0,15	3	3	■	1

Included with the machine:

inlet and exhaust air hoses plus silencer, collet 3 mm and spanner

Extra equipment:

collets for Ø 2 mm, 3,25 mm, 1/8", 3/32"

Characteristics:

- Highest powered machine in its class
- Compact design
- Lock from rotary switch

Suited to LUKAS tools:	Dimension	Page
Please take note of the relevant RPM stated on our packing material.		
Tungsten Carbide Burrs	up to Ø 5 mm	from 23
Mounted Points	up to Ø 16 mm	from 104
Polishing Points P1	up to Ø 16 mm	from 133
Polishing Points P2	up to Ø 5 mm	from 136
Polishing Points P5	up to Ø 16 mm	from 148
Abrasive Caps SK...	up to Ø 5 mm	from 299
Abrasive Belts SBZY	up to Ø 10 mm	from 279

Straight grinder – insulated



Ordering example: A3993101172

Length: approx. 154 mm

Diameter: Ø 27,5 mm

Weight: approx. 0,45 kg

Drive: vane motor

For more technical specifications see page 371

PG 15

Product number	Description	Valve	Idle speed min -1	Power consumption	Air consumption under load	Collet dia Ø mm	Hose-nominal size mm		
A3993101172	AMIN 72-013 GD	Twist	72.000	0,13	0,21	3	5	■	1

Included with the machine:

inlet and exhaust air hoses plus silencer, collet 3 mm and spanner

Extra equipment:

collets for Ø 2 mm, 3,25 mm, 1/8", 3/32"

Suited to LUKAS tools:	Dimension	Page
Please take note of the relevant RPM stated on our packing material.		
Tungsten Carbide Burrs	up to Ø 4 mm	from 23
Mounted Points	up to Ø 13 mm	from 104
Polishing Points P1	up to Ø 13 mm	from 133
Polishing Points P2	up to Ø 4 mm	from 136
Polishing Points P5	up to Ø 13 mm	from 148

Conditioning machine

★★☆



Ordering example: A3995ESM1310

Weight: approx. 2,8 kg

PG 15

Product number	Description	Idle speed min -1	Power input W	Max. Ø mm tool diameter	Tool width mm	Hole size mm		
A3995ESM1310	ESM 1310 S	1.300-3.050	1.300	120	100	19	■	1

Satin finishing

- Conditioning
- Polishing
- Brushing
- Smoothing
- Deburring
- Matt finishing

Special features :

- Highly resilient motor (stable)
- Dual gear reduction (long service life)
- Dust-protected bearings (low wear)
- In conjunction with the optimal tooling, a shadow free and uniform surface can be achieved on metal, wood and plastic.

Electronic control:

- Soft start
- Infinitely variable speed control
- Temperature and overload cut-off

Suited to LUKAS tools: Please take note of the relevant RPM stated on our packing material.	Dimension	Page
Polishing Roll P6	100 x 50 mm, 100 x 100 mm	157
Grinding Rolls SBZY	100 x 100 mm	288
Flap Rolls LWL, LWW, LWMM, LWF	100 x 50 mm, 100 x 100 mm	from 271

CBN- and Diamond Tools for precision machining

384 Technical Information

387 CBN/Diamond Grinding Tools, vitrified bonded

393 CBN/Diamond Grinding Tools, electro-plated

Product line marking

The product lines are illustrated by star symbols at the top of the table; please refer to page **14** and **15**.

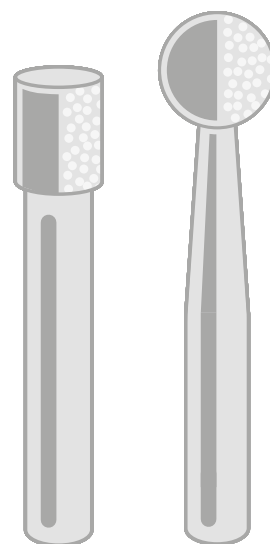

Technical Information

Allgemeines

The product group which includes CBN and diamond tools for precision machining is of ever increasing importance in relation to tools consisting of the usual grain types i.e. aluminium oxide and silicon carbide and their further developments e.g. zirconia, monocrystal and SOL-GEL (SG grain). These super hard grain types include natural and synthetic diamond in "D" and synthetic cubic boron nitride (CBN) "B".

Diamond is used for a wide range of hard materials (except steel), eg, carbides, oxides, nitrides and even diamond itself. Various types of plastic and rubber can also be economically machined.

Hardness

The ultrahard grain is considerably more expensive than conventional abrasive. Due to the extreme hardness, greater performance can be achieved when used in conjunction with modern manufacturing techniques; this can produce significant cost reductions.

Micro-Hardness – Temperature stability

The extreme differences in micro-hardness can be identified in the adjoining diagram.

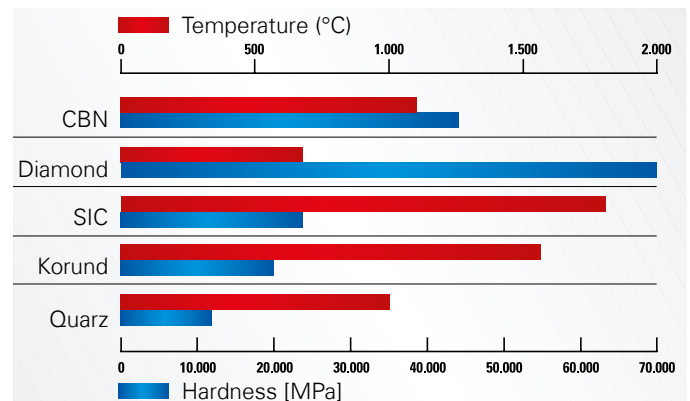

Technical Information

Bond

The following bondings are used in the manufacture of LUKAS CBN and diamond tools:

Vitrified bond

Due to the substantial layer of usable abrasive, vitrified bonded wheels give long tool life. They can be easily dressed and require little grinding pressure. These tools are manufactured in a variety of dimensions and in different structures. They must be used with coolant. They must be used with coolant.

Electro-Plated

Electro-plated bond provides a low cost tool. Electro-plating allows the manufacture of a large variety of profiles. They can be used wet or dry; coolant improves tool life.

Types of grain

Basically, we must differentiate between mono and polycrystalline types of grain. In the case of diamond, it must also be decided whether to use natural or synthetic types.

Many applications require a grain coating of nickel or titanium. The physical and chemical properties, including the shape of individual grit particles, are the decisive factors when selecting the most suitable grit type.

LUKAS vitrified bonded CBN-/diamond tools are identified by a quality code which contains all data determining the specification. The customer also receives this basic information regarding grit size and CBN-/diamond concentration.

Based on ISO 6106 and the corresponding FEPA standard, the grit sizes have been categorized as stated below.

Contrary to the grit size classification of conventional grain, cubic-boron nitride and diamond grain are specified based on the following: the smaller the number, the finer the grit – the larger the number, the coarser the grit. The prefix “B” specifies CBN, the prefix “D” denotes Diamond; the US equivalents in Standard Mesh are also shown below.

Grit Size based on ISO 6106 resp. FEPA and US-Standard

CBN	Diamond	Grit size μm	US-Standard Mesh
B 46	D 46	38 – 45	325/400
B 54	D 54	45 – 53	270/325
B 64	D 64	53 – 63	230/270
B 76	D 76	63 – 75	200/230
B 91	D 91	75 – 90	170/200
B 107	D 107	90 – 106	140/170
B 126	D 126	106 – 125	120/140
B 151	D 151	125 – 150	100/120
B 181	D 181	150 – 180	80/100
B 213	D 213	180 – 212	70/80
B 251	D 251	212 – 250	60/70

When selecting the grit size, it must be remembered that ultrahard abrasive grain gives a coarser surface finish than conventional grit types; this is due to the extremely low wear rate. The most widely used grit sizes lie between 54 and 91 microns.

CBN-/Diamond Grinding Tools, vitrified bonded

388 Technical Information

389 Special features of the vitrified bond

389 Selection of qualities

390 Selection of mounted point dimensions

390 Chart for tungsten carbide shanks

391 Selection of wheel dimension

Product line marking

The product lines are illustrated by star symbols at the top of the table; please refer to page **14** and **15**.

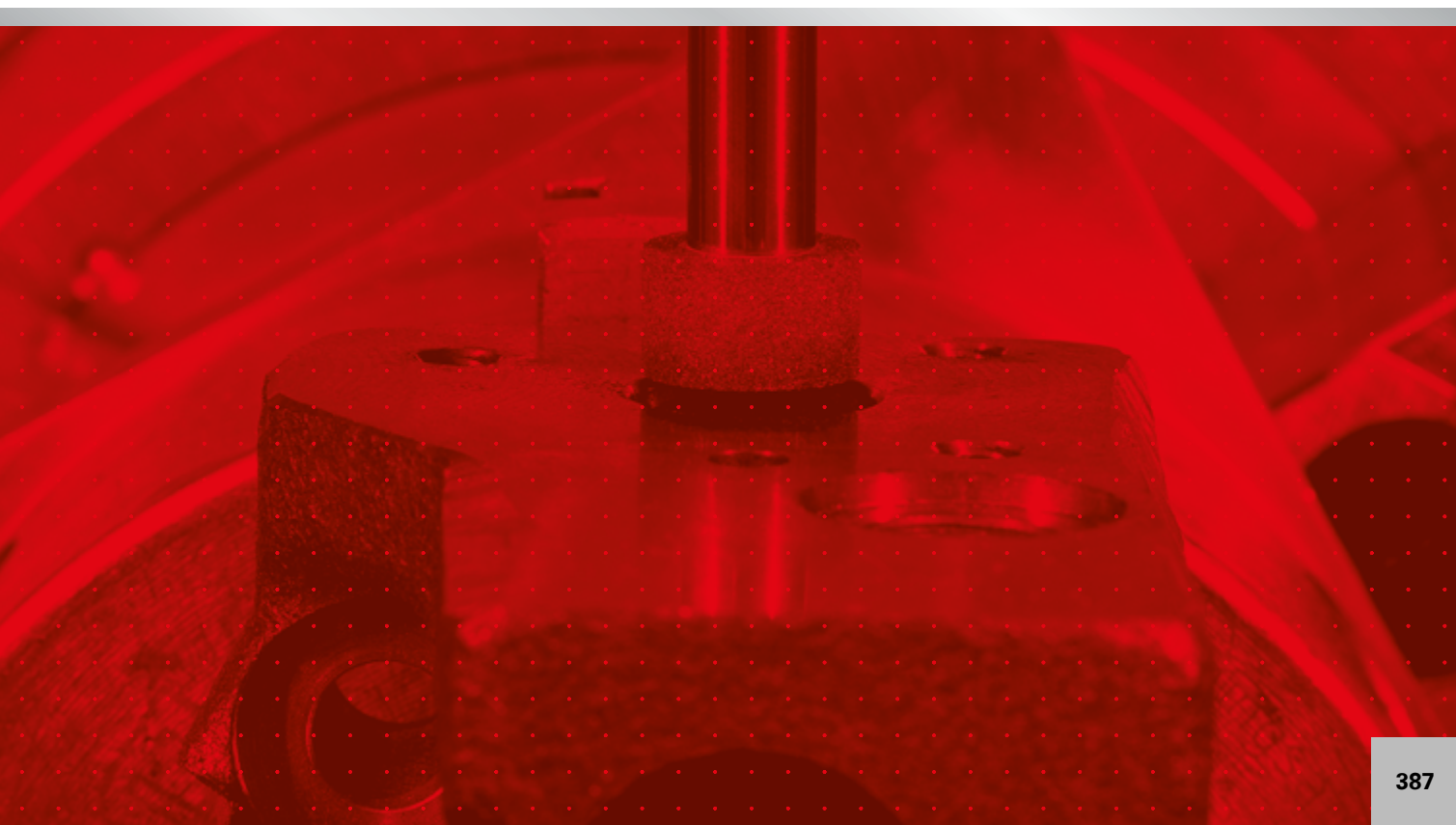
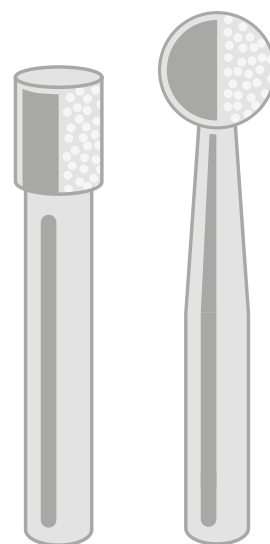

Technical Information

Shanks

The various types of CBN mounted points in a vitrified bond are, without exception, supplied with tungsten carbide shanks; carbide has a module of elasticity three times greater than steel.

The elasticity module denotes the extent to which a body deforms under pressure. Carbide has a high module of elasticity and therefore the deflection of the tools resulting from grinding pressure is kept to a minimum.

There are considerable advantages, eg:

- Reduction of spark-out time; this means a shorter grinding cycle
- Considerable improvement in tool life
- Reduction in tooling and setting costs
- Improvement in surface finish of the workpiece
- Improvement in workpiece geometry

The following table illustrates the rigidity of steel and tungsten carbide shank material in relation to diameter and overhang. A 3 mm diameter steel shank with an overhang of 40 mm is used as the base rigidity value of "1"

Dressing

There are two main reasons for dressing CBN/diamond tools:

1. To achieve geometrical accuracy.
2. To prevent dulling of the abrasive grain and to free the surface from loading, ie, to maintain a free-cutting tool.

These tools must be dressed wet with ample coolant!

Various dressing methods are used depending on the hardness of the tool. The softer wheel qualities can be dressed with either a single point diamond dresser, or a rotary silicon carbide/diamond wheel. Dressing infeeds are typically in the range of 0.2 mm. The single point diamond dresser cannot be used for the "medium hard" qualities. Dressing infeed is in the range of 50 – 200 µm. The harder specifications require dressing after only 50 – 500 workpieces depending on grinding parameters used. Dressing infeed is normally very small, ie, in the range of 2 to 10 microns. A rotary diamond wheel dresser is used.

Very hard qualities which require heavy dressing, need an additional dressing operation to "sharpen" the tool; a soft silicon carbide rotary dresser is used. The cutting speed should not exceed 10 m/s.

Relative rigidity of steel/tungsten carbide shank

Steel shank 3 mm x 40 mm overhang represents the base rigidity value "1"

overhang mm	shank							
	3		6		8		10	
	Steel	HM	Steel	HM	Steehl	HM	Steehl	HM
10	64	183	1024	2932	3237	9266	7900	22635
20	8	23	128	367	405	1159	988	2828
40	1	2,9	16	46	51	145	123	354

unstable very stable

Technical Information

Selection of Qualities/CBN/Diamond abrasive tools, vitrified bonded

LUKAS vitrified bonded diamond tools are identified by a quality code which contains all data determining the specification.

Please see below some typical specifications:

Quality code CBN	Grit	Concentration	Characteristic
53,5*	B 46	C 175	medium
29*	B 54	C 150	universal
34,5	B 54	C 170	
71,1	B 54	C 185	
50,3*	B 64	C 200	very hard
70,7	B 76	C 190	hard
57,7*	B 76	C 175	fine
54,8*	B 91	C 140	medium
70,1	B 91	C 185	hard
46,3*	B 151	C 175	medium

Quality code CBN	Grit	Concentration	Characteristic
15 D	D 91	C 120	
15,4 D	D 91	C 165	hard
18 D	D 151	C 120	

* = sehr erfolgreiche Qualitäten mit vielfältigen Einsatzgebieten

LFG-Bindung = Low Force Grinding

We can recommend a suitable quality following receipt of application details.

Special features of the vitrified bond

Concentration

The letter "C" in the specification represents the grit concentration; this can vary quite considerably depending on the application. The concentration denotes the volume of ultrahard abrasive grain used in the tool; this determines the grinding effectiveness and the price. The opposite table illustrates the range of concentration; the most popular are shown in bold figures.

Range of concentration

C	40	60	100	120	160	200	220
V*	100	150	250	300	400	500	550
Vol%	10	15	25	30	40	50	55

V* = Vol% x 10; this is also used to express concentration

Selection of mounted point dimensions

★★★

Ordering example: CBN-Mounted Point, Quality 50.3, D 11 mm, Shank 8 x 70
 * Shank length, please see below



PG 12

Diameter D	In Increments of	Width T	Shank options*/Diameter S
1,8–2,0 mm	0,1 mm	3 mm	2–3 mm
2,0–2,6 mm	0,1 mm	4 mm	2–3 mm
3,0–5,0 mm	0,1 mm	5 mm	2–5 mm
5,1–10,0 mm	0,1 mm	as D taken to nearest mm	4–10 mm
10,0–40,0 mm	1 mm	10 mm	4–12 mm

Selection of Tungsten carbide shanks

★★★

Ordering example: CBN-Mounted Point, Quality 50.3, D 11 mm, Shank 8 x 70
 Shanks can be re-used

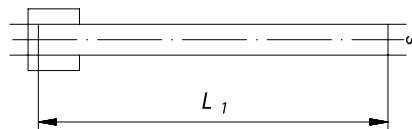

PG 12

Shank-diameter S	Shank length (blank length) L1 mm									
	30	40	50	60	70	80	100	120	130	150
2 mm	30	40	50							
2,5 mm	30	40	55							
3 mm	30	40	50	60						
4 mm		40	50	60	70					
5 mm			50	60	70	80	100	120		
6 mm			50	60	70	80	100	120		
8 mm			50	60	70	80	100	120		
10 mm				60	70	80	100	120	130	150
12 mm						80	100	120		150

Selection of wheel dimensions and shapes

★★★

Ordering example: CBN Wheel, Quality B 54 C 150 29, Type 3: D 35 x 10 mm, H 8 mm

Due to technical reasons, the smallest dimensions for W is 5 mm.

When ordering please specify bore size „H“

Minimum order quantity 10 pieces

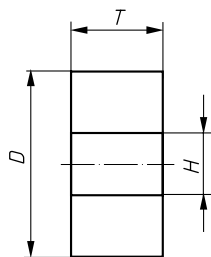

Type 1
unfinished (as fired)

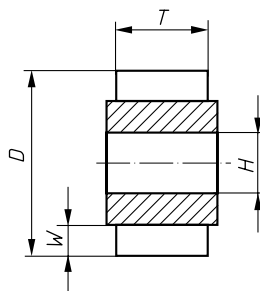

Type 2
plain steel core

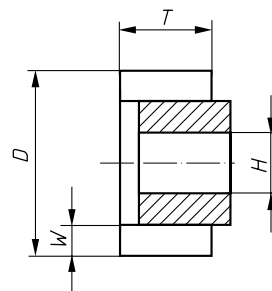

Type 3
steel core, 3 mm recessed

PG 12

Dimensions

Dimension D	In increments of D	Width		
14 to 25 mm	1 mm	10 mm	12 mm	15 mm
25 to 40 mm	5 mm	10 mm	12 mm	15 mm

CBN-/Diamond Mounted Points, electro-plated

394 CBN-/Diamond points, cylindrical shape

395 Diamond points using solid carbide

396 CBN-/Diamond points, spherical shape

369 Power tool

Product line marking

The product lines are illustrated by star symbols at the top of the table; please refer to page **14** and **15**.

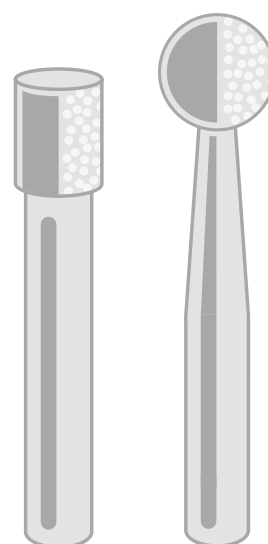

Diamond points cylindrical shape

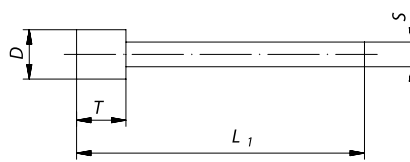

Ordering example: A34013050126

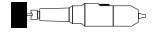

PG 13

Product number	Description	Grit size	D mm	T mm	S mm	L ₁ mm	Recommended for Information on page 438											
A34013050126	DS 01003	D 126	1	3	3	40	①	②	③	④	⑤	⑦	⑨	■	1			
A34013051126	DS 01503	D 126	1,5	3	3	40	①	②	③	④	⑤	⑦	⑨	■	1			
A34013052126	DS 02005	D 126	2	5	3	40	①	②	③	④	⑤	⑦	⑨	■	1			
A34013053126	DS 02505	D 126	2,5	5	3	40	①	②	③	④	⑤	⑦	⑨	■	1			
A34013054126	DS 03005	D 126	3	5	3	40	①	②	③	④	⑤	⑦	⑨	■	1			
A3401305412601	DS 03505	D 126	3,5	5	3	40	①	②	③	④	⑤	⑦	⑨	■	1			
A34013055126	DS 04005	D 126	4	5	3	40	①	②	③	④	⑤	⑦	⑨	■	1			
A3401305512601	DS 04505	D 126	4,5	5	3	40	①	②	③	④	⑤	⑦	⑨	■	1			
A34013056126	DS 05006	D 126	5	6	3	40	①	②	③	④	⑤	⑦	⑨	■	1			
A34013057126	DS 06007	D 126	6	7	3	40	①	②	③	④	⑤	⑦	⑨	■	1			
A34013058126	DS 08010	D 126	8	10	6	60	①	②	③	④	⑤	⑦	⑨	■	1			
A34013059126	DS 10010	D 126	10	10	6	60	①	②	③	④	⑤	⑦	⑨	■	1			
A34013060126	DS 12015	D 126	12	15	6	60	①	②	③	④	⑤	⑦	⑨	■	1			

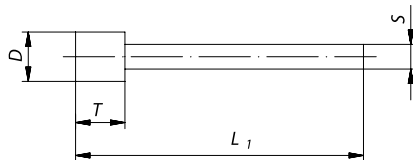
CBN points, cylindrical shape

Ordering example: A34033050126

PG 13

Product number	Description	Grit size	D mm	T mm	S mm	L ₁ mm	Recommended for										■	1			
							Information on page 438														
A34033050126	CS 01003	B 126	1	3	3	40		③	④						⑧						
A34033051126	CS 01503	B 126	1,5	3	3	40		③	④						⑧						
A34033052126	CS 02005	B 126	2	5	3	40		③	④						⑧						
A34033053126	CS 02505	B 126	2,5	5	3	40		③	④						⑧						
A34033054126	CS 03005	B 126	3	5	3	40		③	④						⑧						
A3403305412601	CS 03505	B 126	3,5	5	3	40		③	④						⑧						
A34033055126	CS 04005	B 126	4	5	3	40		③	④						⑧						
A3403305512601	CS 04505	B 126	4,5	5	3	40		③	④						⑧						
A34033056126	CS 05006	B 126	5	6	3	40		③	④						⑧						
A34033057126	CS 06007	B 126	6	7	3	40		③	④						⑧						
A34033058126	CS 08010	B 126	8	10	6	60		③	④						⑧						
A34033059126	CS 10010	B 126	10	10	6	60		③	④						⑧						
A34033060126	CS 12015	B 126	12	15	6	60		③	④						⑧						

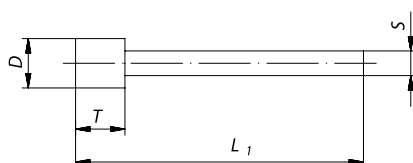
Diamond points using solid carbide shanks, cylindrical shape

Ordering example: A340202305126

This type in CBN quality available on request.



PG 13

Product number	Description	Grit size	D mm	T mm	S mm	L ₁ mm	Recommended for										■	1			
							Information on page 438														
A340202305126	DSH 02303	D 126	2,3	3	2	75	①	②	③	④	⑤		⑦		⑨						
A340203303126	DSH 03304	D 126	3,3	4	3	75	①	②	③	④	⑤		⑦		⑨						
A340204305126	DSH 04305	D 126	4,3	5	4	75	①	②	③	④	⑤		⑦		⑨						
A340206307126	DSH 06307	D 126	6,3	7	6	75	①	②	③	④	⑤		⑦		⑨						
A340208310126	DSH 08310	D 126	8,3	10	8	75	①	②	③	④	⑤		⑦		⑨						
A340210310126	DSH 10310	D 126	10,3	10	10	75	①	②	③	④	⑤		⑦		⑨						

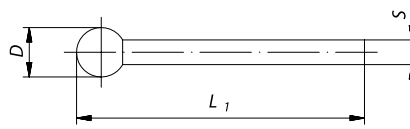
CBN points, spherical shape

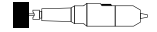

Ordering example: A34013090126



PG 13

Product number	Description	Grit size	D mm	S mm	L ₁ mm	Recommended for Information on page 438											
A34013090126	DSK 02020	D 126	2	3	40	①	②	③	④	⑤		⑦		⑨	■	1	
A34013091126	DSK 03030	D 126	3	3	40	①	②	③	④	⑤		⑦		⑨	■	1	
A34013092126	DSK 04040	D 126	4	3	40	①	②	③	④	⑤		⑦		⑨	■	1	
A34013093126	DSK 05050	D 126	5	3	40	①	②	③	④	⑤		⑦		⑨	■	1	
A34013094126	DSK 06060	D 126	6	3	40	①	②	③	④	⑤		⑦		⑨	■	1	
A34013095126	DSK 08080	D 126	8	6	60	①	②	③	④	⑤		⑦		⑨	■	1	

CBN points, spherical shape

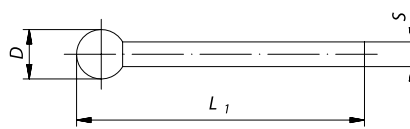

Ordering example: A34033090126



PG 13

Product number	Description	Grit size	D mm	S mm	L ₁ mm	Recommended for Information on page 438											
A34033090126	CSK 0202	B 126	2	3	40			③	④					⑧	■	1	
A34033091126	CSK 0303	B 126	3	3	40			③	④					⑧	■	1	
A34033092126	CSK 0404	B 126	4	3	40			③	④					⑧	■	1	
A34033093126	CSK 0505	B 126	5	3	40			③	④					⑧	■	1	
A34033094126	CSK 0606	B 126	6	3	40			③	④					⑧	■	1	
A34033095126	CSK 0808	B 126	8	6	60			③	④					⑧	■	1	

Diamond Files, electro-plated

398 Diamond files for off-hand filing machines

398 Diamond needle files

Product line marking

The product lines are illustrated by star symbols at the top of the table; please refer to page **14** and **15**.

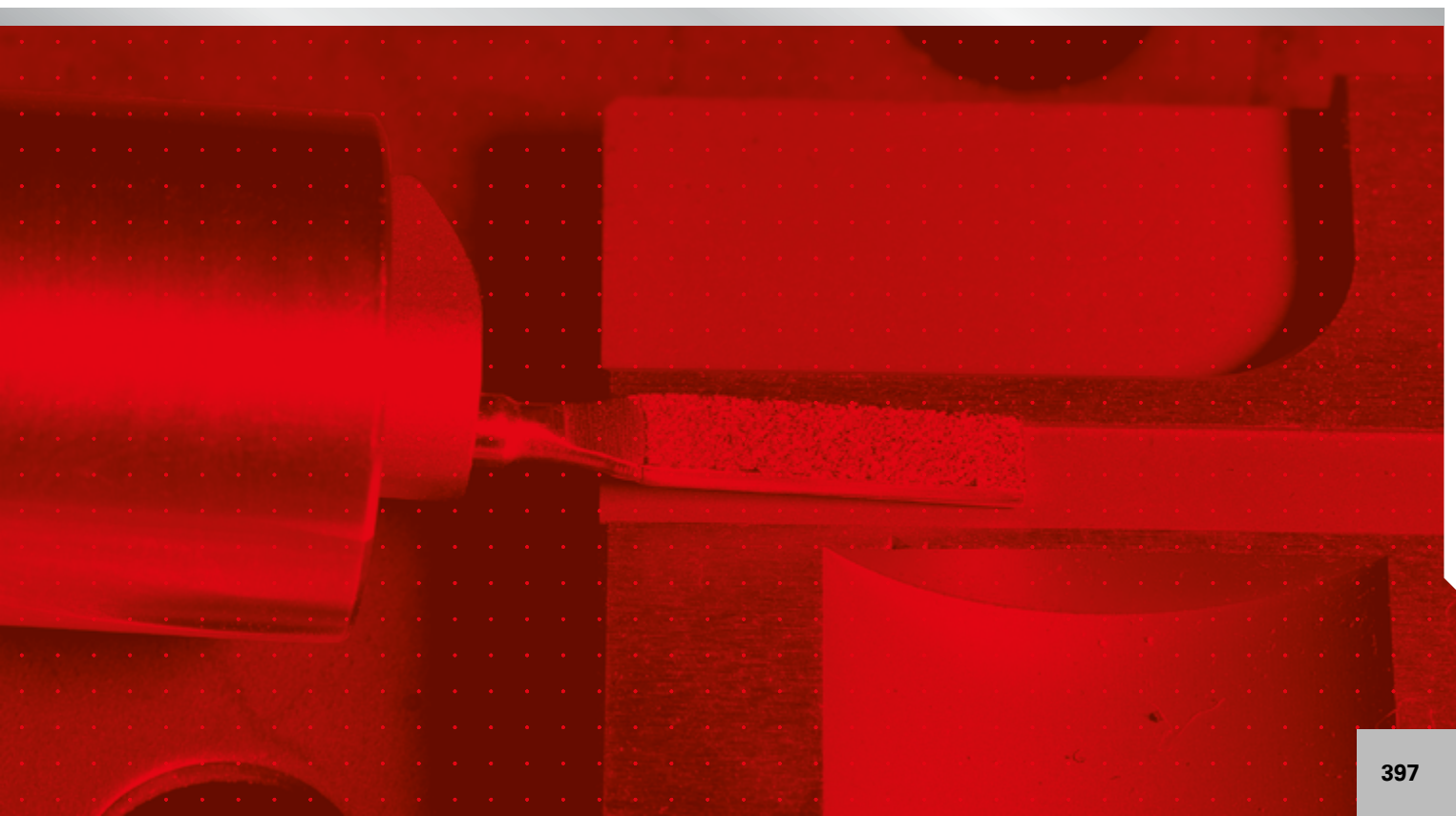

Diamond files for off-hand filing machines



Ordering example: A34003122126

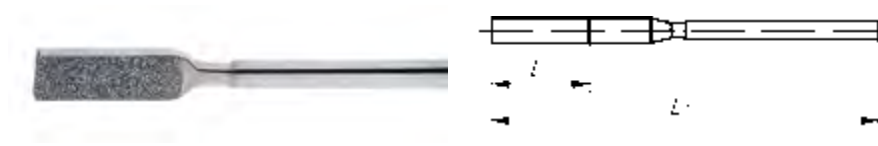
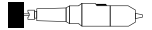

PG 13

Product number	Description	Shape	Shape	Grit size	Cross section mm	L ₂ mm	L ₁ mm	Recommended for												Information on page 438	Icon
								①	②	③	④	⑤	⑦	⑨							
A34003122126	DF 3122		flat	D 126	4 x 1	15	50	①	②	③	④	⑤	⑦	⑨	■	1					
A34003130126	DF 3130		round	D 126	4	15	50	①	②	③	④	⑤	⑦	⑨	■	1					

Diamond needle files



Ordering example: A34003140091



PG 13

Product number	Description	Shape	Shape	Grit size	Cross section mm	L ₂ mm	L ₁ mm	Recommended for												Information on page 438	Icon
								①	②	③	④	⑤	⑦	⑨							
A34003140091	DF 3140		flat	D 91	5,0 x 1,4	70	140	①	②	③	④	⑤	⑦	⑨	■	1					
A34003140126	DF 3140		flat	D 126	5,0 x 1,4	70	140	①	②	③	④	⑤	⑦	⑨	■	1					
A34003142091	DF 3142		triangular	D 91	3,5 x 3,5	70	140	①	②	③	④	⑤	⑦	⑨	■	1					
A34003142126	DF 3142		triangular	D 126	3,5 x 3,5	70	140	①	②	③	④	⑤	⑦	⑨	■	1					
A34003143126	DF 3143		square	D 126	2,5 x 2,5	70	140	①	②	③	④	⑤	⑦	⑨	■	1					
A34003144126	DF 3144		half-round	D 126	5,2 x 1,9	70	140	①	②	③	④	⑤	⑦	⑨	■	1					
A34003145126	DF 3145		round	D 126	3	70	140	①	②	③	④	⑤	⑦	⑨	■	1					
A34003146126	DF 3146		knife	D 126	5,0 x 1,4	70	140	①	②	③	④	⑤	⑦	⑨	■	1					

Product selection for retailers, assortments and accessories

401 Sales promotion and Product selection for retailers

418 Arbors for Felt Polishing Wheels

418 Mounting system for polishing wheels

419 Mounting arbors for small cutting-off wheels

419 Arbors for tools with internal thread

420 Adapter for SFI and SFA

420 Reducing bushes

421 Handstones

422 Tool-sets

Product line marking

The product lines are illustrated by star symbols at the top of the table; please refer to page **14** and **15**.

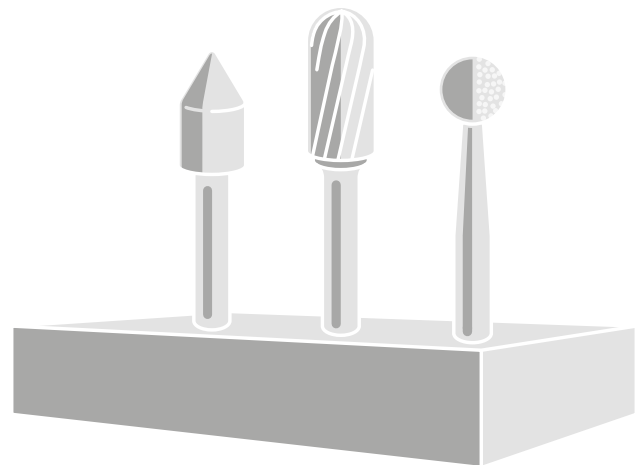

Your added value through sales promotion by LUKAS

As a specialised dealer, you are well aware of your customers' requests! That is why you also want to present and sell LUKAS products in a manner individually tailored to suit these customer

requests. Take advantage of Lukas presentation options to enhance your sales of industrial tools for cutting, milling, grinding or polishing on a sustainable level!



The Lukas display panel

Stable self-supporting presentation stand with perforated panel. Assemble your own individual display panel with hook hangers for Euro hole packaging, hook hangers for all products with a hole, a brochure pocket for further information or suspended shelves for carton packaging to create a consistent product presentation.

The POS cardboard counter display for cutting discs or mounted flap wheels

Rapidly assembled for your presentation of unique Lukas mounted flap wheels or cutting and grinding discs on your sales counter. Selectively available for tools with a diameter of 115 mm or 125 mm.

The POS counter display for tungsten carbide burrs

Lockable display for presentation and individual sale of valuable Lukas tungsten carbide burrs with a 3 mm or 6 mm shank. Suitable for your counter or sales shelves.

Attractive and informative individual packing

for the most popular Lukas tools, such as flap discs in the patented iQ-Series, tungsten carbide burrs, mounted flap wheels with shank made of abrasive cloth, abrasive fl eece or a combination and the mounted points assortment for steel or stainless steel, all individually packaged and with a Euro hole, is available for your individual "module" to exactly the same extent as cutting discs, diamond cutting discs, grinding discs or conventional flap discs (which we call lamellar flap discs) which are simply suspended by their hole.

Display panel

★★☆



Ordering example: A89403
Individual configuration

Product number	Description	Dimension														
A89403	Display panel	1 x 2,20 x 0,4 m													■	1

Stable self-supporting presentation stand with perforated panel

Accessories

- Hook hangers for Euro hole packaging
- Hook hangers for all products with a hole
- Suspended shelf
- Brochure pouch

Counter display

★★☆



Ordering example: A89406
Counter-display (without contents) for
10 cans of cutting disc sets

Product number	Description	Dimension														
A89406	Counter display	145 x 145 x 440 mm													■	1

Cutting disc set – PROGRESS



★★★

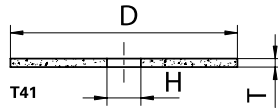

Ordering example: AT007231V9807010

T41 = flat

Iron, sulphur and chlorine (< 0,1 %)

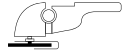
V_{max.}: 80 m/s

PG 7

Product number	Description	Quality	Ø D mm	T mm	H mm	n max. (1/min)	Recommended for Information on page 438		
AT007231V9807010	T41 115x1,0	A60Z-BF INOX	115	1,0	22,23	13.300	① ② ③ ④ ⑤ ⑥ ⑦	■	10
AT007233V9807010	T41 125x1,0	A60Z-BF INOX	125	1,0	22,23	12.200	① ② ③ ④ ⑤ ⑥ ⑦	■	10

Handy take-away pack for construction site

- in safety packaging
- moisture proof

Cutting disc set – PROMAX



★★★

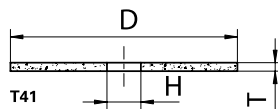

Ordering example: AT005841V9807010

T41 = flat

Iron, sulphur and chlorine (< 0,1 %)

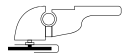
V_{max.}: 80 m/s

PG 7

Product number	Description	Quality	Ø D mm	T mm	H mm	n max. (1/min)	Recommended for Information on page 438		
AT005841V9807010	T41 115x1,0	A60X-BF INOX	115	1,0	22,23	13.300	① ② ③ ④ ⑤ ⑥ ⑦	■	10
AT005842V9807010	T41 125x1,0	A60X-BF INOX	125	1,0	22,23	12.200	① ② ③ ④ ⑤ ⑥ ⑦	■	10

Handy take-away pack for construction site

- in safety packaging
- moisture proof

Cutting disc set – PREMIUMFLEX

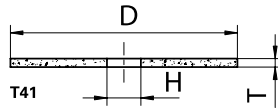

Ordering example: AT002672V9807010

T41 = flat

Iron, sulphur and chlorine

 $v_{max.}: 80 \text{ m/s}$

PG 7

Product number	Description	Quality	Ø D mm	T mm	H mm	n max. (1/min)	Recommended for Information on page 438		
AT004643V9807010	T41 115x1,0	A60S-BF INOX	115	1,0	22,23	13.300	① ② ③ ④ ⑤ ⑥ ⑦	■	10
AT002672V9807010	T41 125x1,0	A60S-BF INOX	125	1,0	22,23	12.200	① ② ③ ④ ⑤ ⑥ ⑦	■	10

Handy take-away pack for construction site

- in safety packaging
- moisture proof

Counter display, lockable



Ordering example: A5039004022

Product number	Description	Dimensionen	2 pieces each	Recommended for Information on page 438		
A5039004022	Counter display for tungsten carbide burrs	235 x 250 x 400 mm	HFA 0313.03 ZX, HFA 0820.06 ZX, HFA 1020.06 ZX, HFA 1225.06 ZX, HFC 0313.03 ZX, HFC 0820.06 ZX, HFC 1020.06 ZX, HFC 1225.06 ZX, HFD 0605.03 ZX, HFD 0807.06 ZX, HFD 1009.06 ZX, HFD 1210.06 ZX, HFG 0313.03 ZX, HFG 0820.06 ZX, HFG 1020.06 ZX, HFG 1225.06 ZX, HFM 0311.03 ZX, HFF 0820.06 ZX, HFF 1020.06 ZX, HFF 1225.06 ZX		▲	1

Product selection for retailers, burrs Z42

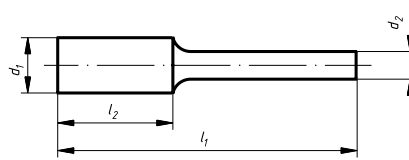

Ordering example: A10010820620F1



PG 1

Product number	Description	Cut	similar DIN 8033	d ₁ mm	l ₂ mm	d ₂ mm	Recommended for Information on page 438		
A10010820620F1	HFA 0820.06	Z42 Inox/Steel	ZYA 0820	8	20	6	① ② ③ ④	■	1
A10011225620F1	HFA 1225.06	Z42 Inox/Steel	ZYA 1225	12	25	6	① ② ③ ④	■	1
A10020820620F1	HFC 0820.06	Z42 Inox/Steel	WRC 0820	8	20	6	① ② ③ ④	■	1
A10021225620F1	HFC 1225.06	Z42 Inox/Steel	WRC 1225	12	25	6	① ② ③ ④	■	1
A10030605620F1	HFD 0605.06	Z42 Inox/Steel	KUD 0605	6	5	6	① ② ③ ④	■	1
A10030807620F1	HFD 0807.06	Z42 Inox/Steel	KUD 0807	8	7	6	① ② ③ ④	■	1
A10031210620F1	HFD 1210.06	Z42 Inox/Steel	KUD 1210	12	10	6	① ② ③ ④	■	1
A10100820620F1	HFF 0820.06	Z42 Inox/Steel	-	8	20	6	① ② ③ ④	■	1
A10101225620F1	HFF 1225.06	Z42 Inox/Steel	RBF 1225	12	25	6	① ② ③ ④	■	1
A10040820620F1	HFG 0820.06	Z42 Inox/Steel	SPG 0820	8	20	6	① ② ③ ④	■	1
A10041225620F1	HFG 1225.06	Z42 Inox/Steel	SPG 1225	12	25	6	① ② ③ ④	■	1

BASE-X product range for retailers

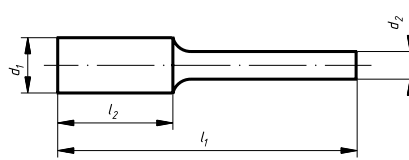

Ordering example: A10010313322F1

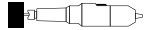

PG 1

Product number	Description	Cut	similar DIN 8033	d ₁ mm	l ₂ mm	d ₂ mm	l ₁ mm	Recommended for Information on page 438		
A10010313322F1	HFA 0313.03 ZX	ZX	ZYA 0313	3	13	3	40	① ② ③ ④ ⑤ ⑦	■	1
A10010820622F1	HFA 0820.06 ZX	ZX	ZYA 0820	8	20	6	60	① ② ③ ④ ⑤ ⑦	■	1
A10011225622F1	HFA 1225.06 ZX	ZX	ZYA 1225	12	25	6	65	① ② ③ ④ ⑤ ⑦	■	1
A10020313322F1	HFC 0313.03 ZX	ZX	WRC 0313	3	13	3	40	① ② ③ ④ ⑤ ⑦	■	1
A10020820622F1	HFC 0820.06 ZX	ZX	WRC 0820	8	20	6	60	① ② ③ ④ ⑤ ⑦	■	1
A10021225622F1	HFC 1225.06 ZX	ZX	WRC 1225	12	25	6	65	① ② ③ ④ ⑤ ⑦	■	1
A10030605322F1	HFD 0605.03 ZX	ZX	KUD 0605	6	5	3	35	① ② ③ ④ ⑤ ⑦	■	1
A10030807622F1	HFD 0807.06 ZX	ZX	KUD 0807	8	7	6	47	① ② ③ ④ ⑤ ⑦	■	1
A10031210622F1	HFD 1210.06 ZX	ZX	KUD 0313	12	10	6	51	① ② ③ ④ ⑤ ⑦	■	1
A10100820622F1	HFF 0820.06 ZX	ZX	-	8	20	6	60	① ② ③ ④ ⑤ ⑦	■	1
A10101225622F1	HFF 1225.06 ZX	ZX	RBf 1225	12	25	6	65	① ② ③ ④ ⑤ ⑦	■	1
A10040313322F1	HFG 0313.03 ZX	ZX	SPG 0313	3	13	3	40	① ② ③ ④ ⑤ ⑦	■	1
A10040820622F1	HFG 0820.06 ZX	ZX	SPG 0820	8	20	6	60	① ② ③ ④ ⑤ ⑦	■	1
A10041225622F1	HFG 1225.06 ZX	ZX	SPG 1225	12	25	6	65	① ② ③ ④ ⑤ ⑦	■	1
A10050311322F1	HFM 0311.03 ZX	ZX	SKM 0311	3	11	3	40	① ② ③ ④ ⑤ ⑦	■	1

Mounted point-Assortment - Ceramic



Ordering example: A20480005677F1



PG 3

Product number	Description	Shank diameter mm	Quality	Contents	1 piece each	Recommended for Information on page 438		
A20480005677F1	Assortment Ceramic	6	Ceramic	5-pieces	ZY 1020, ZY 1632, SP 1320, KU 1313. KE 1632	② ③ ④ ⑦	■	1

Mounted point-Assortment Inox



Ordering example: A20480004627WF1

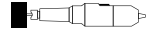

PG 3

Product number	Description	Shank diameter-mm	Quality	Contents	1 piece each	Recommended for Information on page 438		
A20480004627WF1	Assortment Inox	6	NK BA	4-pieces	ZY 1332.06 NK 24 N BA soft, ZY 2040.06 NK 24 N BA soft, ZY2 4006.06 NK 24 N BA soft, KU 2525.06 NKB/NK 24 R BA 98		■	1

Mounted point-Assortment Steel



Ordering example: A20480005602F1

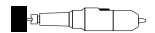

PG 3

Product number	Description	Shank diameter-mm	Quality	Contents	1 piece each	Recommended for Information on page 438		
A20480005602F1	Assortment Steel	6	EKR	5-pieces	ZY 1632.06 EKR 46 N V4, ZY 2525.06 EKR 36 N V4, WKS 2025.06 EKR 60 N V4, KU 2525.06, EKR 36 N V4, KE 1632.06, EKR 46 N V4		■	1

Mounted flap wheels of abrasive cloth

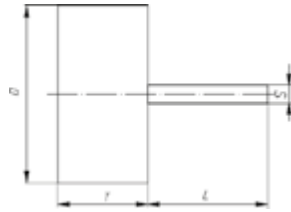

Ordering example: A2200030103060F1

NK = Reg. Aluminium Oxide

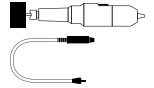

PG 14

Product number	Description	Grit	D mm	T mm	S mm	L mm	n recom. (1/min)	n max. (1/min)	Recommended for Information on page 438		
A2200030103060F1	SFL 03010.03	NK 60	30	10	3	40	16.000	18.000	① ② ③ ④ ⑤ ⑥ ⑦ ⑧	■	1
A2200030103080F1	SFL 03010.03	NK 80	30	10	3	40	16.000	18.000	① ② ③ ④ ⑤ ⑥ ⑦ ⑧	■	1
A2200030103120F1	SFL 03010.03	NK 120	30	10	3	40	16.000	18.000	① ② ③ ④ ⑤ ⑥ ⑦ ⑧	■	1
A2200040206060F1	SFL 04020.06	NK 60	40	20	6	40	12.000	19.100	① ② ③ ④ ⑤ ⑥ ⑦ ⑧	■	1
A2200040206080F1	SFL 04020.06	NK 80	40	20	6	40	12.000	19.100	① ② ③ ④ ⑤ ⑥ ⑦ ⑧	■	1
A2200040206120F1	SFL 04020.06	NK 120	40	20	6	40	12.000	19.100	① ② ③ ④ ⑤ ⑥ ⑦ ⑧	■	1
A2200060306040F1	SFL 06030.06	NK 40	60	30	6	40	8.000	12.700	① ② ③ ④ ⑤ ⑥ ⑦ ⑧	■	1
A2200060306060F1	SFL 06030.06	NK 60	60	30	6	40	8.000	12.700	① ② ③ ④ ⑤ ⑥ ⑦ ⑧	■	1
A2200060306080F1	SFL 06030.06	NK 80	60	30	6	40	8.000	12.700	① ② ③ ④ ⑤ ⑥ ⑦ ⑧	■	1
A2200060306120F1	SFL 06030.06	NK 120	60	30	6	40	8.000	12.700	① ② ③ ④ ⑤ ⑥ ⑦ ⑧	■	1

Mounted flap wheels of abrasive fleece

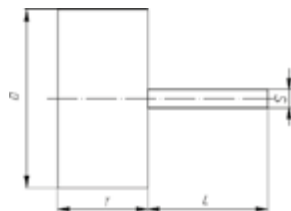

Ordering example: A2203040206104F1

A = Reg. Aluminium Oxide

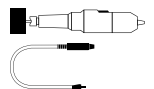

PG 14

Product number	Description	Grit	D mm	T mm	S mm	L mm	n recom. (1/min)	n max. (1/min)	Recommended for Information on page 438		
A2203040206104F1	SFV 04020.06	A 104	40	20	6	40	7.500	14.000	① ② ③ ④ ⑤ ⑥ ⑦ ⑧	■	1
A2203040206106F1	SFV 04020.06	A 106	40	20	6	40	7.500	14.000	① ② ③ ④ ⑤ ⑥ ⑦ ⑧	■	1
A2203060306104F1	SFV 06030.06	A 104	60	30	6	40	5.000	9.000	① ② ③ ④ ⑤ ⑥ ⑦ ⑧	■	1
A2203060306106F1	SFV 06030.06	A 106	60	30	6	40	5.000	9.000	① ② ③ ④ ⑤ ⑥ ⑦ ⑧	■	1

Flap wheels of abrasive fleece with abrasive cloth

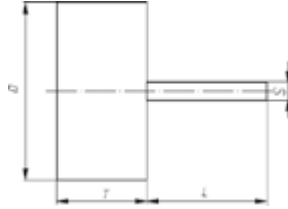

Ordering example: A2204040206104F1

A = Reg. Aluminium Oxide

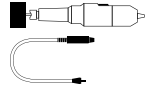

PG 14

Product number	Description	Grit	D mm	T mm	S mm	L mm	n recom. (1/min)	n max. (1/min)	Recommended for Information on page 438		
A2204040206104F1	SFM 04020.06	A 104/80	40	20	6	40	7.500	14.000	① ② ③ ④ ⑤ ⑥ ⑦ ⑧	■	1
A2204040206106F1	SFM 04020.06	A 106/150	40	20	6	40	7.500	14.000	① ② ③ ④ ⑤ ⑥ ⑦ ⑧	■	1
A2204060306104F1	SFM 06030.06	A 104/80	60	30	6	40	5.000	9.000	① ② ③ ④ ⑤ ⑥ ⑦ ⑧	■	1
A2204060306106F1	SFM 06030.06	A 106/150	60	30	6	40	5.000	9.000	① ② ③ ④ ⑤ ⑥ ⑦ ⑧	■	1

Purple Grain Single compact grinding disc

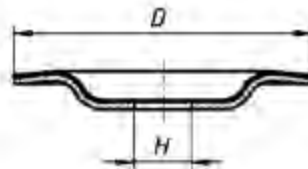

Ordering example: A27601150361547

v_{max.}: 80 m/s

Ceramic = Abrasive cloth ceramic grain



PG 5

Product number	Description	Grit	D mm	H mm	n max. (1/min)	Recommended for Information on page 438		
A27601150361547	PURPLE GRAIN SINGLE 115	Ceramic 36	115	22,23	13.300	① ② ③ ④ ⑤ ⑥ ⑦	■	10
A27601250361547	PURPLE GRAIN SINGLE 125	Ceramic 36	125	22,23	12.200	① ② ③ ④ ⑤ ⑥ ⑦	■	10

Purple Grain Single: The dynamic all-rounder with a long service life

Even with the use of very little force, "Purple Grain Single" achieves removal rates with a "wow" effect. The integrated backing pad made of environment-friendly recycled fibre guarantees a high degree of stability and durability. The innovative structure allows uniform wear and tear without overheating, embrittlement or eruptions. The deep offset zone allows you to work at a fl at angle. Thanks to its special tool geometry, the "Purple Grain Single" can also reach inaccessible areas, thus offering more possible applications than a conventional tool.

Purple Grain Multi compact grinding disc

★★★

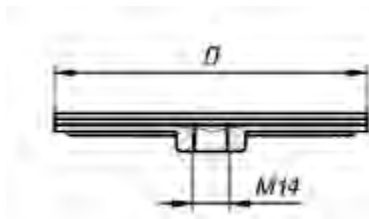

Ordering example: A27621150361547

 $v_{max.}$: 80 m/s

Ceramic = Abrasive cloth ceramic grain



PG 5

Product number	Description	Grit	D mm	Thread	n max. (1/min)	Recommended for Information on page 438		
A27621150361547	PURPLE GRAIN MULTI 115	Ceramic 36	115	M14	13.300	① ② ③ ④ ⑤ ⑥ ⑦	■	10
A27621250361547	PURPLE GRAIN MULTI 125	Ceramic 36	125	M14	12.200	① ② ③ ④ ⑤ ⑥ ⑦	■	10

Purple Grain Multi: Three times the removal rate!

With its unique multilayer design, the powerful "Purple Grain Multi" achieves maximum service life. The wear of the three grinding layers remains under control right up to the end. This is reflected in measurable cost savings compared with conventional tools. The integrated M14 threaded holder ensures superfast tool changes without an annoying clamping nut. With its flat tool geometry, the "Purple Grain Multi" achieves very good finishes, thus avoiding the need for reworking.

Lamellar Flap Discs, SLTT

★★★

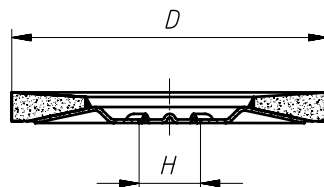

Ordering example: A27201150400045

 $v_{max.}$: 80 m/s

Z Power = Abrasive cloth using Zirconia Alum. Oxide with special coating containing active grinding additives

Ceramic = Abrasive cloth ceramic grain

ZK = Abrasive cloth with Zirconia Alum. Oxide

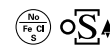

PG 5

Product number	Description	Grit	D mm	H mm	n max. (1/min)	Recommended for Information on page 438		
A27201150400045	SLTT 115	Z Power 40	115	22,23	13.300	① ② ③ ④	■	10
A27201150400050	SLTT 115	Ceramic 40	115	22,23	13.300	① ② ③ ④ ⑤ ⑥ ⑦ ⑧	■	10
A27201150400065	SLTT 115	ZK 40	115	22,23	13.300	① ② ③ ④ ⑤ ⑥ ⑦ ⑧	■	10
A27201150600045	SLTT 115	Z Power 60	115	22,23	13.300	① ② ③ ④	■	10
A27201150600050	SLTT 115	Ceramic 60	115	22,23	13.300	① ② ③ ④ ⑤ ⑥ ⑦ ⑧	■	10
A27201150600065	SLTT 115	ZK 60	115	22,23	13.300	① ② ③ ④ ⑤ ⑥ ⑦ ⑧	■	10
A27201250400045A	SLTT 125	Z Power 40	125	22,23	12.200	① ② ③ ④	■	10
A27201250400050A	SLTT 125	Ceramic 40	125	22,23	12.200	① ② ③ ④ ⑤ ⑥ ⑦ ⑧	■	10
A27201250400065A	SLTT 125	ZK 40	125	22,23	12.200	① ② ③ ④ ⑤ ⑥ ⑦ ⑧	■	10
A27201250600045	SLTT 125	Z Power 60	125	22,23	12.200	① ② ③ ④	■	10
A27201250600050	SLTT 125	Ceramic 60	125	22,23	12.200	① ② ③ ④ ⑤ ⑥ ⑦ ⑧	■	10
A27201250600065	SLTT 125	ZK 60	125	22,23	12.200	① ② ③ ④ ⑤ ⑥ ⑦ ⑧	■	10
A27201780400045	SLTT 178	Z Power 40	178	22,23	8.500	① ② ③ ④	■	10
A27201780400050	SLTT 178	Ceramic 40	178	22,23	8.500	① ② ③ ④ ⑤ ⑥ ⑦ ⑧	■	10

● Inox/Steel
 ● Steel
 ● Aluminium
 ● Stone
 ● Cast material
 ● Plastic
 ● Titanium

Lamellar Flap Discs, SLTT

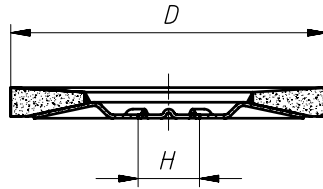

Ordering example: A27201150400045

$v_{max.}$: 80 m/s

Z Power = Abrasive cloth using Zirconia Alum. Oxide with special coating containing active grinding additives

Ceramic = Abrasive cloth ceramic grain

ZK = Abrasive cloth with Zirconia Alum. Oxide



PG 5

Product number	Description	Grit	D mm	H mm	n max. (1/min)	Recommended for Information on page 438		
A27201780400065	SLTT 178	ZK 40	178	22,23	8.500	① ② ③ ④ ⑤ ⑥ ⑦ ⑧	■	10
A27201780600045	SLTT 178	Z Power 60	178	22,23	8.500	① ② ③ ④	■	10
A27201780600050	SLTT 178	Ceramic 60	178	22,23	8.500	① ② ③ ④ ⑤ ⑥ ⑦ ⑧	■	10
A27201780600065	SLTT 178	ZK 60	178	22,23	8.500	① ② ③ ④ ⑤ ⑥ ⑦ ⑧	■	10

Please refer to page 204 for detailed information on the advantages of SLTT.

Lamellar Flap Discs, V2 Power

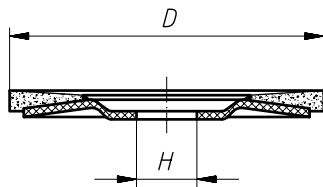

Ordering example: A27441150401445

$v_{max.}$: 80 m/s

Z Power = Abrasive cloth using Zirconia Alum. Oxide with special coating containing active grinding additives

Ceramic = Abrasive cloth ceramic grain

ZK = Abrasive cloth with Zirconia Alum. Oxide



PG 5

Product number	Description	Grit	D mm	H mm	n max. (1/min)	Recommended for Information on page 438		
A27441150401445	V2 POWER 115	Z Power 40	115	22,23	13.300	① ② ③ ④	■	10
A27441150401450	V2 POWER 115	Ceramic 40	115	22,23	13.300	① ② ③ ④ ⑤ ⑥ ⑦ ⑧	■	10
A27441150401465	V2 POWER 115	ZK 40	115	22,23	13.300	① ② ③ ④ ⑤ ⑥ ⑦ ⑧	■	10
A27441150601445	V2 POWER 115	Z Power 60	115	22,23	13.300	① ② ③ ④	■	10
A27441150601450	V2 POWER 115	Ceramic 60	115	22,23	13.300	① ② ③ ④ ⑤ ⑥ ⑦ ⑧	■	10
A27441150601465	V2 POWER 115	ZK 60	115	22,23	13.300	① ② ③ ④ ⑤ ⑥ ⑦ ⑧	■	10
A27441250401445	V2 POWER 125	Z Power 40	125	22,23	12.200	① ② ③ ④	■	10
A27441250401450	V2 POWER 125	Ceramic 40	125	22,23	12.200	① ② ③ ④ ⑤ ⑥ ⑦ ⑧	■	10
A27441250401465	V2 POWER 125	ZK 40	125	22,23	12.200	① ② ③ ④ ⑤ ⑥ ⑦ ⑧	■	10
A27441250601445	V2 POWER 125	Z Power 60	125	22,23	12.200	① ② ③ ④	■	10
A27441250601450	V2 POWER 125	Ceramic 60	125	22,23	12.200	① ② ③ ④ ⑤ ⑥ ⑦ ⑧	■	10
A27441250601465	V2 POWER 125	ZK 60	125	22,23	12.200	① ② ③ ④ ⑤ ⑥ ⑦ ⑧	■	10
A27441780401445	V2 POWER 178	Z Power 40	178	22,23	8.500	① ② ③ ④	■	10
A27441780401450	V2 POWER 178	Ceramic 40	178	22,23	8.500	① ② ③ ④ ⑤ ⑥ ⑦ ⑧	■	10
A27441780401465	V2 POWER 178	ZK 40	178	22,23	8.500	① ② ③ ④ ⑤ ⑥ ⑦ ⑧	■	10

Lamellar Flap Discs, V2 Power

★★★

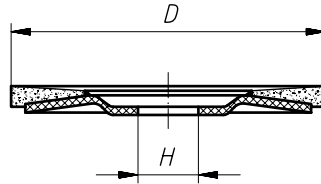

Ordering example: A27441150401445

 $v_{max.}: 80 \text{ m/s}$

Z Power = Abrasive cloth using Zirconia Alum. Oxide with special coating containing active grinding additives

Ceramic = Abrasive cloth ceramic grain

ZK = Abrasive cloth with Zirconia Alum. Oxide



PG 5

Product number	Description	Grit	D mm	H mm	n max. (1/min)	Recommended for Information on page 438		
A27441780601445	V2 POWER 178	Z Power 60	178	22,23	8.500	① ② ③ ④	■	10
A27441780601450	V2 POWER 178	Ceramic 60	178	22,23	8.500	① ② ③ ④ ⑤ ⑥ ⑦ ⑧	■	10
A27441780601465	V2 POWER 178	ZK 60	178	22,23	8.500	① ② ③ ④ ⑤ ⑥ ⑦ ⑧	■	10

Please refer to page 208 for detailed information on the advantages of V2 Power.

Lamellar Flap Discs V4 Master

★★★

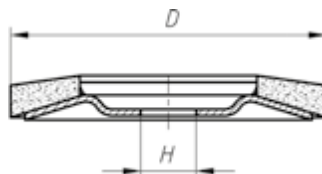

Ordering example: A27471250401465

 $v_{max.}: 80 \text{ m/s}$

ZK = Abrasive cloth with Zirconia Alum. Oxide



PG 5

Product number	Description	Grit	D mm	H mm	n max. (1/min)	Recommended for Information on page 438		
A27471150401465	V4 MASTER 115	ZK 40	115	22,23	13.300	① ② ③ ④ ⑥ ⑦	■	10
A27471150601465	V4 MASTER 115	ZK 60	115	22,23	13.300	① ② ③ ④ ⑥ ⑦	■	10
A27471250401465	V4 MASTER 125	ZK 40	125	22,23	12.200	① ② ③ ④ ⑥ ⑦	■	10
A27471250601465	V4 MASTER 125	ZK 60	125	22,23	12.200	① ② ③ ④ ⑥ ⑦	■	10
A27471780401465	V4 MASTER 178	ZK 40	178	22,23	8.500	① ② ③ ④ ⑥ ⑦	■	10

Properties

- extreme stock removal
- good edge retention
- deep recess around the bore
- long tool life
- low noise and low vibration
- ergonomically due to less effort
- iron-sulphur-chlorine free

SLTflex – for radii and fillet weldings



★★★

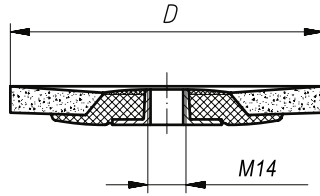

Ordering example: A272711504018

v_{max.}: 80 m/s

Ceramic = ceramic grain

ZKS = Zirconia Alum. Oxide with special coating containing active grinding additives



PG 5

Product number	Description	Grit	D mm	Thread	n max (1/min)	Recommended for Information on page 438		
A272711504018	SLTflex 115	ZKS 40	115	M14	13.300	① ② ③ ④ ⑤ ⑥ ⑦	■	10
A272711504070	SLTflex 115	Ceramic 40	115	M14	13.300	① ② ③ ④ ⑤ ⑥ ⑦	■	10
A272711506018	SLTflex 115	ZKS 60	115	M14	13.300	① ② ③ ④ ⑤ ⑥ ⑦	■	10
A272711506070	SLTflex 115	Ceramic 60	115	M14	13.300	① ② ③ ④ ⑤ ⑥ ⑦	■	10
A272712504018	SLTflex 125	ZKS 40	125	M14	12.200	① ② ③ ④ ⑤ ⑥ ⑦	■	10
A272712504070	SLTflex 125	Ceramic 40	125	M14	12.200	① ② ③ ④ ⑤ ⑥ ⑦	■	10
A272712506018	SLTflex 125	ZKS 60	125	M14	12.200	① ② ③ ④ ⑤ ⑥ ⑦	■	10
A272712506070	SLTflex 125	Ceramic 60	125	M14	12.200	① ② ③ ④ ⑤ ⑥ ⑦	■	10

SLTO/SLTR – competitively priced BASE-X reinforced fibre backing

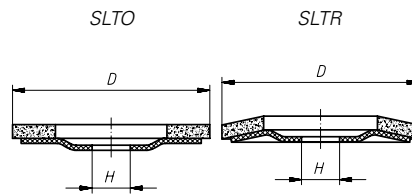

Ordering example: A27151000401501

 $v_{max.}: 80 \text{ m/s}$

ISO 15635

ZK = Zirconia Alum. Oxide

SLTO = flat

SLTR = dished

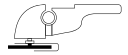

PG 6

Product number	Description	Grit	D mm	H mm	n max. (1/min)	Recommended for Information on page 438									
A27151000401501	SLTO 100 BASE-X	ZK 40	100	16	15.300	1	2	3	4	5	7			■	10
A27151000601501	SLTO 100 BASE-X	ZK 60	100	16	15.300	1	2	3	4	5	7			■	10
A27151000801501	SLTO 100 BASE-X	ZK 80	100	16	15.300	1	2	3	4	5	7			■	10
A27151001201501	SLTO 100 BASE-X	ZK 120	100	16	15.300	1	2	3	4	5	7			■	10
A27151150401501	SLTO 115 BASE-X	ZK 40	115	22,23	13.300	1	2	3	4	5	7			■	10
A27151150601501	SLTO 115 BASE-X	ZK 60	115	22,23	13.300	1	2	3	4	5	7			■	10
A27151150801501	SLTO 115 BASE-X	ZK 80	115	22,23	13.300	1	2	3	4	5	7			■	10
A27151151201501	SLTO 115 BASE-X	ZK 120	115	22,23	13.300	1	2	3	4	5	7			■	10
A27151250401501	SLTO 125 BASE-X	ZK 40	125	22,23	12.200	1	2	3	4	5	7			■	10
A27151250601501	SLTO 125 BASE-X	ZK 60	125	22,23	12.200	1	2	3	4	5	7			■	10
A27151250801501	SLTO 125 BASE-X	ZK 80	125	22,23	12.200	1	2	3	4	5	7			■	10
A27151780401501	SLTO 178 BASE-X	ZK 40	178	22,23	8.500	1	2	3	4	5	7			■	10
A27151780601501	SLTO 178 BASE-X	ZK 60	178	22,23	8.500	1	2	3	4	5	7			■	10
A27151780801501	SLTO 178 BASE-X	ZK 80	178	22,23	8.500	1	2	3	4	5	7			■	10
A27181000401501	SLTR 100 BASE-X	ZK 40	100	16	15.300	1	2	3	4	5	7			■	10
A27181000601501	SLTR 100 BASE-X	ZK 60	100	16	15.300	1	2	3	4	5	7			■	10
A27181000801501	SLTR 100 BASE-X	ZK 80	100	16	15.300	1	2	3	4	5	7			■	10
A27181001201501	SLTR 100 BASE-X	ZK 120	100	16	15.300	1	2	3	4	5	7			■	10
A27181150401501	SLTR 115 BASE-X	ZK 40	115	22,23	13.300	1	2	3	4	5	7			■	10
A27181150601501	SLTR 115 BASE-X	ZK 60	115	22,23	13.300	1	2	3	4	5	7			■	10
A27181150801501	SLTR 115 BASE-X	ZK 80	115	22,23	13.300	1	2	3	4	5	7			■	10
A27181151001501	SLTR 115 BASE-X	ZK 100	115	22,23	13.300	1	2	3	4	5	7			■	10
A27181250401501	SLTR 125 BASE-X	ZK 40	125	22,23	12.200	1	2	3	4	5	7			■	10
A27181250601501	SLTR 125 BASE-X	ZK 60	125	22,23	12.200	1	2	3	4	5	7			■	10
A27181250801501	SLTR 125 BASE-X	ZK 80	125	22,23	12.200	1	2	3	4	5	7			■	10
A27181780401501	SLTR 178 BASE-X	ZK 40	178	22,23	8.500	1	2	3	4	5	7			■	10
A27181780601501	SLTR 178 BASE-X	ZK 60	178	22,23	8.500	1	2	3	4	5	7			■	10
A27181780801501	SLTR 178 BASE-X	ZK 80	178	22,23	8.500	1	2	3	4	5	7			■	10
A27181781201501	SLTR 178 BASE-X	ZK 120	178	22,23	8.500	1	2	3	4	5	7			■	10

Cutting discs for stainless steel – PROGRESS



★★★

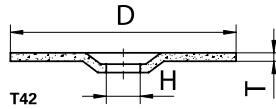
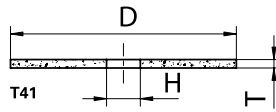

Ordering example: AT007226V9802

T41 = flat

T42 = depressed centre

Iron, sulphur and chlorine free

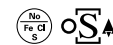
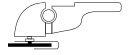
v_{max.}: 80 m/s

PG 7

Product number	Description	Quality	Ø D mm	T mm	Ø H mm	n max. (1/min)	Recommended for Information on page 438		
AT007226V9802	T41 100x1,0	A60Z-BF Inox	100	1,0	16,00	15.300	① ② ③ ④ ⑤ ⑥ ⑦	■	50
AT007231V9802	T41 115x1,0	A60Z-BF Inox	115	1,0	22,23	13.300	① ② ③ ④ ⑤ ⑥ ⑦	■	50
AT007235V9802	T41 115x1,6	A46Z-BF Inox	115	1,6	22,23	13.300	① ② ③ ④ ⑤ ⑥ ⑦	■	50
AT007211V9802	T41 115x2,5	A30Z-BF Inox	115	2,5	22,23	13.300	① ② ③ ④ ⑤ ⑥ ⑦	■	25
AT007233V9802	T41 125x1,0	A60Z-BF Inox	125	1,0	22,23	12.200	① ② ③ ④ ⑤ ⑥ ⑦	■	50
AT007237V9802	T41 125x1,6	A46Z-BF Inox	125	1,6	22,23	12.200	① ② ③ ④ ⑤ ⑥ ⑦	■	50
AT007213V9802	T41 125x2,5	A30Z-BF Inox	125	2,5	22,23	12.200	① ② ③ ④ ⑤ ⑥ ⑦	■	25
AT007239V9802	T41 150x1,2	A60Z-BF Inox	150	1,2	22,23	10.200	① ② ③ ④ ⑤ ⑥ ⑦	■	50
AT007241V9802	T41 150x1,6	A46Z-BF Inox	150	1,6	22,23	10.200	① ② ③ ④ ⑤ ⑥ ⑦	■	25
AT007243V9802	T41 180x1,6	A46Z-BF Inox	180	1,6	22,23	8.500	① ② ③ ④ ⑤ ⑥ ⑦	■	25
AT007245V9802	T41 230x2,0	A46Z-BF Inox	230	2,0	22,23	6.600	① ② ③ ④ ⑤ ⑥ ⑦	■	25
AT007219V9802	T41 230x2,5	A30Z-BF Inox	230	2,5	22,23	6.600	① ② ③ ④ ⑤ ⑥ ⑦	■	25
AT005301V9802	T42 115x0,8	A60Z-BF Inox	115	0,8	22,23	13.300	① ② ③ ④ ⑤ ⑥ ⑦	■	50
AT007212V9802	T42 115x2,5	A30Z-BF Inox	115	2,5	22,23	13.300	① ② ③ ④ ⑤ ⑥ ⑦	■	25
AT005302V9802	T42 125x0,8	A60Z-BF Inox	125	0,8	22,23	12.200	① ② ③ ④ ⑤ ⑥ ⑦	■	50
AT007214V9802	T42 125x2,5	A30Z-BF Inox	125	2,5	22,23	12.200	① ② ③ ④ ⑤ ⑥ ⑦	■	25
AT007244V9802	T42 180x1,6	A46Z-BF Inox	180	1,6	22,23	8.500	① ② ③ ④ ⑤ ⑥ ⑦	■	25
AT007220V9802	T42 230x2,5	A30Z-BF Inox	230	2,5	22,23	6.600	① ② ③ ④ ⑤ ⑥ ⑦	■	25

Cutting discs for stainless steel – PREMIUMFLEX

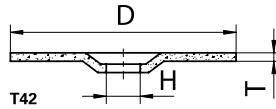
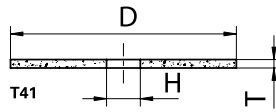

Ordering example: AT003108V9802

T41 = flat

T42 = depressed centre

Iron, sulphur and chlorine free

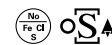
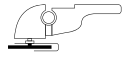
 $v_{max.}: 80 \text{ m/s}$

PG 7

Product number	Description	Quality	Ø D mm	T mm	Ø H mm	n max. (1/min)	Recommended for Information on page 438		
AT003108V9802	T41 100x1,0	A60S-BF Inox	100	1,0	16,00	15.300	1 2 3 4 5 6 7	■	50
AT004643V9802	T41 115x1,0	A60S-BF Inox	115	1,0	22,23	13.300	1 2 3 4 5 6 7	■	50
AT000647V9802	T41 115x1,6	A46T-BF Inox	115	1,6	22,23	13.300	1 2 3 4 5 6 7	■	50
AT002672V9802	T41 125x1,0	A60S-BF Inox	125	1,0	22,23	12.200	1 2 3 4 5 6 7	■	50
AT000674V9802	T41 125x1,6	A46T-BF Inox	125	1,6	22,23	12.200	1 2 3 4 5 6 7	■	50
AT000700V9802	T41 150x1,6	A46T-BF Inox	150	1,6	22,23	10.200	1 2 3 4 5 6 7	■	25
AT000716V9802	T41 180x1,6	A46T-BF Inox	180	1,6	22,23	8.500	1 2 3 4 5 6 7	■	25
AT000742V9802	T41 230x1,9	A46T-BF Inox	230	1,9	22,23	6.600	1 2 3 4 5 6 7	■	25
AT003568V9802	T41 230x2,5	A24/30S-BF Inox	230	2,5	22,23	6.600	1 2 3 4 5 6 7	■	25
AT001442V9802	T42 115x2,5	A24/30S-BF Inox	115	2,5	22,23	13.300	1 2 3 4 5 6 7	■	25
AT004157V9802	T42 125x2,5	A24/30S-BF Inox	125	2,5	22,23	12.200	1 2 3 4 5 6 7	■	25
AT000718V9802	T42 180x1,6	A46T-BF Inox	180	1,6	22,23	8.500	1 2 3 4 5 6 7	■	25
AT000744V9802	T42 230x1,9	A46T-BF Inox	230	1,9	22,23	6.600	1 2 3 4 5 6 7	■	25
AT005451V9802	T42 230x2,5	A24/30S-BF Inox	230	2,5	22,23	6.600	1 2 3 4 5 6 7	■	25
AT004168V9802	T42 230x3,0	A24/30S-BF Inox	230	3,0	22,23	6.600	1 2 3 4 5 6 7	■	25

Cutting discs for metal – PREMIUMFLEX

★☆☆

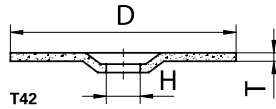
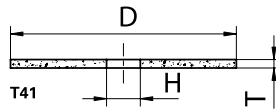

Ordering example: AT006440V9802

T41 = flat

T42 = depressed centre

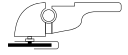
v_{max.}: 80 m/s

PG 7

Product number	Description	Quality	Ø D mm	T mm	Ø H mm	n max. (1/min)	Recommended for Information on page 438							
AT006440V9802	T41 115x1,0	A60S-BF Steel	115	1,0	22,23	13.300	1	2	3	5			■	50
AT000648V9802	T41 115x1,6	A46T-BF Steel	115	1,6	22,23	13.300	1	2	3	5			■	50
AT000656V9802	T41 115x2,5	A24R-BF Steel	115	2,5	22,23	13.300	1	2	3	5			■	25
AT006710V9802	T41 125x1,0	A60S-BF Steel	125	1,0	22,23	12.200	1	2	3	5			■	50
AT000675V9802	T41 125x1,6	A46T-BF Steel	125	1,6	22,23	12.200	1	2	3	5			■	50
AT000679V9802	T41 125x2,5	A24R-BF Steel	125	2,5	22,23	12.200	1	2	3	5			■	25
AT000707V9802	T41 150x2,5	A24R-BF Steel	150	2,5	22,23	10.200	1	2	3	5			■	25
AT000717V9802	T41 180x1,6	A46T-BF Steel	180	1,6	22,23	8.500	1	2	3	5			■	25
AT000728V9802	T41 180x3,0	A24R-BF Steel	180	3,0	22,23	8.500	1	2	3	5			■	25
AT000743V9802	T41 230x1,9	A46T-BF Steel	230	1,9	22,23	6.600	1	2	3	5			■	25
AT000967V9802	T41 230x2,0	A36T-BF Steel	230	2,0	22,23	6.600	1	2	3	5			■	25
AT000750V9802	T41 230x3,0	A24R-BF Steel	230	3,0	22,23	6.600	1	2	3	5			■	25
AT000638V9802	T42 100x3,0	A24R-BF Steel	100	3,0	16	15.300	1	2	3	5			■	25
AT000662V9802	T42 115x2,5	A24R-BF Steel	115	2,5	22,23	13.300	1	2	3	5			■	25
AT000688V9802	T42 125x2,5	A24R-BF Steel	125	2,5	22,23	15300	1	2	3	5			■	25
AT000732V9802	T42 180x3,0	A24R-BF Steel	180	3,0	22,23	8.500	1	2	3	5			■	25
AT000745V9802	T42 230x1,9	A46T-BF Steel	230	1,9	22,23	6.600	1	2	3	5			■	25
AT000754V9802	T42 230x3,0	A24R-BF Steel	230	3,0	22,23	6.600	1	2	3	5			■	25

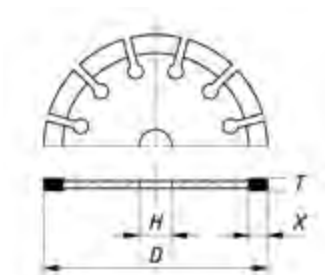
Blue Cut S10, the popular disc for construction sites

Ordering example: A345241151110085

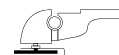
 v_{max} : 80 m/s

PG 7

Product number	Description	D mm	Height of segments X mm	Width of segments T mm	H mm	n max. (1/min)	Recommended for	Information on page 438					
A345241151110085	Blue Cut S10	115	10	2,0	22,23	13.300	⑩ ⑪					■	1
A345241251110095	Blue Cut S10	125	10	2,0	22,23	12.200	⑩ ⑪					■	1
A345241801110145	Blue Cut S10	180	10	2,4	22,23	8.500	⑩ ⑪					■	1
A345242301110165	Blue Cut S10	230	10	2,5	22,23	6.600	⑩ ⑪					■	1

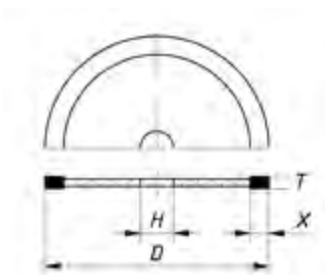
Please see page 341–352 for further products.

FC7, the cost-effective tile cutting disc

Ordering example: A345211151107015

 v_{max} : 80 m/s

PG 7

Product number	Description	D mm	Height of segments X mm	Width of segments T mm	H mm	n max. (1/min)	Recommended for	Information on page 438					
A345211151107015	FC7	115	7	1,8	22,23	13.300	⑫					■	1
A345211251107015	FC7	125	7	2,0	22,23	12.200	⑫					■	1
A345212301107015	FC7	230	7	2,5	22,23	6.600	⑫					■	1

Please see page 341–352 for further products.

Arbors for Felt Polishing Wheels

★★☆

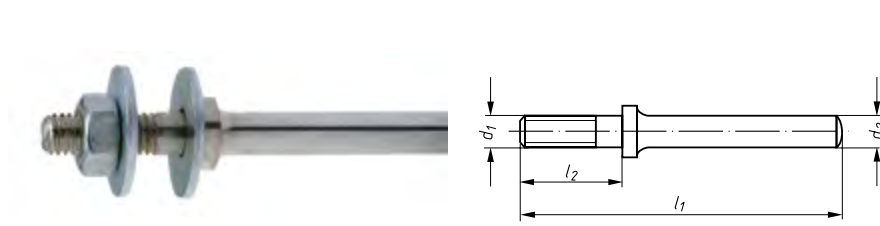

Ordering example: A1630780

The delivery includes for each stud

- 2 washers Ø 18 mm
- 2 washers Ø 30 mm
- 1 hex nut



PG 7

Product number	Description	d ₁ mm	l ₂ mm	d ₂ mm	l ₁ mm	n max. (1/min)	Recommended for Information on page 438		
A1630780	ASB 780	M6	20	6	63	7.000			■ 5
A1630781	ASB 781	M6	30	6	73	7.000			■ 5

Mounting system for polishing wheels

★★☆



Ordering example: A6981008000



PG 7

Product number	Description	Recommended for Information on page 438		
A6981008000	Mounting system MCA+ K25 H		■	1

The mounting system for polishing wheels consists of a plastic sleeve (MCA) and a mounting arbor with 8 mm diameter shaft (K25) which is solely applicable to shape SE1 in the dimensions 10010 B 25 and 10020 B 25. It is not permitted to use this mounting system for polishing wheels with larger diameters. Maximum peripheral wheel speed using this mounting method is 10m/s; this means a maximum spindle speed of 1900 R.P.M. with a wheel diameter of 100 mm.

Mounting arbors for small cutting-off wheels and grinding discs

★★☆☆

Ordering example: A36600060604



PG 7

Product number	Description	Tools' internal diameter mm	Lo	d ₂ mm	Recommended for Information on page 438		
A36600060604	ASB 6/6	6	0-4	6		■	1
A36600061004	ASB 6/1	10	0-4	6		■	1
A36600081048	ASB 8/10	10	4-8	8		■	1

Arbors for tools with internal thread

★★☆☆

Ordering example: A16303422

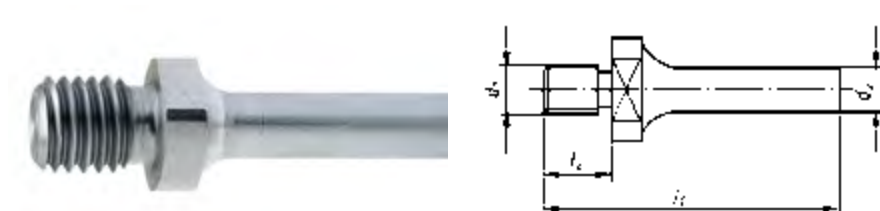

PG 7

Product number	Description	d ₁ mm	l ₂ mm	d ₂ mm	l ₁ mm	Recommended for Information on page 438		
A16303422	ASB 342 B	M 10	12	6	52		■	5
A16303423	ASB 342 C	M 12	14	6	54		■	5
A16303424	ASB 342 D	M 8	10	6	50		■	5
A16303442	ASB 344 B	M 10	12	8	52		■	5
A16303443	ASB 344 C	M 12	14	8	54		■	5
A16303452	ASB 345 B	M 10	12	10	52		■	5

Adaptor for SFI

★★☆

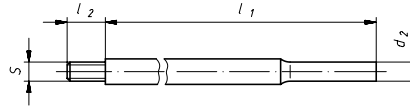

Ordering example: A36300404

Used only for mounted flap wheels page 248.

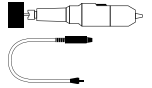

PG 8

Product number	Description	d ₂ mm	l ₁ mm	S mm	l ₂ mm	Recommended for Information on page 438		
A36300404	WADI 0404	6	80	M4	4		■	1
A36300407	WADI 0407	6	80	M4	7		■	1
A36300609	WADI 0609	6	100	M6	9		■	1
A36300612	WADI 0612	6	100	M6	12		■	1

Adaptor for SFA

★★☆

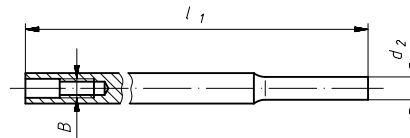

Ordering example: A36300518

Used only for mounted flap wheels page 249.

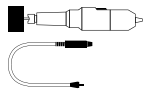

PG 8

Product number	Description	d ₂ mm	l ₁ mm	B mm	Recommended for Information on page 438		
A36300518	WADA 05	6	100	M5		■	1

Reducing bush

★★☆

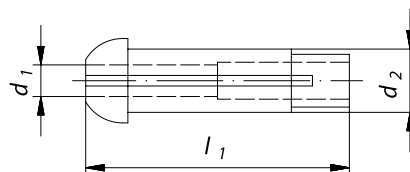

Ordering example: A3630006



PG 8

Product number	Description	d ₁ mm	d ₂ mm	l ₁ mm	Recommended for Information on page 438		
A3630006	SP 6	3	6	25		■	5
A3630008	SP 8	6	8	30		■	1

Handstones

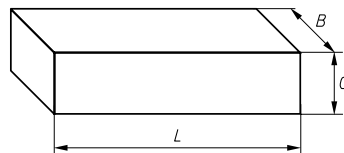

Ordering example: A20430000118

Further dimensions (see table below) and qualities on request.



PG 3

Product number	Description	Quality	L mm	B mm	C mm	Recommended for Information on page 438				
A20430000118	RU 1	SICGR 60 O V23/green=fine	50	25	15			9	■	5
A20430000122	RU 1	SICDKL 24 O V23/dark=coarse	50	25	15			9	■	5
A20430000218	RU 2	SICGR 60 O V23/green=fine	100	30	15			9	■	5
A20430000222	RU 2	SICDKL 24 O V23/dark=coarse	100	30	15			9	■	5
A20430000318	RU 3	SICGR 60 O V23/green=fine	100	50	25			9	■	5
A20430000322	RU 3	SICDKL 24 O V23/dark=coarse	100	50	25			9	■	5
A20430000418	RU 4	SICGR 60 O V23/green=fine	150	50	25			9	■	5
A20430000422	RU 4	SICDKL 24 O V23/dark=coarse	150	50	25			9	■	5
A2043150251608	RU 5	EKW 100 E (9) V40	150	25	16,5		3		■	5
A2043200502508	RU 6	EKW 100 E (9) V40	200	50	25		3		■	5

RU 1–4 is particularly suitable for

- profiling
- opening of pores
- sharpening
- dressing
of bonded grinding and polishing tools.

Available dimensions for handstones

Shape	length mm	width mm	height mm
	25	15	5–30
	44	35	18–30
	48	19	5–30
	50	25	10–35
	90	70	20–35
	100	30	10–35
	100	50	10–35
	120	10	5–35
	150	25	10–35
	150	50	10–35
	200	50	10–35
	216	78	20–35
	150	13	5–35

Tool-Set



Ordering example: A12390010

Assortment containing:
 8 pcs. Burrs of HSS
 8 pcs. Mounted points
 3 pcs. Polishing points
 6 pcs. Mounted flap wheels
 1 pc. Technical brush

Outside dimension of box:
 350 x 92 x 322 mm

PG 8

Product number	Description	piece	Contents	Recommended for	Information on page 438		
A12390010	WK 10	8 pcs.	Burrs of HSS MFA 1225.06, Z1 + Z3 MFC 1225.06, Z1 + Z3 MFD 1210.06, Z1 + Z3 MFM 1225.06, Z1 + Z3				
		8 pcs.	Mounted points ZY 0610.06, EKR ZY 1020.06, EKR ZY 1632.06, EKR ZY 1632.06, NK-BA-hard ZY 3208.06, NK-BA-hard SP 2032.06, EKR KU 1616.06, EKR KU 3232.06, EKR				
		3 pcs.	Polishing points P2ZY 1320.06, grit 120 P2SP 1320.06, grit 120 P2KU 1616.06, grit 120				
		6 pcs.	Mounted flap wheels SFL 03010.06, grit 120 SFL 04020.06, grit 120 SFL 06030.06, grit 80 SFL 06030.06, grit 120 SFV 04020.06, A 104 SFM 04020.06, A 104/80				
		1 pcs.	Technical brush BSSW 05010				

Tool-Set

Ordering example: A12390010

 Assortment containing:
 22 pcs. Burrs of HSS
 15 pcs. Mounted points
 7 pcs. Polishing points
 11 pcs. Mounted flap wheels
 3 pc. Technical brush

 Outside dimension of box:
 350 x 92 x 322 mm

PG 8

Product number	Description	piece	Contents	Recommended for	Information on page 438		
A12390020	WK 20	22 pcs	Burrs of HSS MFA 0616.06, Z1 + Z3 MFA 1225.06, Z1 + Z3 MFC 0620.06, Z1 + Z3 MFC 1225.06, Z1 + Z3 MFD 0605.06, Z3 MFD 1210.06, Z1 + Z3 MFD 1614.06, Z3 MFG 0618.06, Z1 + Z3 MFG 1230.06, Z1 + Z3 MFK 1230.06, Z3 MFM 0618.06, Z1 + Z3 MFM 1225.06, Z1 + Z3 MFW 0830.06				
		15 pcs	Mounted points ZY 0610.06, EKR ZY 0610.06, EKWbr ZY 1020.06, EKR ZY 1020.06, EKWbr ZY 1632.06, EKR ZY 1632.06, EKWbr ZY 1632.06, NK-BA-hard ZY 3208.06, EKR ZY 3208.06, NK-BA-hard SP 0816.06, EKR SP 2032.06, EKR TO 2020.06, EKR KU 0606.06, EKR KU 1616.06, EKR KU 3232.06, EKR				
		11 pcs	Mounted flap wheels SFL 03010.06, grit 60 SFL 03010.06, grit 120 SFL 04020.06, grit 60 SFL 04020.06, grit 120 SFL 06030.06, grit 40 SFL 06030.06, grit 80 SFL 06030.06, grit 120 SFV 04020.06, A 104 SFV 04020.06, A 106 SFM 04020.06, A104/80 SFM 04020.06, A 106/150				
		3 pcs	Technical brush BSSW 05010, BSSW 07018, BPSW 02525				
		7 pcs.	Polishing points P2ZY 0616.06, grit 120 P2ZY 1320.06, grit 120 P2ZY 1632.06, grit 120 P2ZY 3232.06, grit 120 P2SP 1320.06, grit 120 P2KU 1616.06, grit 120 P6MA 3030.06, SC 46 MWP				

Tool-Sets F10 S3 and F10 S6



Ordering example: A10390010

10 pieces

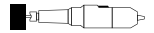

PG 1

Product number	Description	Image	Cut	Shank Ø mm	1 piece each	Recommended for Information on page 438		
A10390010	F10 S3		Z7 Steel	3	HFA 0313, HFA 0613, HFC 0313, HFC 0613, HFD 0302, HFD 0605, HFG 0313, HFG 0613, HFM 0613, HFF 0313	1 2 3 5 7	■	1
A1039001006	F10 S6		Z7 Steel	6	HFAS 0616, HFAS 1225, HFC 0616, HFC 1225, HFD 0605, HFD 1210, HFG 0618, HFG 1225, HFF 0820, HFF 1225	1 2 3 5 7	■	1

Tool-Sets



Ordering example: A1039001020

5 pieces and 10 pieces



PG 1

Product number	Description	Image	Cut	Shank Ø mm	1 piece each	Recommended for Information on page 438		
A1039001020	Assortment		Z42 Inox/ Steel	6	HFA 0616, HFA 1225, HFC 0616, HFC 1225, HFD 0605, HFD 1210, HFG 0618, HFG 1225, HFF 0618, HFF 1225	1 2 3 5 7	■	1
A1039000509	Assortment		Z9 Alu	3	HFA 0313, HFC 0313, HFD 0403, HFF 0313, HFG 0313	1 2 3 5 7	■	1
A10390005096	Assortment		Z9 Alu	6	HFA 0616, HFC 0616, HFM 0618, HFF 0618, HFD 0605	1 2 3 5 7	■	1

Tools-Sets Base-X F5

Ordering example: A10390053

PG 1

Product number	Description	Image	Shank Ø mm	Cut	Content	1 piece each	Recommended for Information on page 438									
A10390053	F5 S3 Tool-sets BASE-X		3	ZX	5-pieces HFA 0313, HFC 0313, HFD 0605, HFF 0313, HFG 0313		①	②	③	④	⑤	⑦			■	1
A10390056	F5 S6 Tool-sets BASE-X		6	ZX	5-pieces HFA 1225, HFC 1225, HFD 1210, HFF 1225, HFG 1225		①	②	③	④	⑤	⑦			■	1

Tool-Sets Burrs of HSS

★★☆



Ordering example: A1239000110

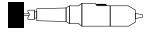

							PG 1						
Product number	Description	Image	Shank Ø mm	Cut	1 piece each	Recommended for Information on page 438							
A1239000110	F1		3	Z5	MF 807, MF 813, MF 841, MF 845, MF 850, MF 853, MF 864, MF 866, MF 872, MF 874	①	②		⑥			■	1
A12390003	F3		6	Z3	MFA 0616, MFA 1225, MFC 1225, MFD 0403, MFD 1210, MFE 1220, MFG 1230, MFH 1230, MFK 0620, MFM 0618	①	②		⑥			■	1
A12390004	F4		6	Z3/Z5	Z3 MFA 0616, MFA 1013, MFA 1225, MFC 1225, MFD 0807, MFD 1210, MFE 1220, MFE 1625, MFG 1220, MFG 1230, MFK 1230, MFL 1630, MFM 0618, MFM 1230, MFN 1213, MFN 1230 Z5 MFA 0304, MFA 0607, MFN 0303, MFN 0606	①	②		⑥			■	1

Mounted point-Assortment

★★☆



Ordering example: A204700001402



PG 3

Product number	Description	Image	Shank diameter mm	Quality	Content	1 piece each	Recommended for Information on page 438		
A204700001402	Assortment 14		3 x 30	EKR	14-pieces	ZY 0205, ZY 0306, ZY 0408, ZY 0510, ZY 0610, ZY 0810, ZY 0816, ZY 1010, ZY 1013, ZY 1313, KU 0808, ZY2 1303, ZY2 1604, ZY2 2006	① ② ③	■	1
A204600000202	Assortment 45		6 x 40	EKR	45-pieces	ZY 0306, ZY 0510, ZY 0408, ZY 0610, ZY 0810, ZY 0816, ZY 1010, ZY 1020, ZY 1032, ZY2 1303, ZY 1313, ZY 1320, ZY2 1604, ZY 1616, ZY 1620, ZY 1632, ZY2 2006, ZY 2020, ZY 2025, ZY 2032, ZY 2040, ZY2 2506, ZY2 2510, ZY 2520, ZY 2525, ZY 2532, ZY2 3208, ZY 3220, ZY 3232, ZY2 4010, ZY 4020, SP 0816, SP 1020, SP 1320, SP 2032, KE 1632, KE 1640, KE 2032, KE 2040, KU 1010, KU 1313, KU 1616, KU 2020, KU 2525, KU 3232	① ② ③	■	1

Mounted point-Assortment

★★☆

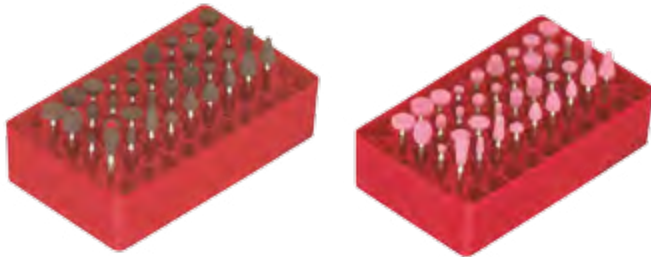

Ordering example: A204800003611

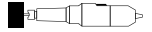

PG 3

Product number	Description	Image	Shank diameter mm	Quality	Content	1 piece each	Recommended for Information on page 438		
A204800003611	Assortment 36		3 x 30	EKBR	36-pieces	D1, D2, D3, D4, D5, D6, D7, D8, D9, D10, D11, D12, D13, D14, D15, D16, D17, D18, D19, D20, D21, D22, D23, D24, D25, D26, D27, D28, D29, D30, D31, D32, D33, D34, D35, D36	② ③	■	1
A204800003602	Assortment 36		3 x 30	EKR	36-pieces	D1, D2, D3, D4, D5, D6, D7, D8, D9, D10, D11, D12, D13, D14, D15, D16, D17, D18, D19, D20, D21, D22, D23, D24, D25, D26, D27, D28, D29, D30, D31, D32, D33, D34, D35, D36	① ② ③	■	1

Mounted points-Assortments, Quality NDW

★★★



Ordering example: A201000000353



PG 3

Product number	Description	Shank Ø mm	Quality	Contents	1 piece each	Recommended for Information on page 438		
A201000000353	Assortment 10	3 x 50	NDW	10-pieces	ZY 0408, ZY 0610, ZY 0810, ZY 1013, SP 0510, SP 0810, KU 0404, KU 0606, KU 0808, WR 1013	② ③	■	1

Assortment, Polishing points, group P1



Ordering example: A2600114

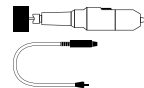

PG 3

Product number	Description	Contents	1 piece each	Recommended for Information on page 438		
A2600114	Assortment 114	14-pieces	P1ZY 0408.03; P1ZY 0510.03; P1ZY 0610.03; P1ZY 0710.03; P1ZY 0810.03; P1ZY 1010.03; P1ZY 1013.03; P1ZY 1016.03; P1ZY 1303.03; P1ZY 1313.03; P1ZY 1316.03; P1ZY 1604.03; P1ZY 1616.03; P1ZY 2006.03	<div style="display: flex; justify-content: space-around; text-align: center;"> 1 2 3 4 5 7 </div>	■	1

Abrasive caps-Assortments WS



Ordering example: A210000065

Assortment containing:
640 pcs. Abrasive Caps
23 pcs. Mandrels

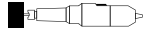

Outside dimension of box:
372 x 189 x 46 mm

NK = regular Aluminium Oxide

PG 9

Product number	Description	piece	Contents	Recommended for Information on page 438		
A210000065	WS 65	50 pcs. 100 pcs. of 50 pcs. of 20 pcs. of 10 pcs.	Abrasive Caps, grit NK 150 SKKE 0515 SKZY 0510, SKWR 0511, SKWK 0511 SKZY 0712, SKWR 0713, SKWK 0713 SKZY 1015, SKWR 1015 SKKE 1125 Abrasive Caps, grit NK 80 SKWK 1015 SKZY 1317, SKWR 1319, SKWK 1319, SKKE 1632 SKWK 1626, SKWR 1626 Mandrels, Shank 3 mm GTZY 0510, GTWR 0511, GTWK 0511, GTZY 0712, GTWR 0713, GTWK 0713 GTZY 1015, GTWR 1015, GTWK 1015, GTZY 1317, GTWR 1319, GTWK 1319 Mandrels, Shank 6 mm GTKE 0515, GTKE 1125, GTWK 1626, GTWR 1626, GTKE 1632	① ② ③ ④ ⑤ ⑥ ⑦ ⑧	■	1

A

Abrasive and diamond pastes	145
Abrasive Bands and Mandrels	277
cylindrical	279
conical shape	287
Abrasive Bands and Mandrels for grinding rolls	288
Abrasive Caps	297
cylindrical shape	299
cylindrical round nose	301
cylindrical pointed nose	303
conical round nose	305
conical shape	307
Abrasive caps-Assortments	308
Abrasive Discs	309
quick-change	342
quick-change with plastic thread	319
self-adhesive	322
self-fixing	324
Abrasive Mandrels	295
Abrasive Rolls	291
Accessories	418
Arbors for felt polishing wheels	418
Arbors for tools with internal thread	419
Mounting arbors for small cutting-off wheels	419
Mounting system for polishing wheels	418
Adapter	420
Reducing bush	420
Handstones	421
Adaptor for SFA	420
Adaptor for SFI	420
Air Tools	369
Alu – Burrs for non-ferrous metals	27
Arbors for felt polishing wheels	143
Arbors for tools with internal thread	419
Arbors Mounting arbors for small cutting-off wheels	419
AS-cleaning fleece	365

B

Backing Pad for fibre discs	336
Bands and Rolls/Caps and Sleeves	300
cylindrical shape	300
cylindrical round nose	302
cylindrical pointed nose	304
conical round nose	306
conical shape	307
Belt grinder	372
Big Cutting discs (greater than 230 mm)	183
Brushes	353
Burrs of HSS	65
Cylindrical	70
Cylindrical round nose	71
Spherical	72
Oval	73
Arch pointed nose	74

Flame	74
Club	75
Round nose	75
Pointed nose	76
Inverted	76
Cylindrical multiple concave burr	77
Miniature Burrs	78
Burrs with internal thread	81
Tool-sets	82
Burrs of HSS	65

C

Cast – Burrs for cast material	28
CBN- and diamond tools for precision machining	383
CBN-Points electro-plated	393
CBN-Points vitrified bonded	387
Cleaning fleece	365
Compact grinding disc – Purple Grain	203
Composite Burrs	30
Conditioning Machine	382
Cutting Discs	173
for stainless steel	176
for metal	180

D

Diamond Cup Wheels	350
Diamond Cutting Discs	344
Diamond dry drill	351
Diamond Files electro plated	397
Diamond Paste	145
Diamond-Points, electro-plated	393
Diamond-Points, vitrified bonded	387
Diamondtools	341
Disc Carriers	317
quick-change	317
quick-change with plastic thread	321
for self-adhesive abrasive discs	323
for self-fixing abrasive discs	325
Drill bit for socket outlets	352

E

Economy Rolls	337
Electric power tool	382
Engraving Cutters	39
Engraving Cutters of solid carbide	87

F

Felt Polishing Points, group P3	140
Felt polishing wheels	143
Fibre Discs	331
Filing Discs in WS	83
Filing Rings in WS	83
Flap Rolls	269
of abrasive cloth	271

of abrasive fleece	272	Flap wheels of abrasive cloth, with internal thread	248
of abrasive fleece for conditioning machines	267	Flap wheels of abrasive cloth, with external thread	249
abrasive fleece/abrasive cloth combination	274	Mini-Flap wheels of abrasive cloth	250
Flap Wheels	259	Mounted Flap Wheels of abrasive Fleece	251
of abrasive cloth	262	Flap wheels of fleece flaps	253
of abrasive fleece	263	Mounted fleece discs	256
abrasive fleece/abrasive cloth combination	266	Flap wheels of abrasive fleece with abrasive cloth	256
Fleece Rolls	339	Mounted Points	91
Fleece Rolls	339	Qualities and areas of application	94
Free-hand cutting disc for angle grinders	176	Summary of available shapes	97
G		Cylinder	104
<hr/>		Cylindrical pointed nose	112
Grinding Discs	185	Pointed nose	113
for stainless steel	188	Spherical	115
for metal	190	Conical round nose	117
for cast iron	191	Cylindrical round nose	114
for stone and cast iron	192	American shapes A	119
H		American shapes B	120
<hr/>		Miniatuur-Mounted points	120
Handstones	421	Handstones	124
L		Points-Assortments	125
<hr/>		Mounted points special for your particular application	128
Lamellar Flap Discs	199	Mounting arbor for AS-cleaning fleece	367
Purple Grain	212	Mounting device for grinding rolls	288
SLTT	204	Mounting system for polishing wheels	154
V2 POWER	208	N	
V4 Purple Power	212	<hr/>	
V4 Master	214	NAWAROFLEX, Flap Discs	227
SLTflex	216	P	
SLTs-flex	218	<hr/>	
SLTR Control with see through zone	220	Pneumatic Air Tools	372
SLTZ with grinding additives	220	Polishing disc P6PT	158
SLTO/SLTR on fibre backing	221	Polishing Points	129
SLTB on steel backing	225	group P1	133
SLTK on plastic backing	226	group P2	136
SLTC, SLTM, SLTV NAWAROFLEX	227	group P3	140
SLTP for finishing an polishing	229	Felt polishing wheels	140
P6PT	229	Arbors for felt polishing wheels	140
SLTG	232	Abrasive and diamond pastes	144
Linishing belts	269	group P4	146
M		group P5	148
<hr/>		group P6	151
Mandrels	285	Mounting system for polishing wheels	154
cylindrical	285	Conditioning machine	382
conical shape	287	group P7	161
Marbling points group P6	155	Polishing Points group P4	146
Mounted Flap Wheels	235	Polishing rolls	157
Mounted Flap Wheels Ceramic	237	Purple Grain	202
Mounted Flap Wheels of abrasive Cloth	238	Purple Power	212
Slotted flap wheels	236	R	
Flap wheels – recessed	246	<hr/>	
Flap wheels of abrasive cloth regular aluminium oxide,	247	Rasp burrs for Wood	32
special bond		Reducing bushes	420
Flap wheels of abrasive cloth, silicon carbide	248	Rolls manufactured	267
		Rotary files	33

S

Sheets of abrasive cloth	398
Small polishing points group P7	161
Small polishing points group P7	161
Straight Grinder	373

T

Technical Brushes	353
Cylindrical brush with shank	355
Cylindrical brush of abrasive nylon	355
Conical brushes	356
End brush with shank	356
pipe brush	357
pipe brush of abrasive nylon	357
Wheel brush	358
Twist knot wheel brush	358
Cup brush, with thread	359
Hand brush	360
Tool-sets	422
Trimming burrs	46
Tungsten Carbide Burrs	17
Burrs with TiAlN-coating	23
Burrs for Inox and steel	24
Burrs for machining steel	25
Burrs for non-ferrous metals	27
Burrs for Cast material	28
Burrs for machining Composite materials	30
Rasp burrs for machining Wood	32
Rotary files	33
Miniature Burrs	34
Miniature burrs	35
Burrs with extended shank length	37
Trimming burrs	60
Tool-sets	61
Tools for stationary use	63
Cylindrical	40
Cylindrical round nose	43
Spherical	46
Oval	49
Arch round nose	50
Arch pointed nose	52
Flame	54
Internal	54
Pointed nose	55
Conical round nose	55
Conical pointed nose	57
Inverted cone	58
Tungsten Carbide Burrs	17
Tungsten Carbide Granulate tipped Tools	163
Tungsten Carbide Granulate tipped discs	165
Core Drill-Set	165

V

V2 Power	208
V4 Master	214
V4 Purple Power	212

W

Wood - Rasp burrs	32
-------------------	----

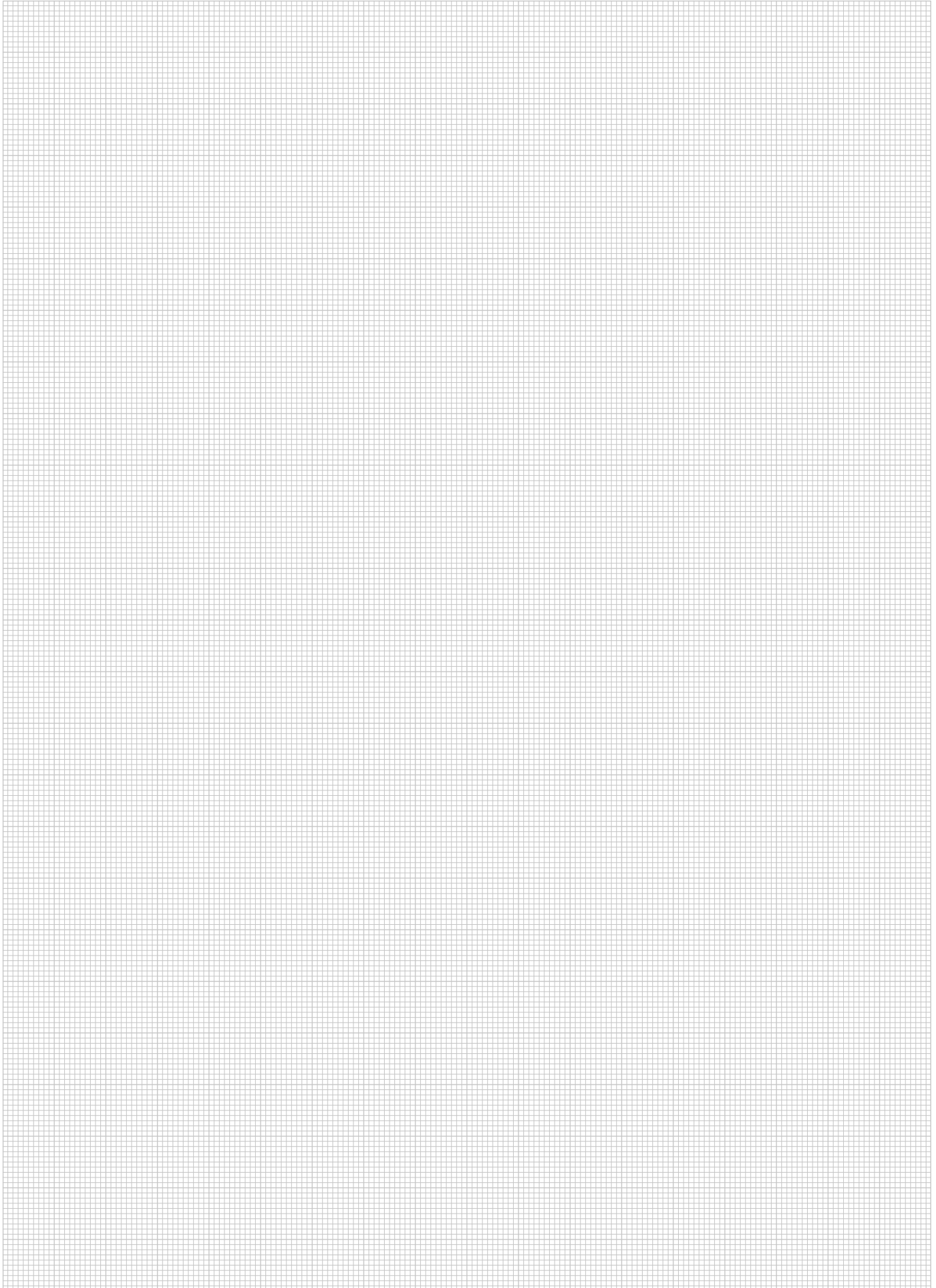

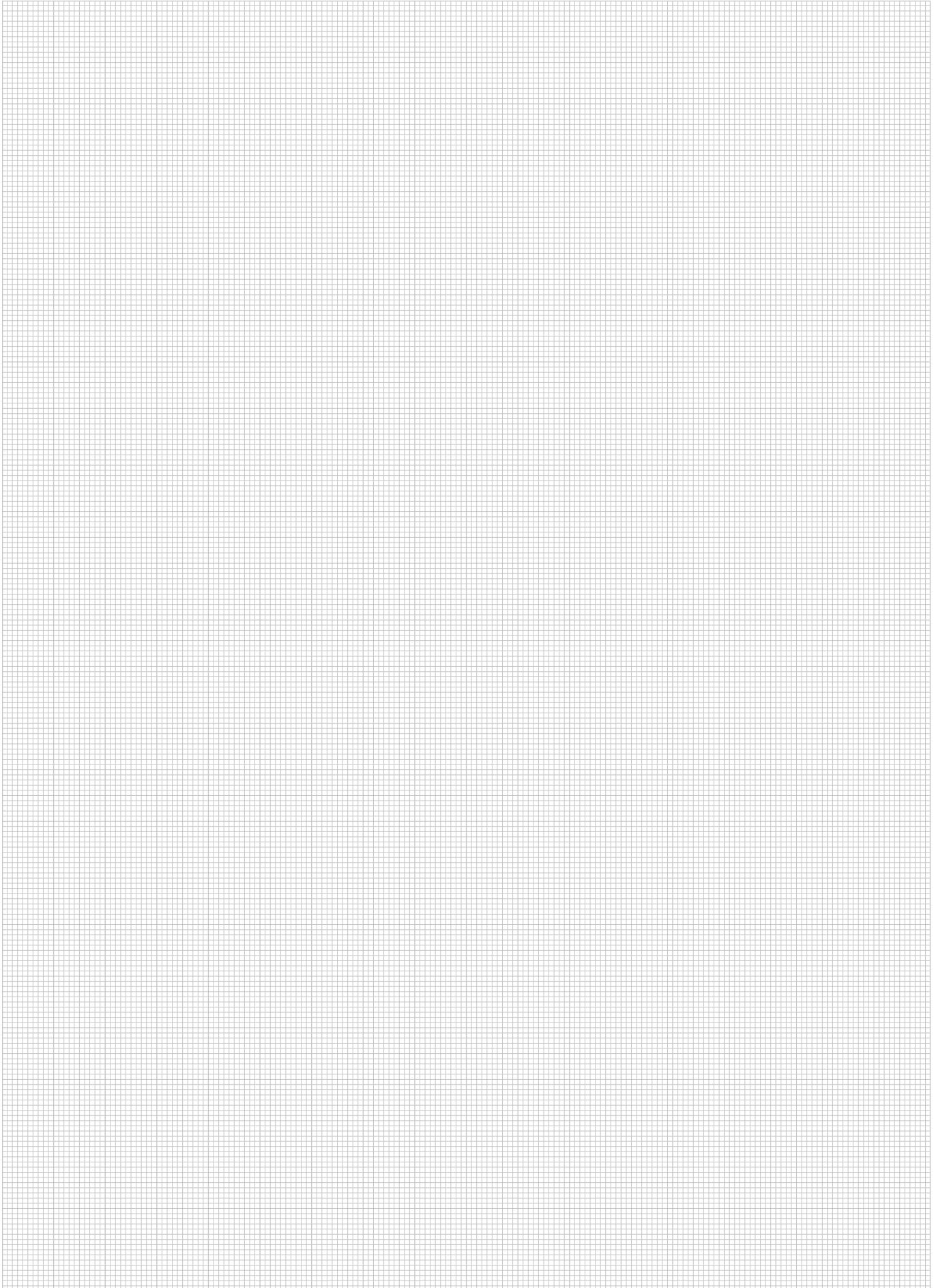

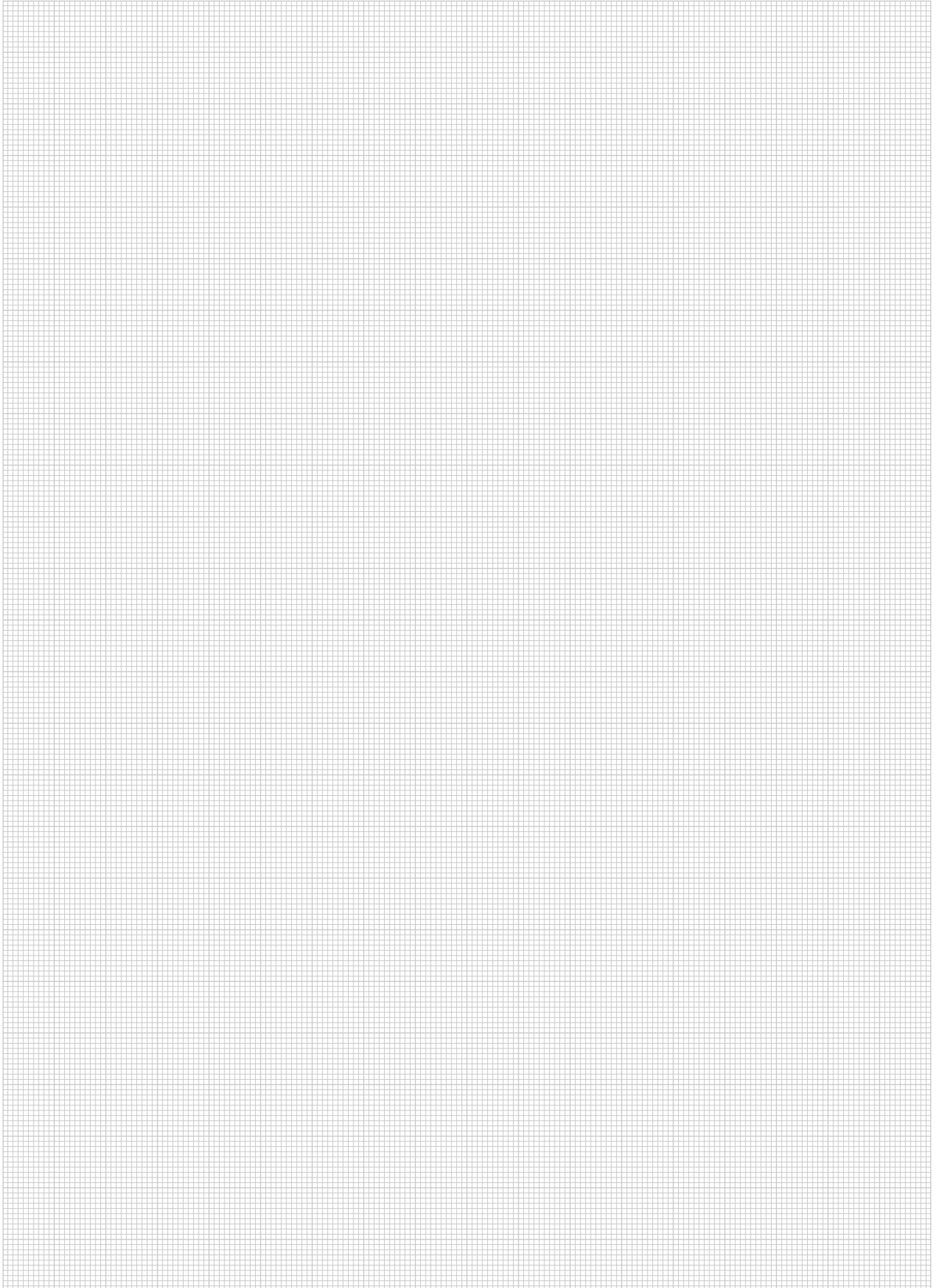

Terms and Conditions of Quotation, Delivery and Payment

I. Scope

1. The following terms and conditions are final and are an integral part of the contract. They shall apply to all (past and future) contracts and other services. All quotations are exclusively based on our terms and conditions and they shall be deemed as having been accepted through the placement of an order or acceptance of a delivery. Any terms and conditions of the Buyer which conflict with or deviate from our contractual conditions shall not place us under any obligation even if we do not expressly contradict them following receipt.
2. There are no verbal collateral agreements. Any collateral agreements, deviations or modifications shall only be binding when confirmed by us in writing. This applies in particular to any agreements concerning the nature of a product.
3. These terms and conditions only apply to enterprises

II. Quotations

1. Our quotations are submitted without commitment. The documents accompanying the quotation such as drawings, illustrations, technical data, references to standards as well as information in brochures are not agreements concerning the nature of a product unless they are expressly designated as such in writing.
2. Our patterns and samples and our information on the composition and nature of our products are based on our experience and expertise. However, they are not guaranteed nor is any other assurance binding upon us.
3. We shall retain title and copyright to brochures, illustrations, drawings, diagrams and other documents; they shall not be reproduced, copied from the Internet or made accessible to third parties without our consent and shall be returned to us without delay on request.

III. Contract conclusion

1. An order shall be deemed to have been accepted if it is acknowledged by us in writing or the goods are dispatched.
2. The order acknowledgment shall define the contents and scope of the order. Supplements, amendments or verbal collateral agreements require our written confirmation to become effective.
3. The Buyer shall be responsible for the correctness of the documents to be provided by him, such as drawings, specimens and the like. Verbal information on dimensions and the like shall be subject to our written confirmation.

IV. Prices

1. Our prices are in EURO for delivery ex works Engelskirchen excluding packaging, freight, postage, customs fees and insurance. Surcharges and discounts shall be calculated on the basic price in each case. The same shall apply to partial consignments and express deliveries requested by the Buyer. €
2. The minimum order value is € 130 net. For orders with a value of less than € 130 net a handling fee of € 15 will be charged.
3. The prices shall be subject to VAT at the current rate.
4. The prices as stated in the order acknowledgement shall be valid for a delivery period of up to four months; in the case of longer delivery periods, the prices ruling on the date of delivery shall apply if our cost price, e.g., material costs, wages or other production costs have changed.

V. Terms of payment

1. Our invoices shall be due within 14 days from the date of invoice less 2% discount or 30 days net. Payment shall be made within these deadlines so that the invoiced amount is available to us not later than on the due date.
2. When the time scheduled for payment is exceeded without payment having been made, we will charge interest on the sum owed at a rate of 8% above the basic rate of interest of the European central bank. We reserve the right to claim higher damages as a result of a default in payment.
3. Initial deliveries shall always be made against cash in advance or cash on delivery.
4. Bills of exchange (acceptance only if agreed in writing) and cheques shall only be accepted on account of performance. Discount and collection charges shall be borne by the Buyer. We accept no liability for punctual presentation.
5. If we have justified doubt concerning the ability of the Buyer to be able to keep up proper payment, e.g. insolvency proceedings, imminent discontinuation of payment or a serious deterioration in the financial circumstances of the Buyer, we shall be entitled to hold back deliveries not yet made. In such a case we may decide that all our claims will immediately become due for payment without considering the terms of any cheques that may have been accepted or we may set the Buyer a reasonable deadline for payment against delivery or for the provision of a form of security and, if the deadline passes without results, to withdraw from the further performance of our contractual obligations. If a petition in bankruptcy of the Buyer has been filed, we may immediately withdraw from the contract. This shall not release the Buyer from his obligations arising from parts of the contract we have already fulfilled, former contracts or contracts which have not yet been carried out.
6. We reserve the right to assign claims.
7. The Buyer shall only have the right of setoff, if his counterclaims have become res judicata, are undisputed or have been recognised by us. Furthermore, the Buyer shall be entitled to exercise a right of retention insofar as his counterclaim is due and associated with the same contractual relationship.

VI. Reservation of title

1. The goods delivered shall remain our property („retention of title goods“) until full payment of all (also future) claims including all ancillary claims (e.g. costs of bills, financing costs, interest etc.) arising from the business relationship between us and the Buyer. Payment shall be deemed to have been made when we receive the sum due.
2. The Buyer must treat the retained title goods with care. We shall be entitled to insure the goods, at Buyer's expense, against theft, breakage, fire, water and other damage, provided that the Buyer is unable to verify he has taken out such insurance himself.
3. The Buyer shall be entitled to process or mix and sell the goods in the normal course of business. The processing or conversion of the goods by the Buyer shall always be performed on our behalf. If the goods are processed to incorporate other items which do not belong to us, we shall acquire joint ownership of the new article in the ratio of the value of the contract goods to the other processed items involved at the time of processing. The same shall apply to the items produced by processing the goods delivered in respect of reservation of title.
4. If the Buyer sells the goods before payment of all secured claims, he shall assign to us his claims against his customers or against third parties arising from the resale on conclusion of the supply contract as security for the claim secured by the goods. We will accept assignment. We herewith authorise the Buyer, until such authorisation is revoked, to collect the assigned claims. We shall be entitled to revoke such authorisation if our secured claims are jeopardised, in particular if the Buyer defaults on his payments. The collection authorisation shall expire ipso jure at the time when the Buyer discontinues his payments or files a petition in bankruptcy. After the revocation or expiry of the collection authorisation we shall be entitled and the Buyer shall be obliged to report the assignment to the debtor of the assigned claim. The Buyer shall refrain from collection but, nevertheless, keep any sums received for us separate. The Buyer shall, at our request at any time, inform us in writing to whom he has sold the goods and shall provide all information and documents relating to the assigned claim.
5. We undertake to release the securities due to us at the Buyer's request insofar as the value of our securities exceeds the claims to be secured by more than 20%; and we shall be free to select the securities to be released.
6. Extraordinary disposal such as pledges or chattel mortgages require our approval. The Buyer shall inform us in writing without delay of any pledging or other interventions by third parties and shall provide us with all information and documents which may be required to protect our rights. This also applies if such measures are pending. The executing officer or third parties must be notified of our property. The Buyer shall bear all costs which arise as a result of abrogating access and recovering retention of title goods unless these can be recovered from third parties.

7. If the Buyer behaves in a manner which is contrary to the provisions of contract, in particular if he is in default of payment, we may, after a reminder, recover the items sold, and the Buyer shall deliver same. If we withdraw from the contract in the event of a petition in bankruptcy according to clause V. 5, we may request immediate restitution of retention of title goods.

VII. Delivery periods

1. The delivery period may be agreed as being binding or without commitment and shall be confirmed in writing. It shall not commence before the receipt of the documents and releases to be obtained by the Buyer and before the receipt of any agreed down payment and compliance with all other obligations of the Buyer.
2. The delivery period shall be deemed to have been observed if, before it has expired, the goods have left our works or notification has been given that the goods are ready for dispatch. The delivery period shall be prolonged by a reasonable period - also during a delay in delivery - if unforeseen hindrances occur which we are unable to avoid despite due care being taken under the circumstances, regardless of whether such hindrances occur at our works or at one of our subcontractors' works, who is therefore unable to supply us in good time, e.g. disruptions to operations, effects of action during labour disputes or similar. If delivery or service becomes impossible owing to the above-mentioned circumstances, we shall be released from our delivery obligations.
3. The delivery period shall in particular be extended if and when we are unable to observe the delivery date due to untimely or incorrect delivery by our own suppliers to us. This shall apply under the premise that we had closed a corresponding deal with our supplier to cover our supply needs for the contract at the time of conclusion of the contract with the Buyer. We will submit documentation of timely conclusion of such contract upon request by Buyer.
4. Should delivery or performance become impossible due to the circumstances listed above under items 2. and 3. or should delivery be delayed by more than six weeks, both the Buyer and we shall be entitled to rescind this contract without incurring any liability for damages.
5. We may make partial deliveries to a reasonable extent.

VIII. Scope and performance of delivery; transfer of risk

1. Our delivery note shall define the scope of the delivery. One packing unit shall be the minimum order quantity.
2. Quantity discrepancies shall be reported in writing within 8 days of receipt. 3. Stocked goods listed in catalogues shall be delivered in the specified packing units. We reserve the right to change the packing units.
4. For production reasons, excess and short deliveries of up to 15% shall be admissible for products which are not kept in stock.
5. We reserve the right to make technical changes to our products in line with ongoing research and development.
6. The risk in all business transactions, including carriage paid deliveries, shall pass to the Buyer on the handover of the goods to a forwarding agent or carrier but at the latest when the goods leave the warehouse or - with direct shipment business - the supplier's works. We shall take out insurance against transport damage at the express request of the Buyer and at his expense.
7. In the case of call-off orders, deliveries shall be made on the Buyer's call-off. The deadline for acceptance shall be 12 months from the date of the order acknowledgment. We shall be entitled to produce the entire order quantity in one batch. Any requests for changes may no longer be allowed for after the order has been placed, unless this has been expressly agreed. Amounts which have not been called off at the time of expiry of the aforementioned period shall be sent to the Buyer at that time and invoiced.

IX. Claims Based on Defects

1. For the assertion of claims based on defect, the Buyer must have complied with his examination and notification obligations arising from the commercial code. If the goods are defective, we undertake, at our discretion to supply items free from defects (replacements) or to rectify the defects. In the event of a rectification of defects, we shall bear all costs required to rectify the defect unless such costs are increased by the fact that the item is delivered to another place than the place of performance. If rectification of defects or replacement fails, the Buyer may at his discretion withdraw from the contract or reduce the purchase price. Generally the Buyer has to accept two replacement or rectification attempts.
2. We shall be liable for replacement deliveries and rectification to the same extent as for the original goods delivered. For replacement deliveries the statute of limitations for claims based on defects shall commence anew. The statute of limitations is 12 months. It begins running on the date of delivery of the goods to the Buyer.
3. No liability shall be assumed for damage which has occurred for the following reasons: Unsuitable or improper storage and use, incorrect assembly and/or commissioning by the Buyer or third parties, natural wear and tear, improper or negligent handling, inappropriate process materials, chemical, electrochemical or electrical influences, provided that they are not our fault. We shall have no liability for any changes or repair work undertaken by the Buyer or third parties improperly without our prior consent and for any consequences resulting therefrom.

X. Liability

1. We are liable for the full extent of damage in the event of intentional behaviour by us and by our executives and in the event of gross negligence through our own fault or through the fault of our vicarious agents. In addition, we are fully liable in the case of non-observance of guarantees, when taking a procurement risk and in case of other definite promises, in the case of culpable injury to life, body and health and under the product liability law. In the case of culpable violation of essential contractual obligations, i.e. principal obligations which enable the proper execution of the contract and upon which the Buyer therefore relies and may rely, we undertake liability on the merits. Our liability shall be limited to damage which is typical for the contract and which can be reasonably foreseen. Any liability beyond the above limits is explicitly excluded.
2. Insofar as our liability is excluded or limited, the same applies to the personal liability of our employees, employees' representatives and agents.
3. These provisions are not aimed at reversal of the burden of proof.

XI. Return and exchange €

The Buyer shall be entitled to return and exchange items within four weeks after delivery without giving a reason therefore and by providing us with our commission number. The goods shall be returned carriage paid. The right to return and exchange shall be without prejudice to Buyer's claims based in defects pursuant to item IX. herein.

We shall charge € 25 for the processing costs thus incurred.

Special designs may not be returned.

XII. Place of performance, venue, applicable law, partial invalidity, data protection

1. Engelskirchen shall be the place of performance for all obligations of both parties arising from the contract.
2. The venue for all disputes with buyers who are merchants as defined by German law, legal entities subject to public law or institutions bound by public law shall be the court having jurisdiction over our domicile. However, we reserve the right to bring legal action at the Buyer's domicile.
3. German law shall apply to cross-border deliveries. International conventions on the sale of goods (e.g. United Nations Convention On Contracts For The International Sale Of Goods) shall not apply. 4. If individual provisions of the contract or of these conditions are invalid, the remaining provisions shall continue to be effective and binding. In the event of partial invalidity of an individual provision, the remainder of such a provision shall remain effective.
5. In accordance with Section 33 (1) of the Federal Law on Data Protection, we point out that we store and use all customer and supplier related data using electronic data processing.

Material classification

1 Steels and Cast Steels

Rm up to 800 N/mm²

- common structural steels
- free cutting steels
- case hardened steels
- fine grained structural steels
- extruded steels
- toughened structural steels
- boiler plate
- nitrided steels
- cast steels
- heat treated steels
- heat resistant structural steels

2 Alloyed, Tempered Steels

Rm 800 up to 1200 N/mm²

- case hardened steels
- spring steels
- fine grained structural steels
- nitrided steels
- heat treated steels
- wear resistant steels
- bearing steels

3 Tool Steels

Rm up to 1300 N/mm²

- 60–65 HRC
- high-speed steels
- non-alloyed tool steels
- cold working tool steels
- hot working tool steels

4 Rust, acid and heat resistant Steels and Cast Steels

- austenitic
- ferritic
- ferritic-austenitic
- heat-resistant
- martensitic
- stainless, sulphurized

5 Cast Iron

6 Aluminium, Magnesium and Copper Alloys

- over 300 HB
- 200–300 HB
- up to 200 HB
- over 15% Si
- 10–15% Si
- 0,5–10% Si
- below 0,5% Si

7 Titanium and Nickel Alloys

- Rm 900 up to 1500 N/mm²
- Rm up to 900 N/mm²

8 Plastics, Wood, Rubber

9 Glass/Carbides

10 Stone/Tiles/Gas Cement

11 Concrete/Reinforced Concrete

12 Ceramic/Floor Tiles

13 Marble

14 Granite

15 Freshly Poured Concrete

16 Asphalt

- best suitable
- suitable

- delivery ex-stock
- ▲ delivery on request

Power tools

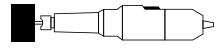

Straight grinder

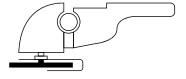

Free-hand angle grinder

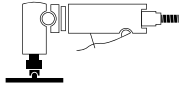

Pneumatic angle grinder

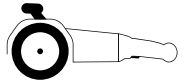

Conditioning machine

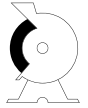

Backstand

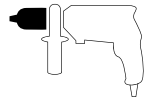

Boring machine

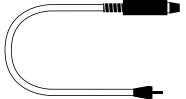

Flexible shaft grinder

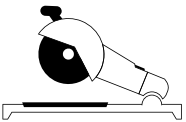

Fixed-base cutting machine

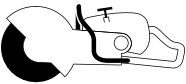

Petrol-driven cutting machine

Product Lines

★★★ High Performance

★★☆ Industry

★☆☆ Base

Safety Symbols

(Depending on the product these symbols may vary)



Wear eye protection



Wear hearing protection



Wear a respirator



Read the instructions



Wear gloves



Only permitted with a back-up pad



Not permitted for wet grinding



Not permitted for face grinding



Do not use if damaged



Not permitted for hand-held or manually-guided grinding

Conditions

List prices quoted are ex-works Engelskirchen excluding packing and value added tax. Surcharges and discounts will be individually applied to the list price. This price list is for the sole use of the recipient, and duplication in part or whole for a third party is not permitted. In all other aspects, our general terms and conditions apply as detailed on the last page.

Minimum order value

130,- € net

For orders below 130,- € net we have to invoice 15,- € handling charge.

Terms of payment

14 days less 2 % cash-discount or 30 days net.

Minimum order quantity

Packing unit

Special production

Minimum quantity/-order quantity on request. For production reasons, excess and short deliveries of up to 15 % of the ordered quantity shall be admissible for products which are not available ex stock.

Call-off order

Call-off orders can cover a maximum period of 12 months from the date of acknowledgement. We have the right to manufacture the complete order, and any quantity not taken by the end of the contract period will be despatched and invoiced in full.

Returns and exchanges

Any returns or exchanges, for whatever reason, must be received by us carriage paid within 4 weeks after receipt, stating batch number under which the goods were supplied. In such events, a handling charge of 25,- € will apply.

Technical alterations

We reserve the right to make any technical alterations to our products resulting from our continuous research and development programme.

Please note the contents of this and the last page to avoid any dispute.

Misprints reserved.

www.lukas-erzett.com



LUKAS-ERZETT Vereinigte Schleif- und Fräswerkzeugfabriken GmbH & Co. KG

Gebrüder-Lukas-Straße 1

51766 Engelskirchen (Germany)

Fon +49 2263 84-0

Fax +49 2263 84-327 (Domestic Market)

Fax +49 2263 84-300 (Export Department)

le@lukas-erzett.de

www.lukas-erzett.com

VAT No. DE 8128 5590 7



Production plants and Sales offices

LUKAS Headquarters, Engelskirchen

LUKAS CZ spol. s. r. o.

Tovární 478

35134 Skalná

Fon +420 357 070600

Fax +420 357 070613

obchod@lukascz.cz

www.lukas-erzett.com

LUKAS ABRASIVES SA (PTY) LTD.

1288 Harriet Avenue

Driehoek

1401 Germiston

Fon +27 11 8251550

Fax +27 11 8720144

abrasives@lukas.co.za

www.lukas.co.za

Kayson Green Limited

Clough Road

Severalls Business Park

Colchester

CO4 9QS Essex

Fon +44 1206 751500

Fax +44 1206 751212

abrasives@kaysongreen.co.uk

Beijing Representative Office

Room 2228

19th Floor

C-King Apartment

No. 19 Madian East Rd.

100080 Haidian District Beijing

Fon +86 10 82961338

Fax +86 10 82800015

beijing@lukas-erzett.com.cn

LUKAS-ERZETT Vereinigte Schleif- und Fräswerkzeugfabriken GmbH & Co. KG

Avd. de la Azucarera, Nave 14

28500 Arganda del Rey (Madrid)

Fon +34 900 974924

Fax +34 900 974925

le@lukas-erzett.de

www.lukas-erzett.com